

# FOREWORD

This wiring diagram manual has been prepared to provide information on the electrical system of the 1995 LEXUS GS300.

Applicable models: JZS 147 Series

For service specifications and repair procedures of the above models other than those listed in this manual, refer to the following manuals:

Manual Name	Pub. No.
<ul style="list-style-type: none"><li>1995 LEXUS GS300 Repair Manual Volume 1 Volume 2</li></ul>	RM406U1 RM406U2
<ul style="list-style-type: none"><li>1995 LEXUS New Car Features</li></ul>	NCF110U

All information in this manual is based on the latest product information at the time of publication. However, specifications and procedures are subject to change without notice.

**TOYOTA MOTOR CORPORATION**

## NOTICE

**When handling supplemental restraint system components (removal, installation or inspection, etc.), always follow the direction given in the repair manuals listed above to prevent accidents and supplemental restraint system malfunction.**

# INTRODUCTION

---

This manual consists of the following 11 sections:

No.	Section	Description
A	INDEX	Index of the contents of this manual.
	INTRODUCTION	Brief explanation of each section.
B	HOW TO USE THIS MANUAL	Instructions on how to use this manual.
C	TROUBLE-SHOOTING	Describes the basic inspection procedures for electrical circuits.
D	ABBREVIATIONS	Defines the abbreviations used in this manual.
E	GLOSSARY OF TERMS AND SYMBOLS	Defines the symbols and functions of major parts.
F	RELAY LOCATIONS	Shows position of the Electronic Control Unit, Relays, Relay Block, etc. This section is closely related to the system circuit.
G	ELECTRICAL WIRING ROUTING	Describes position of Parts Connectors, Splice points, Ground points, etc. This section is closely related to the system circuit.
H	POWER SOURCE (Current Flow Chart)	Describes power distribution from the power supply to various electrical loads.
I	INDEX	Index of the system circuits.
	SYSTEM CIRCUITS	Electrical circuits of each system are shown from the power supply through ground points. Wiring connections and their positions are shown and classified by code according to the connection method. (Refer to the section, "How to use this manual"). The "System Outline" and "Service Hints" useful for troubleshooting are also contained in this section.
J	GROUND POINTS	Shows ground positions of all the parts described in this manual.
K	OVERALL ELECTRICAL WIRING DIAGRAM	Provides circuit diagrams showing the circuit connections.

This manual provides information on the electrical circuits installed on vehicles by dividing them into a circuit for each system.

The actual wiring of each system circuit is shown from the point where the power source is received from the battery as far as each ground point. (All circuit diagrams are shown with the switches in the OFF position.)

When troubleshooting any problem, first understand the operation of the circuit where the problem was detected (see System Circuit section), the power source supplying power to that circuit (see Power Source section), and the ground points (see Ground Points section). See the System Outline to understand the circuit operation.

When the circuit operation is understood, begin troubleshooting of the problem circuit to isolate the cause. Use Relay Location and Electrical Wire Routing sections to find each part, junction block and wiring harness connectors, wiring harness and wiring harness connectors, splice points, and ground points of each system circuit. Internal wiring for each junction block is also provided for better understanding of connection within a junction block.

Wiring related to each system is indicated in each system circuit by arrows (from \_\_ , to \_\_ ). When overall connections are required, see the Overall Wiring Diagram at the end of this manual.

# HOW TO USE THIS MANUAL

\* The system shown here is an EXAMPLE ONLY. It is different to the actual circuit shown in the SYSTEM CIRCUITS SECTION.

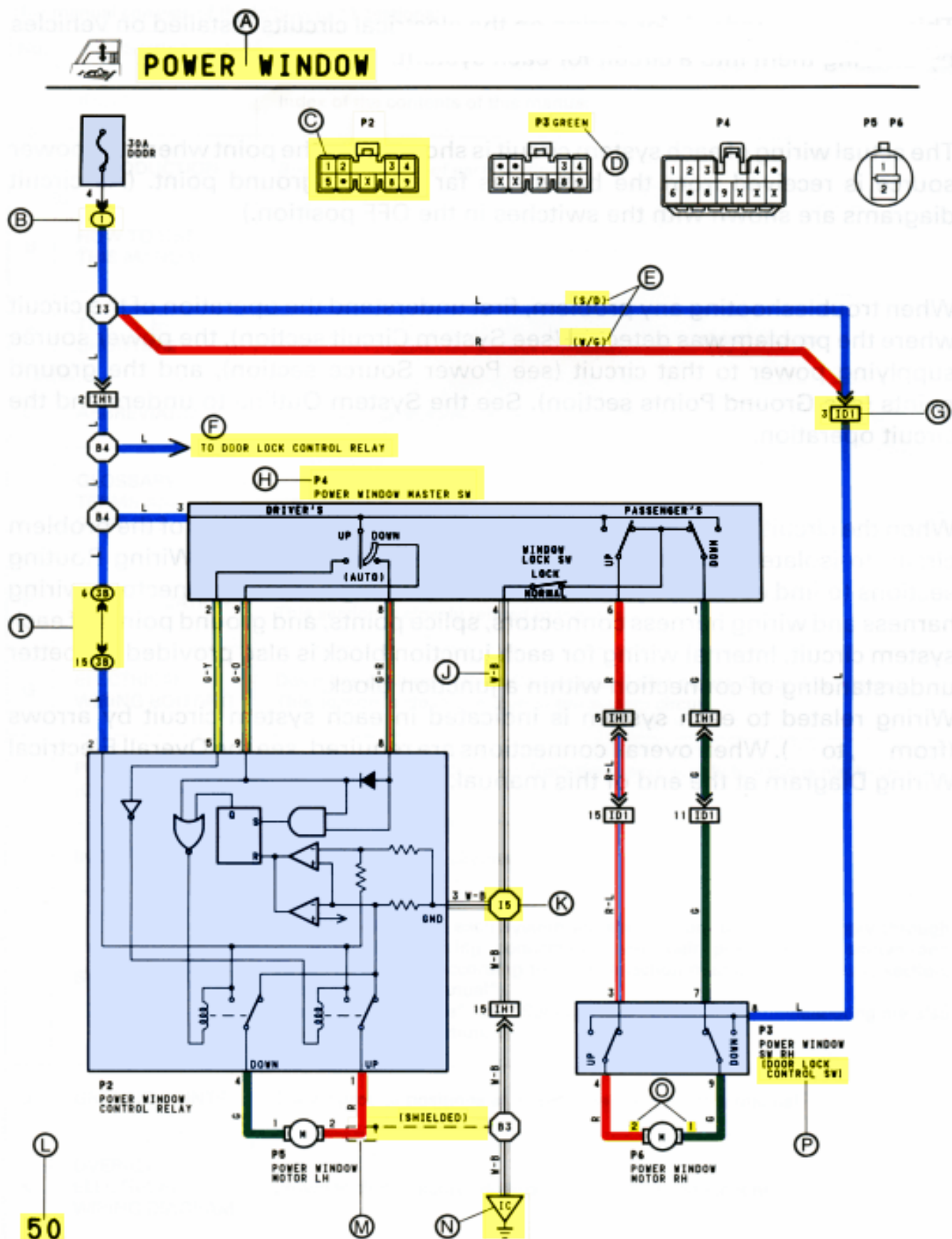

- (A) : System Title
- (B) : Indicates a Relay Block. No shading is used and only the Relay Block No. is shown to distinguish it from the J/B.

Example:  Indicates Relay Block No. 1.

- (C) : Indicates the connector to be connected to a part (the numeral indicates the pin No.)
- Explanation of pin use.

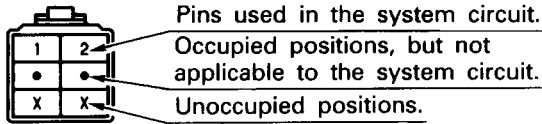

The pins shown are only for the highest grade, or only include those in the specification.

- (D) : Connector Color  
Connectors not indicated are milky white in color.
- (E) : ( ) is used to indicate different wiring and connector, etc. when the vehicle model, engine type, or specification is different.
- (F) : Indicates related system.
- (G) : Indicates the wiring harness and wiring harness connector. The wiring harness with male terminal is shown with arrows (↗).

Outside numerals are pin numbers.

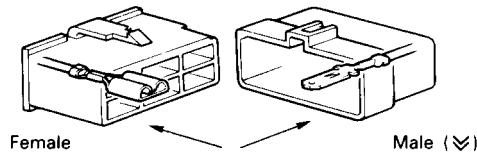

The first letter of the code for each wiring harness and wiring harness connector(s) indicates the component's location, e.g., "E" for the Engine Compartment, "I" for the Instrument Panel and Surrounding area, and "B" for the Body and Surrounding area.

When more than one code has the first and second letters in common, followed by numbers (e.g., IH1, IH2), this indicates the same type of wiring harness and wiring harness connector.

- (H) : Represents a part (all parts are shown in sky blue). The code is the same as the code used in parts position.
- (I) : Junction Block (The number in the circle is the J/B No. and the connector code is shown beside it). Junction Blocks are shaded to clearly separate them from other parts (different junction blocks are shaded differently for further clarification).

Example:

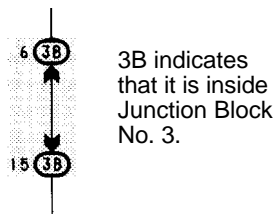

- (J) : Indicates the wiring color.  
Wire colors are indicated by an alphabetical code.  
B = Black    L = Blue    R = Red  
BR = Brown    LG = Light Green    V = Violet  
G = Green    O = Orange    W = White  
GR = Gray    P = Pink    Y = Yellow

The first letter indicates the basic wire color and the second letter indicates the color of the stripe.

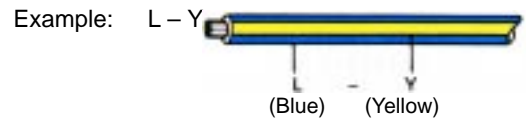

- (K) : Indicates a wiring Splice Point (Codes are "E" for the Engine Room, "I" for the Instrument Panel, and "B" for the Body).

Example:

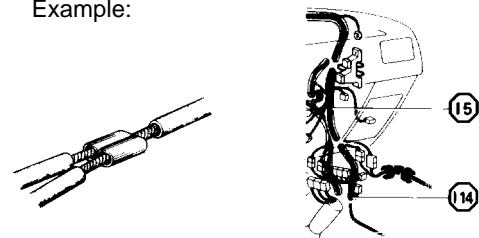

The Location of Splice Point I 5 is indicated by the shaded section.

- (L) : Page No.
- (M) : Indicates a shielded cable.

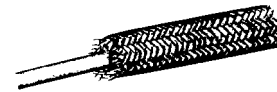

- (N) : Indicates a ground point.  
The first letter of the code for each ground point(s) indicates the component's location, e.g., "E" for the Engine Compartment, "I" for the Instrument Panel and Surrounding area, and "B" for the Body and Surrounding area.

- (O) : Indicates the pin number of the connector.  
The numbering system is different for female and male connectors.

Example:    Numbered in order from upper left to lower right    Numbered in order from upper right to lower left



- (P) : When 2 parts both use one connector in common, the parts connector name used in the wire routing section is shown in square brackets [    ].

# HOW TO USE THIS MANUAL



## SYSTEM OUTLINE

WITH THE IGNITION SW TURNED ON, THE CURRENT FLOWS TO **TERMINAL 3** OF THE POWER WINDOW MASTER SW, **TERMINAL 2** OF THE POWER WINDOW CONTROL RELAY AND **TERMINAL 8** OF THE POWER WINDOW SW THROUGH THE DOOR FUSE.

### 1. DRIVER'S WINDOW "MANUAL UP" OPERATION BY MASTER SW

HOLDING MANUAL SW (DRIVER'S) ON "UP" POSITION LOCATED IN POWER WINDOW MASTER SW, THE CURRENT FLOWS TO **TERMINAL 5** OF THE POWER WINDOW CONTROL RELAY THROUGH **TERMINAL 3** OF THE MASTER SW → **TERMINAL 2** TO OPERATE A POWER WINDOW CONTROL RELAY. THUS THE CURRENT INSIDE THE RELAY FLOWS FROM **TERMINAL 2** OF THE RELAY → **TERMINAL 1** → **TERMINAL 2** OF THE POWER WINDOW MOTOR → **TERMINAL 1** → **TERMINAL 4** OF THE RELAY → **TERMINAL 3** → TO GROUND. THE MOTOR TURNS TO ASCENT THE WINDOW. RELEASING THIS SW, THE ROTATION OF MOTOR IS STOPPED AND THE WINDOWS CAN STOP AT WILL POINT.

(FOR THE "MANUAL DOWN" OPERATION, CURRENT FLOWS IN THE REVERSE DIRECTION BECAUSE THE TERMINALS WHERE IT FLOWS ARE CHANGED).

### 2. DRIVER'S WINDOW "AUTO DOWN" OPERATION BY MASTER SW

ONCE THE "AUTO DOWN" BUTTON OF THE MASTER SW IS PUSHED, THE CURRENT FLOWS **TERMINAL 9** OF THE POWER WINDOW CONTROL RELAY THROUGH **TERMINAL 3** OF THE MASTER SW → **TERMINALS 8 AND 9** TO OPERATE THE RELAY. THUS THE CURRENT INSIDE THE POWER WINDOW CONTROL RELAY FLOWS FROM **TERMINAL 2** OF THE RELAY → **TERMINAL 4** → **TERMINAL 1** OF THE POWER WINDOW MOTOR → **TERMINAL 2** → **TERMINAL 1** OF THE RELAY → **TERMINAL 3** → TO GROUND. THE MOTOR CONTINUES THE ROTATION ENABLING TO DESCEND THE WINDOW.

THE WINDOW DESCENDS TO THE END POSITION. THE CURRENT WILL BE CUT OFF TO RELEASE THE AUTO DOWN FUNCTION BASED ON THE INCREASING CURRENT BETWEEN **TERMINAL 2** OF THE RELAY AND **TERMINAL 1** IN RELAY.

### 3. DRIVER'S WINDOW AUTO DOWN RELEASE OPERATION BY MASTER SW

HOLDING THE MANUAL SW (DRIVER'S) ON "UP" POSITION IN OPERATING AUTO DOWN. THE CURRENT FROM **TERMINAL 3** OF THE MASTER SW PASSING **TERMINAL 2** FLOWS **TERMINAL 5** OF THE RELAY AND RELEASES THE AUTO DOWN FUNCTION IN THE POWER WINDOW CONTROL RELAY. RELEASING THE HAND FROM SW, WINDOW STOPS AND CONTINUING ON TOUCHING SW, THE FUNCTION SWITCHES TO MANUAL UP OPERATION.

### 4. PASSENGER'S WINDOW UP OPERATION (MASTER SW) AND WINDOW LOCK SW OPERATION

HOLDING PASSENGER'S WINDOW SW (MASTER SW) ON "UP", THE CURRENT FLOWS FROM **TERMINAL 3** OF THE MASTER SW PASSING **TERMINAL 6** TO **TERMINAL 3** OF THE POWER WINDOW SW (PASSENGER'S) → **TERMINAL 4** → **TERMINAL 2** OF THE MOTOR → **TERMINAL 1** → **TERMINAL 9** OF THE POWER WINDOW SW → **TERMINAL 7** → **TERMINAL 1** OF THE MASTER SW → **TERMINAL 4** TO GROUND. THE MOTOR RUNS TO ASCENT THE WINDOW. RELEASING THIS SW, THE ROTATION OF MOTOR IS STOPPED AND WINDOW CAN STOP AT WILL PLACE.

SWITCHING THE WINDOW LOCK SW IN "LOCK" POSITION, THE CIRCUIT IS OPENED AND STOPPED THE MOTOR ROTATION.

(FOR THE DOWN OPERATION, CURRENT FLOWS IN THE REVERSE DIRECTION BECAUSE THE TERMINALS WHERE IT FLOWS ARE CHANGED).



## SERVICE HINTS

### P 2 POWER WINDOW CONTROL RELAY

3-GROUND: ALWAYS CONTINUITY

2-GROUND: APPROX. 12 VOLTS WITH IGNITION SW AT ON POSITION

5-GROUND: APPROX. 12 VOLTS WITH IGNITION SW AT ON POSITION AND MASTER SW ON UP POSITION

8-GROUND: APPROX. 12 VOLTS WITH IGNITION SW AT ON POSITION AND MASTER SW ON AUTO DOWN POSITION

9-GROUND: APPROX. 12 VOLTS WITH IGNITION SW AT ON POSITION AND MASTER SW ON DOWN OR AUTO DOWN POSITION

### P 4 POWER WINDOW MASTER SW

4-GROUND: ALWAYS CONTINUITY

3-GROUND: APPROX. 12 VOLTS WITH IGNITION SW AT ON POSITION

### WINDOW LOCK SW

OPEN WITH THE WINDOW LOCK SW AT LOCK POSITION



## ○ : PARTS LOCATION

CODE	SEE PAGE	CODE	SEE PAGE	CODE	SEE PAGE
P 2	21	P 4	21	P 6	21
P 3	21	P 5	21		



## ○ : RELAY BLOCKS

CODE	SEE PAGE	RELAY BLOCK (RELAY BLOCK LOCATION)
1	16	R/B NO. 1 (INSTRUMENT PANEL LEFT SIDE)



## ○ : JUNCTION BLOCK AND WIRE HARNESS CONNECTOR

CODE	SEE PAGE	JUNCTION BLOCK AND WIRE HARNESS (CONNECTOR LOCATION)
3B	14	J/B NO. 3 AND COWL WIRE (INSTRUMENT PANEL LEFT SIDE)



## □ : CONNECTOR JOINING WIRE HARNESS AND WIRE HARNESS

CODE	SEE PAGE	JOINING WIRE HARNESS AND WIRE HARNESS (CONNECTOR LOCATION)
ID1	26	FRONT DOOR RH WIRE AND COWL WIRE (RIGHT KICK PANEL)
IH1	26	FRONT DOOR LH WIRE AND COWL WIRE (LEFT KICK PANEL)



## ▽ : GROUND POINTS

CODE	SEE PAGE	GROUND POINT LOCATION
IC	24	COWL LEFT



## ○ : SPLICE POINTS

CODE	SEE PAGE	WIRE HARNESS WITH SPLICE POINTS
I 5	24	COWL WIRE

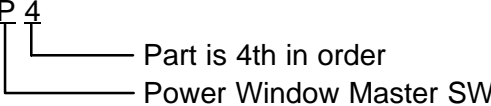
- Ⓚ : Explains the system outline.
- Ⓡ : Indicates values or explains the function for reference during troubleshooting.
- Ⓢ : Indicates the reference page showing the position on the vehicle of the parts in the system circuit.  
 Example: Part “P4” (Power Window Master SW) is on page 21 of the manual.  
 \* The letter in the code is from the first letter of the part, and the number indicates its order in parts starting with the letter.  
 Example: P 4  

- Ⓣ : Indicates the reference page showing the position on the vehicle of Relay Block Connectors in the system circuit.  
 Example: Connector “1” is described on page 16 of this manual and is installed on the left side of the instrument panel.
- Ⓤ : Indicates the reference page showing the position on the vehicle of J/B and Wire Harness in the system circuit.  
 Example: Connector “3B” connects the Cowl Wire and J/B No. 3. It is described on page 14 of this manual, and is installed on the instrument panel left side.
- Ⓥ : Indicates the reference page describing the wiring harness and wiring harness connector (the female wiring harness is shown first, followed by the male wiring harness).  
 Example: Connector “ID1” connects the front door RH wire (female) and cowl wire (male). It is described on page 26 of this manual, and is installed on the right side kick panel.
- Ⓦ : Indicates the reference page showing the position of the ground points on the vehicle.  
 Example: Ground point “IC” is described on page 24 of this manual and is installed on the cowl left side.
- Ⓧ : Indicates the reference page showing the position of the splice points on the vehicle.  
 Example: Splice point “I 5” is on the Cowl Wire Harness and is described on page 24 of this manual.

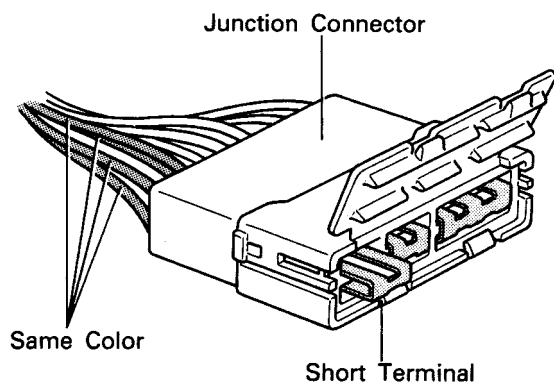
## HINT



Junction connector (code: J1, J2, J3, J4, J5, J6, J7, J8, J9, J10, J11, J12, J13) in this manual include a short terminal which is connected to a number of wire harnesses. Always perform inspection with the short terminal installed. (When installing the wire harnesses, the harnesses can be connected to any position within the short terminal grouping. Accordingly, in other vehicles, the same position in the short terminal may be connected to a wire harness from a different part.)

Wire harness share the same short terminal grouping have the same color.

# HOW TO USE THIS MANUAL

The "Current Flow Chart" section, describes which parts each power source (fuses, fusible links, and circuit breakers) transmits current to. In the Power Source circuit diagram, the conditions when battery power is supplied to each system are explained. Since all System Circuit diagrams start from the power source, the power source system must be fully understood.

## H POWER SOURCE (Current Flow Chart)

The chart below shows the route by which current flows from the battery to each electrical source (Fusible Link, Circuit Breaker, Fuse, etc.) and other parts.

The next page and following pages show the parts to which each electrical source outputs current.

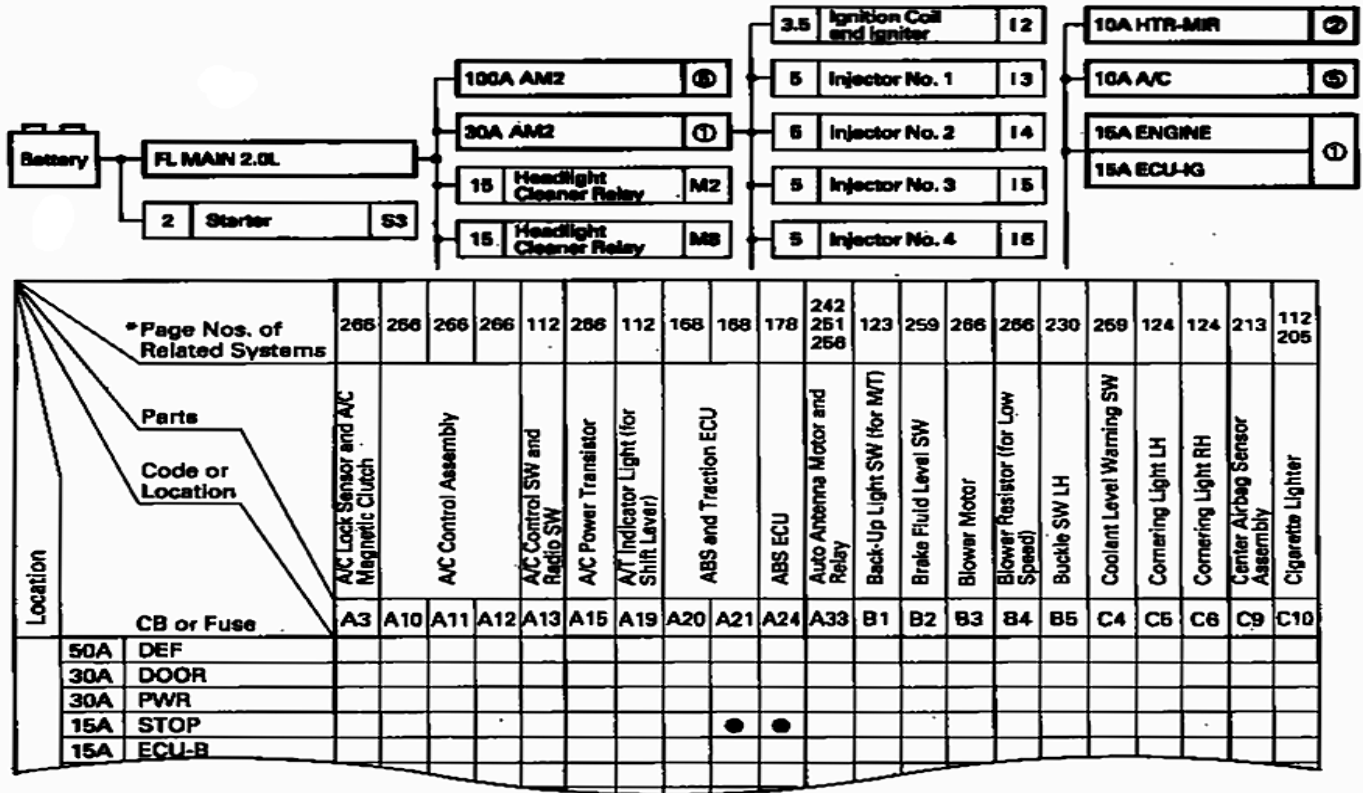

## POWER SOURCE

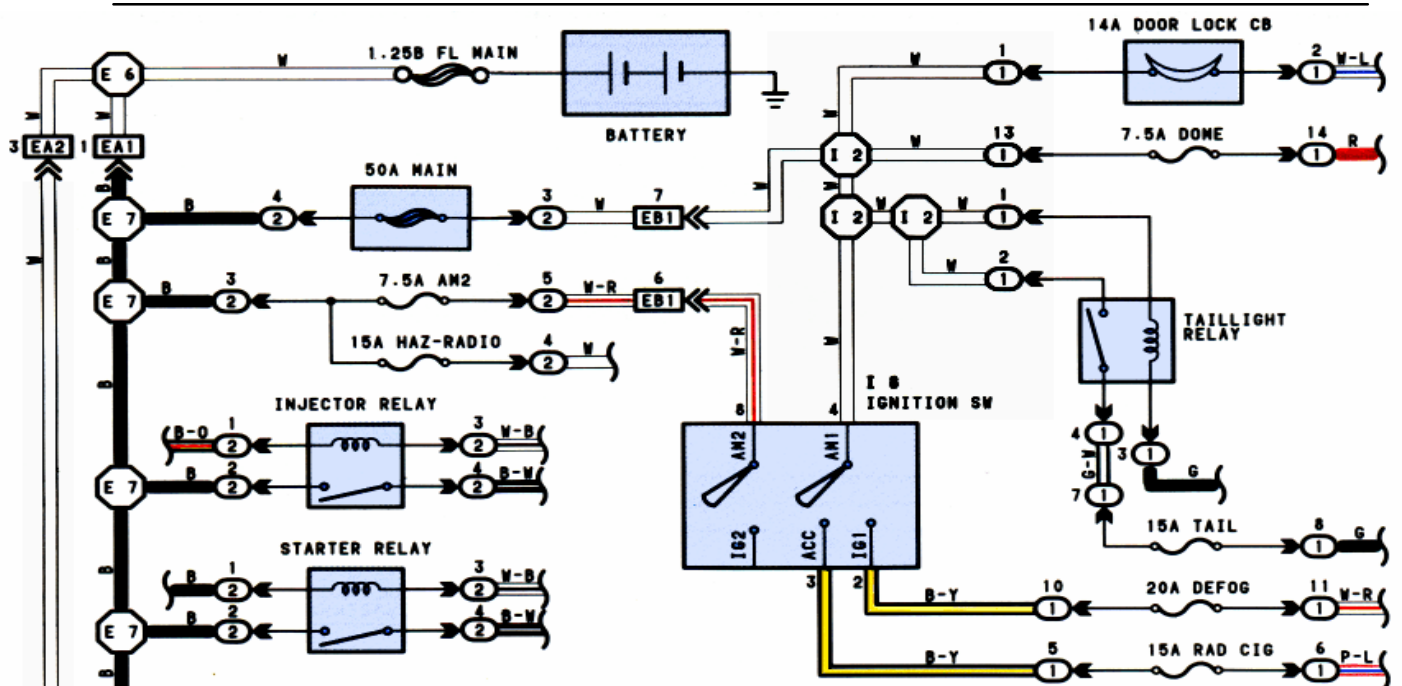

The system shown here is an EXAMPLE ONLY. It is different to the actual circuit shown in the SYSTEM CIRCUITS SECTION.



The ground points circuit diagram shows the connections from all major parts to the respective ground points. When troubleshooting a faulty ground point, checking the system circuits which use a common ground may help you identify the problem ground quickly. The relationship between ground points (EA, IB, and IC shown below) can also be checked this way.

## J GROUND POINT

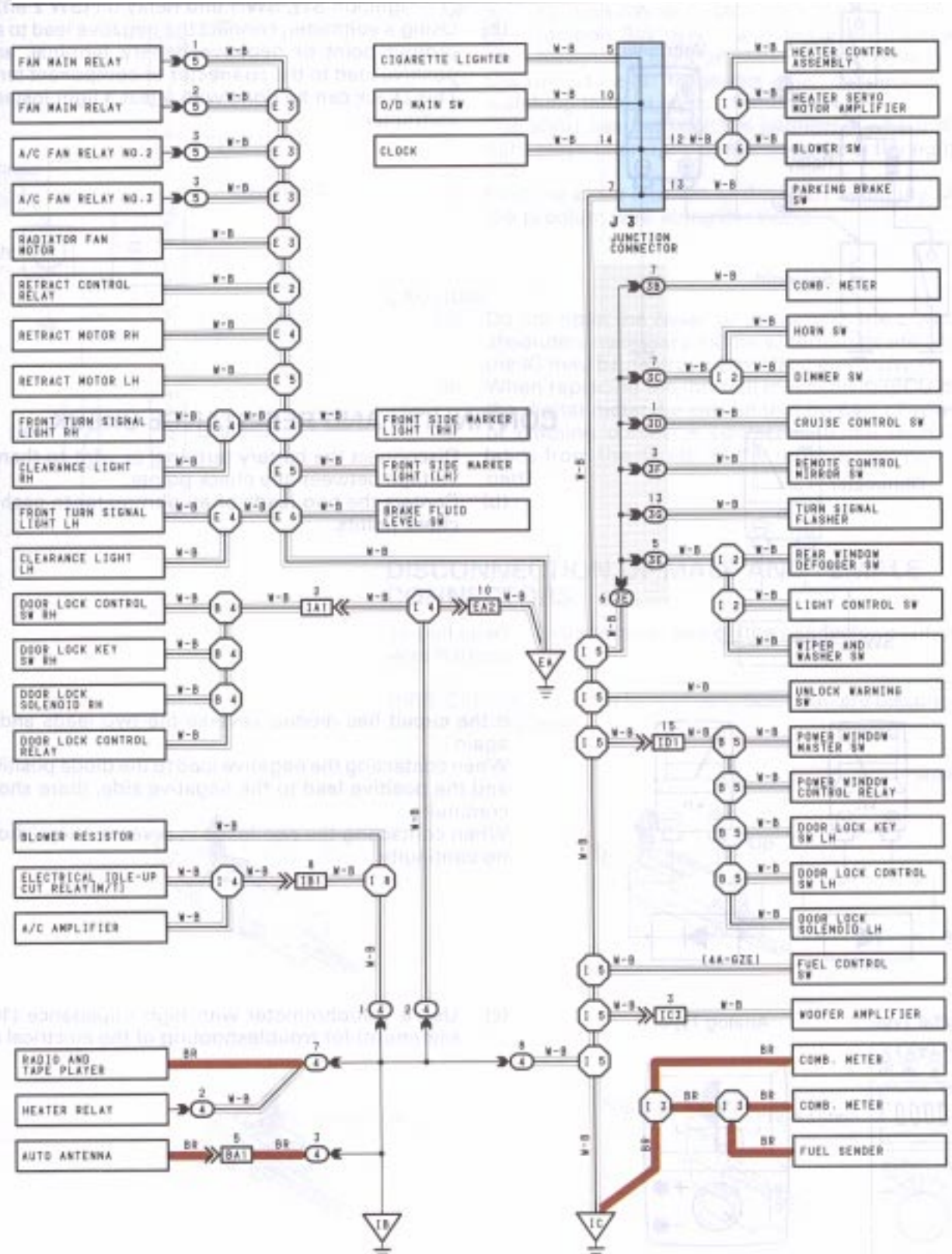

\* The system shown here is an EXAMPLE ONLY. It is different to the actual circuit shown in the SYSTEM CIRCUITS SECTION.

# TROUBLESHOOTING

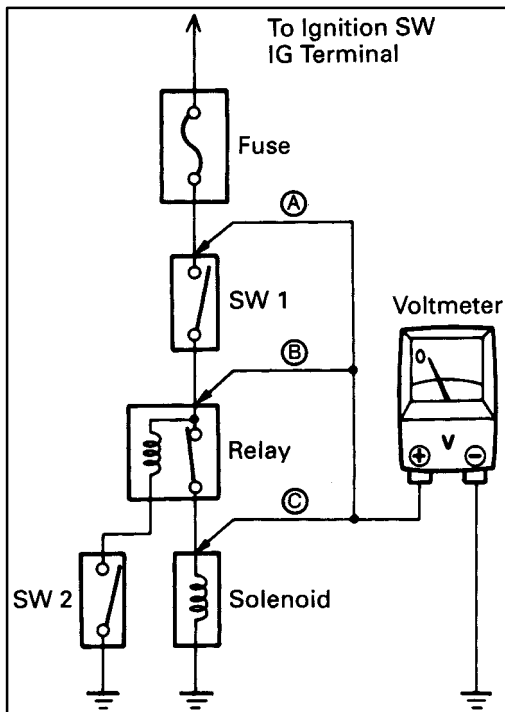

## VOLTAGE CHECK

- (a) Establish conditions in which voltage is present at the check point.

Example:

- Ⓐ – Ignition SW on
- Ⓑ – Ignition SW and SW 1 on
- Ⓒ – Ignition SW, SW 1 and Relay on (SW 2 off)

- (b) Using a voltmeter, connect the negative lead to a good ground point or negative battery terminal, and the positive lead to the connector or component terminal. This check can be done with a test light instead of a voltmeter.

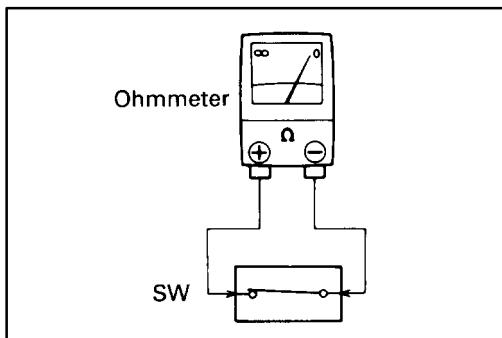

## CONTINUITY AND RESISTANCE CHECK

- (a) Disconnect the battery terminal or wire so there is no voltage between the check points.
- (b) Contact the two leads of an ohmmeter to each of the check points.

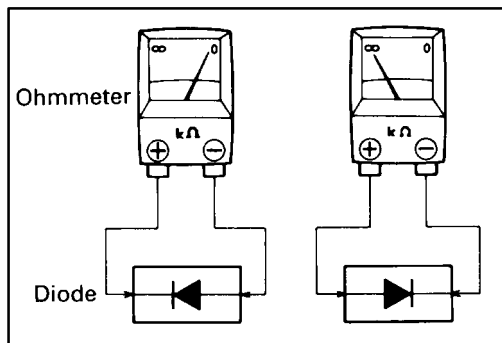

If the circuit has diodes, reverse the two leads and check again.

When contacting the negative lead to the diode positive side and the positive lead to the negative side, there should be continuity.

When contacting the two leads in reverse, there should be no continuity.

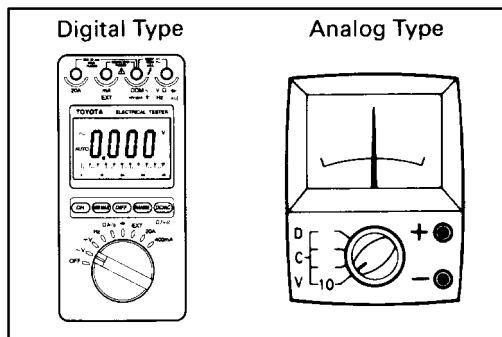

- (c) Use the volt/ohmmeter with high impedance (10 kΩ/V minimum) for troubleshooting of the electrical circuit.

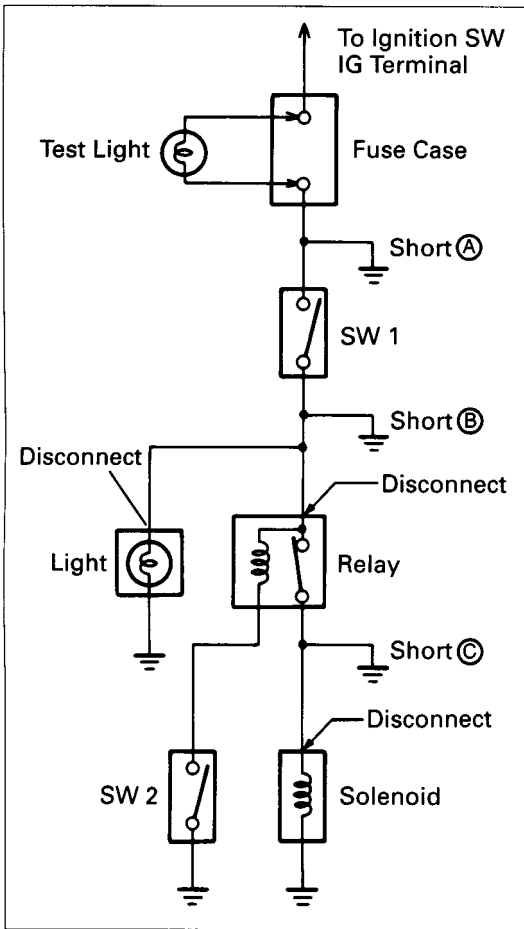

## FINDING A SHORT CIRCUIT

- (a) Remove the blown fuse and disconnect all loads of the fuse.
- (b) Connect a test light in place of the fuse.
- (c) Establish conditions in which the test light comes on.

Example:

- Ⓐ – Ignition SW on
  - Ⓑ – Ignition SW and SW 1 on
  - Ⓒ – Ignition SW, SW 1 and Relay on (Connect the Relay) and SW 2 off (or Disconnect SW 2)
- (d) Disconnect and reconnect the connectors while watching the test light.

The short lies between the connector where the test light stays lit and the connector where the light goes out.

- (e) Find the exact location of the short by lightly shaking the problem wire along the body.

## CAUTION:

- (a) Do not open the cover or the case of the ECU unless absolutely necessary. (If the IC terminals are touched, the IC may be destroyed by static electricity.)
- (b) When replacing the internal mechanism (ECU part) of the digital meter, be careful that no part of your body or clothing comes in contact with the terminals of leads from the IC, etc. of the replacement part (spare part).

## DISCONNECTION OF MALE AND FEMALE CONNECTORS

To pull apart the connectors, pull on the connector itself, not the wire harness.

HINT: Check to see what kind of connector you are disconnecting before pulling apart.

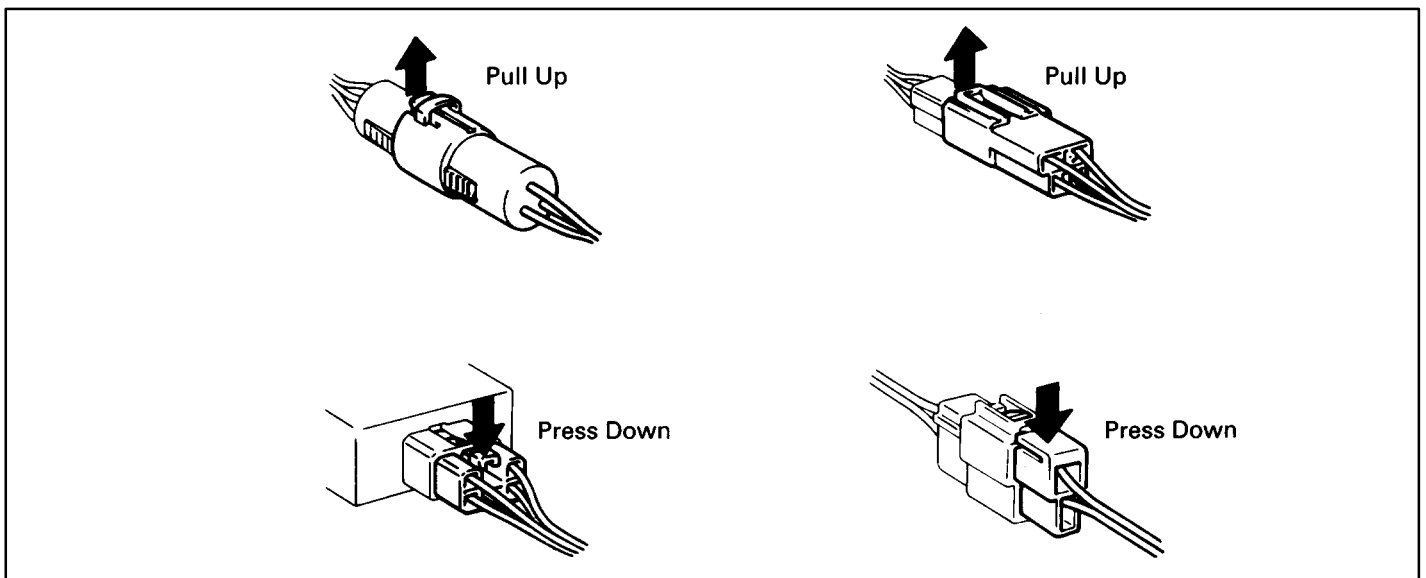

# TROUBLESHOOTING

Reference:

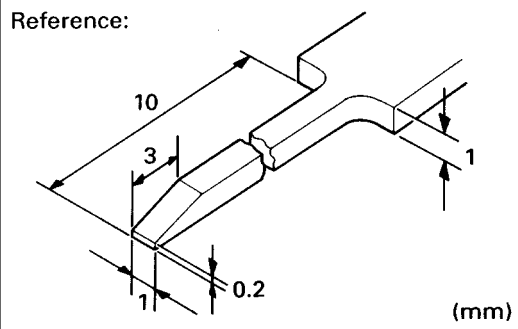

## HOW TO REPLACE TERMINAL

### (with terminal retainer or secondary locking device)

1. PREPARE THE SPECIAL TOOL  
HINT: To remove the terminal from the connector, please construct and use the special tool or like object shown on the left.
2. DISCONNECT CONNECTOR
3. DISENGAGE THE SECONDARY LOCKING DEVICE OR TERMINAL RETAINER
  - (a) Locking device must be disengaged before the terminal locking clip can be released and the terminal removed from the connector.
  - (b) Use a special tool or the terminal pick to unlock the secondary locking device or terminal retainer.

#### NOTICE:

**Do not remove the terminal retainer from connector body.**

Example:  
(Case 1)

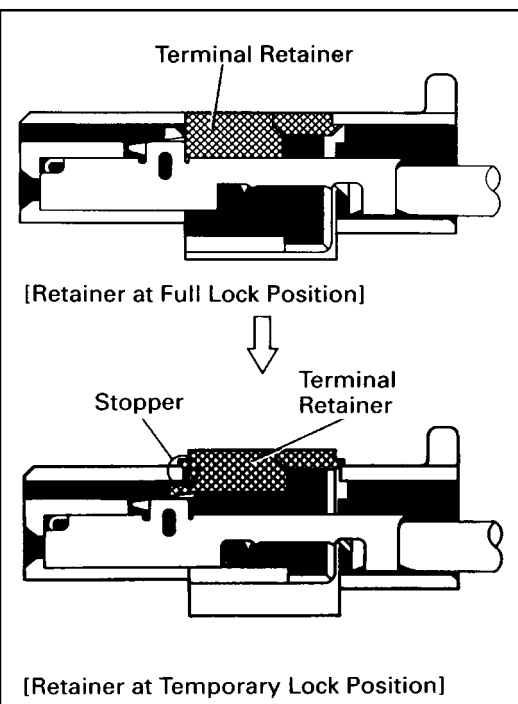
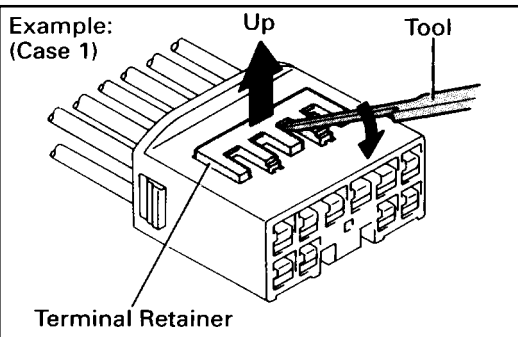

- Ⓐ For Non-Waterproof Type Connector

HINT: The needle insertion position varies according to the connector's shape (number of terminals etc.), so check the position before inserting it.

"Case 1"

Raise the terminal retainer up to the temporary lock position.

"Case 2"

Open the secondary locking device.

Example:  
(Case 2)

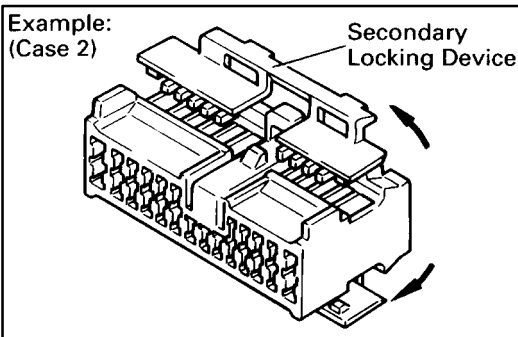

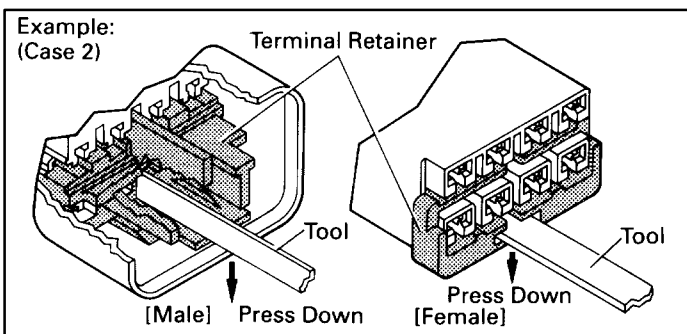
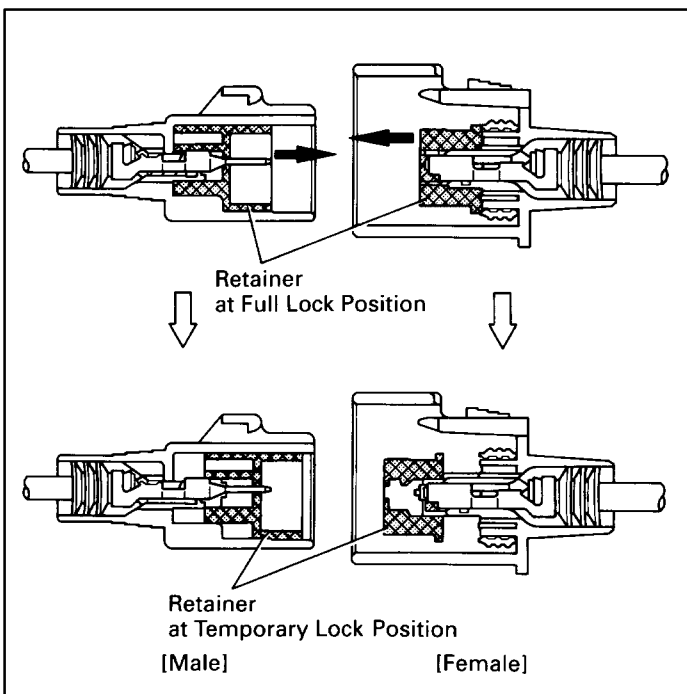
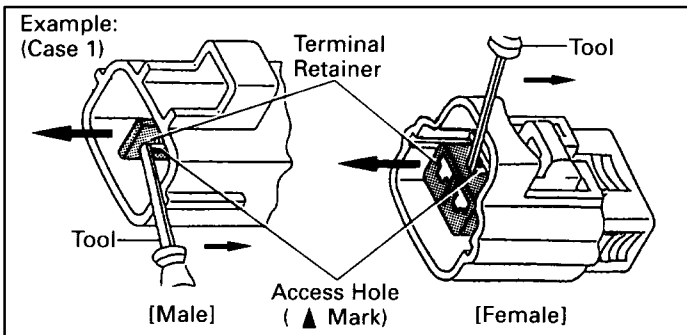
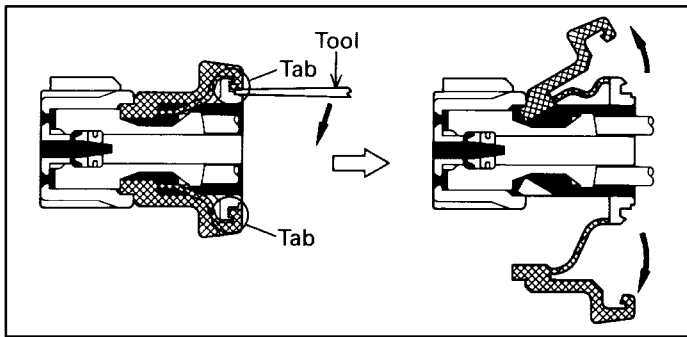

- ② For Waterproof Type Connector
- HINT: Terminal retainer color is different according to connector body.
- Example:

Terminal Retainer:	Connector Body
Black or White	: Gray
Black or White	: Dark Gray
Gray or White	: Black

“Case 1”

Type where terminal retainer is pulled up to the temporary lock position (Pull Type). Insert the special tool into the terminal retainer access hole (▲ Mark) and pull the terminal retainer up to the temporary lock position.

HINT: The needle insertion position varies according to the connector's shape (number of terminals, etc.), so check the position before inserting it.

“Case 2”

Type which cannot be pulled as far as Power Lock insert the tool straight into the access hole of terminal retainer as shown.

# TROUBLESHOOTING

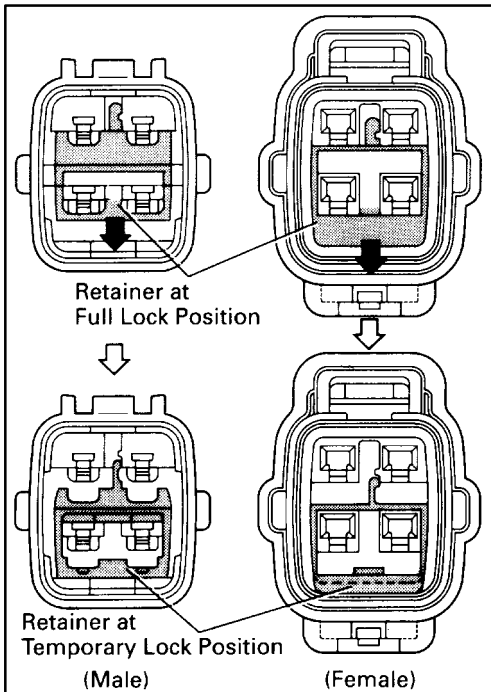

Push the terminal retainer down to the temporary lock position.

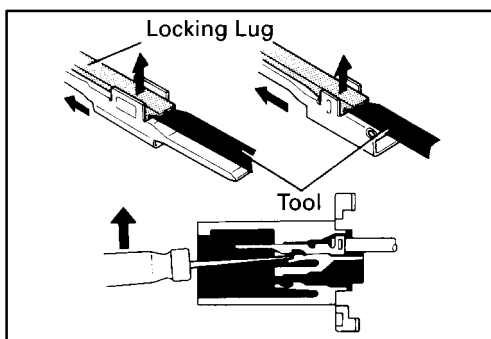

(c) Release the locking lug from terminal and pull the terminal out from rear.

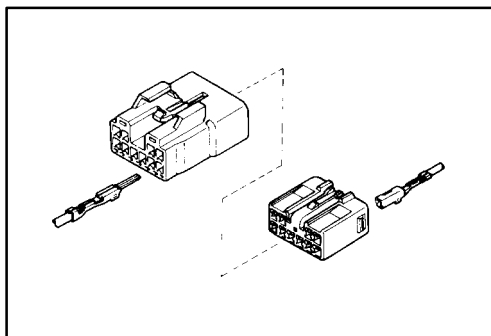

## 4. INSTALL TERMINAL TO CONNECTOR

(a) Insert the terminal.

HINT:

1. Make sure the terminal is positioned correctly.
2. Insert the terminal until the locking lug locks firmly.
3. Insert the terminal with terminal retainer in the temporary lock position.

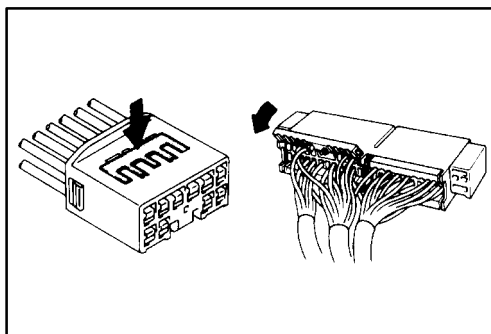

(b) Push the secondary locking device or terminal retainer into the full lock position.

## 5. CONNECT CONNECTOR

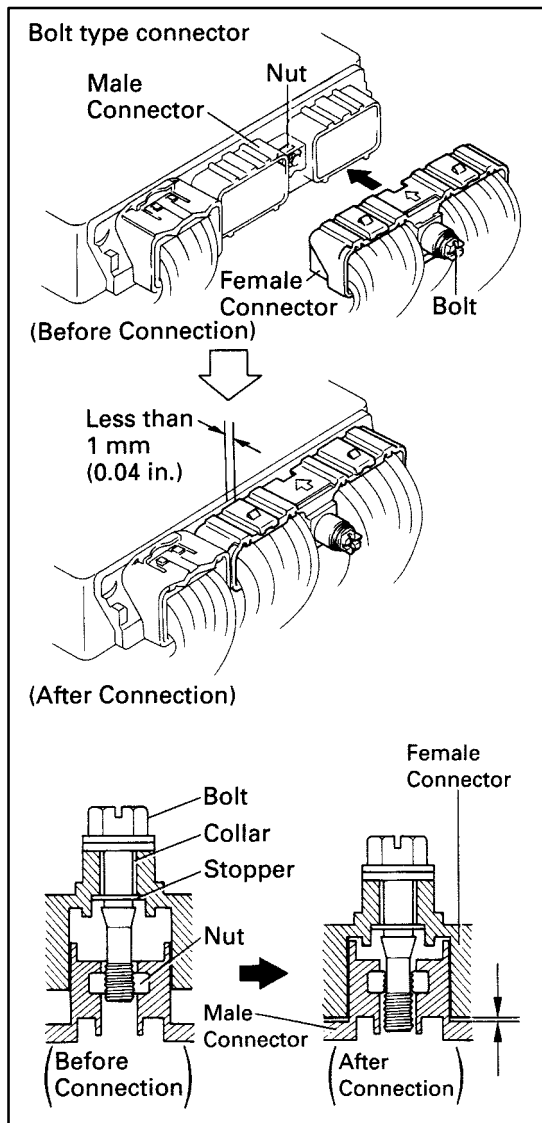

## DISCONNECTION AND CONNECTION OF BOLT TYPE CONNECTORS

For engine control module (engine and electronically controlled transmission ECU) in this vehicle, connectors are used which require a bolt built into the connector to be screwed down to securely connect the connector.

### 1. Disconnect the connector

After completely loosening the bolt, the two parts of the connector can be separated.

#### NOTICE:

Do not pull the wire harness when disconnecting the connector.

### 2. Connect the connector

#### NOTICE:

Before connecting the connector, always check that the terminals are not bent or damaged.

(a) Match the guide section of the male connector correctly with the female connector, then press them together.

(b) Tighten the bolt.

Make sure the connectors are completely connected, by tightening the bolt until there is a clearance of less than 1 mm (0.04 in.) between the bottom of male connector and the end of female connector.

## ABBREVIATIONS











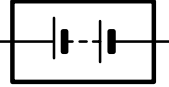





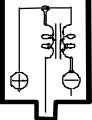

The following abbreviations are used in this manual.

ABS	= Anti-Lock Brake System
A/C	= Air Conditioning
A/T	= Automatic Transmission
COMB.	= Combination
ECU	= Electronic Control Unit
EFI	= Electronic Fuel Injection
EGR	= Exhaust Gas Recirculation
EVAP	= Evaporative Emission
ISC	= Idle Speed Control
J/B	= Junction Block
LH	= Left-Hand
O/D	= Overdrive



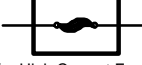
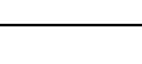



PPS	= Progressive Power Steering
R/B	= Relay Block
RH	= Right-Hand
SRS	= Supplemental Restraint System
SW	= Switch
TDCL	= Total Diagnostic Communication Link
TEMP.	= Temperature
TRAC	= Traction Control
VSV	= Vacuum Switching Valve
w/	= With
w/o	= Without

\* The titles given inside the components are the names of the terminals (terminal codes) and are not treated as being abbreviations.

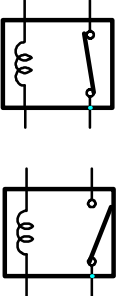
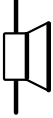
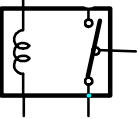
# GLOSSARY OF TERMS AND SYMBOLS

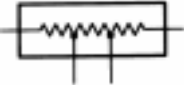
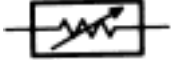
 <p><b>BATTERY</b> Stores chemical energy and converts it into electrical energy. Provides DC current for the auto's various electrical circuits.</p>	 <p><b>HEADLIGHTS</b> <b>1. SINGLE FILAMENT</b> Current flow causes a headlight filament to heat up and emit light. A headlight may have either a single (1) filament or a double (2) filament.</p>
 <p><b>CAPACITOR (Condenser)</b> A small holding unit for temporary storage of electrical voltage.</p>	 <p><b>2. DOUBLE FILAMENT</b></p>
 <p><b>CIGARETTE LIGHTER</b> An electric resistance heating element.</p>	 <p><b>HORN</b> An electric device which sounds a loud audible signal.</p>
 <p><b>CIRCUIT BREAKER</b> Basically a reusable fuse, a circuit breaker will heat and open if too much current flows through it. Some units automatically reset when cool, others must be manually reset.</p>	 <p><b>IGNITION COIL</b> Convert low-voltage DC current into high-voltage ignition current for firing the spark plugs.</p>
 <p><b>DIODE</b> A semiconductor which allows current flow in only one direction.</p>	 <p><b>LIGHT</b> Current flow through a filament causes the filament to heat up and emit light.</p>
 <p><b>DIODE, ZENER</b> A diode which allows current flow in one direction but blocks reverse flow only up to a specific voltage. Above that potential, it passes the excess voltage. This acts as a simple voltage regulator.</p>	 <p><b>LED (LIGHT EMITTING DIODE)</b> Upon current flow, these diodes emit light without producing the heat of a comparable light.</p>
 <p><b>DISTRIBUTOR, IIA</b> Channels high-voltage current from the ignition coil to the individual spark plugs.</p>	 <p><b>METER, ANALOG</b> Current flow activates a magnetic coil which causes a needle to move, thereby providing a relative display against a background calibration.</p>
 <p><b>FUSE</b> A thin metal strip which burns through when too much current flows through it, thereby stopping current flow and protecting a circuit from damage.</p>  <p><b>FUSIBLE LINK</b> A heavy-gauge wire placed in high amperage circuits which burns through on overloads, thereby protecting the circuit. The numbers indicate the cross-section surface area of the wires.</p>  <p>(for Medium Current Fuse)</p>  <p>(for High Current Fuse or Fusible Link.)</p>	 <p><b>METER, DIGITAL</b> Current flow activates one or many LED's, LCD's, or fluorescent displays, which provide a relative or digital display.</p>  <p><b>MOTOR</b> A power unit which converts electrical energy into mechanical energy, especially rotary motion.</p>
 <p><b>GROUND</b> The point at which wiring attaches to the Body, thereby providing a return path for an electrical circuit; without a ground, current cannot flow.</p>	

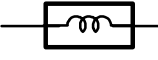

 <p><b>RELAY</b> 1. <b>NORMALLY CLOSED</b> 2. <b>NORMALLY OPEN</b></p>	<p>Basically, an electrically operated switch which may be normally closed (1) or open (2). Current flow through a small coil creates a magnetic field which either opens or closes an attached switch.</p>	 <p><b>SPEAKER</b> An electromechanical device which creates sound waves from current flow.</p>
 <p><b>RELAY, DOUBLE THROW</b> A relay which passes current through one set of contacts or the other.</p>	<p><b>SWITCH, MANUAL</b> 1. <b>NORMALLY OPEN</b> 2. <b>NORMALLY CLOSED</b></p> <p>Opens and closes circuits, thereby stopping (1) or allowing (2) current flow.</p>	
 <p><b>RESISTOR</b> An electrical component with a fixed resistance, placed in a circuit to reduce voltage to a specific value.</p>	<p><b>SWITCH, DOUBLE THROW</b> A switch which continuously passes current through one set of contacts or the other.</p>	
 <p><b>RESISTOR, TAPPED</b> A resistor which supplies two or more different non adjustable resistance values.</p>	<p><b>SWITCH, IGNITION</b> A key operated switch with several positions which allows various circuits, particularly the primary ignition circuit, to become operational.</p>	
 <p><b>RESISTOR, VARIABLE OR RHEOSTAT</b> A controllable resistor with a variable rate of resistance. Also called a potentiometer or rheostat.</p>	<p><b>SWITCH, WIPER PARK</b> Automatically returns wipers to the stop position when the wiper switch is turned off.</p>	
 <p><b>SENSOR (Thermistor)</b> A resistor which varies its resistance with temperature.</p>	<p><b>TRANSISTOR</b> A solidstate device typically used as an electronic relay; stops or passes current depending on the voltage applied at "base."</p>	
 <p><b>SENSOR, ANALOG SPEED</b> Uses magnetic impulses to open and close a switch to create a signal for activation of other components.</p>	<p><b>WIRES</b> (1) <b>NOT CONNECTED</b> (2) <b>SPLICED</b></p> <p>Wires are always drawn as straight lines on wiring diagrams. Crossed wires (1) without a black dot at the junction are not joined; crossed wires (2) with a black dot or octagonal (O) mark at the junction are spliced (joined) connections.</p>	
 <p><b>SHORT PIN</b> Used to provide an unbroken connection within a junction block.</p>		
 <p><b>SOLENOID</b> An electromagnetic coil which forms a magnetic field when current flows, to move a plunger, etc.</p>		

# RELAY LOCATIONS

## [Engine Compartment]

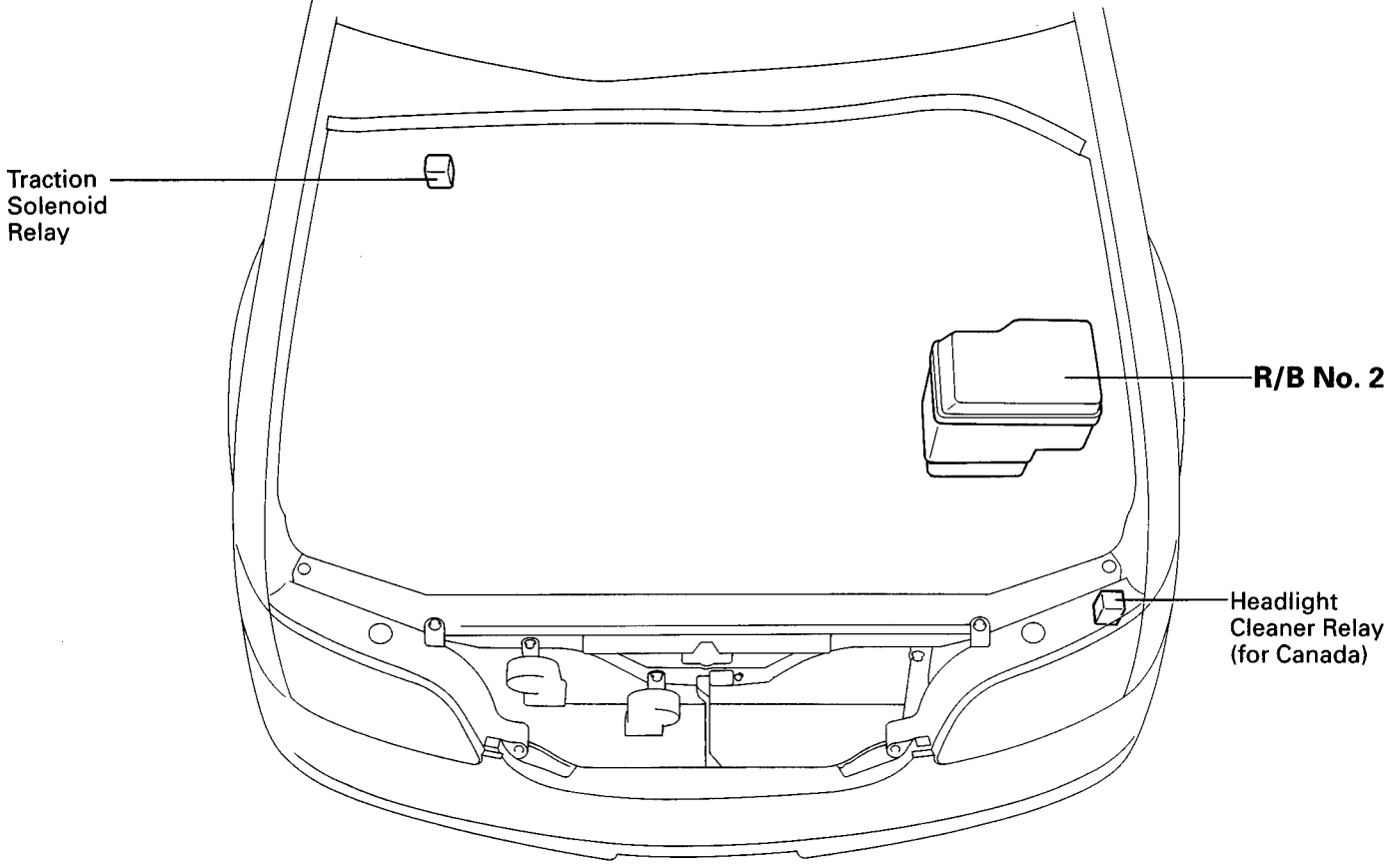

## [Instrument Panel]

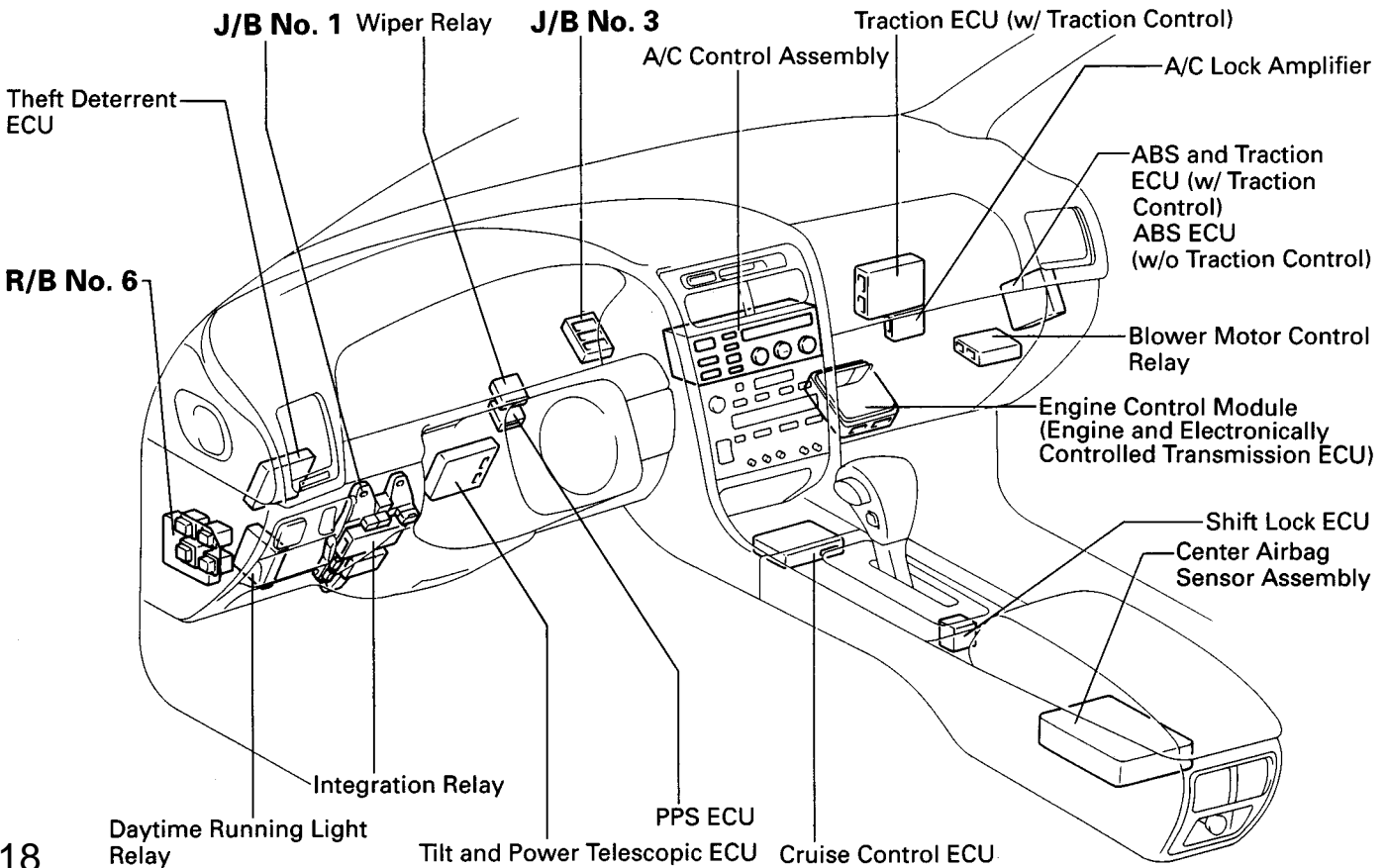

[Body]

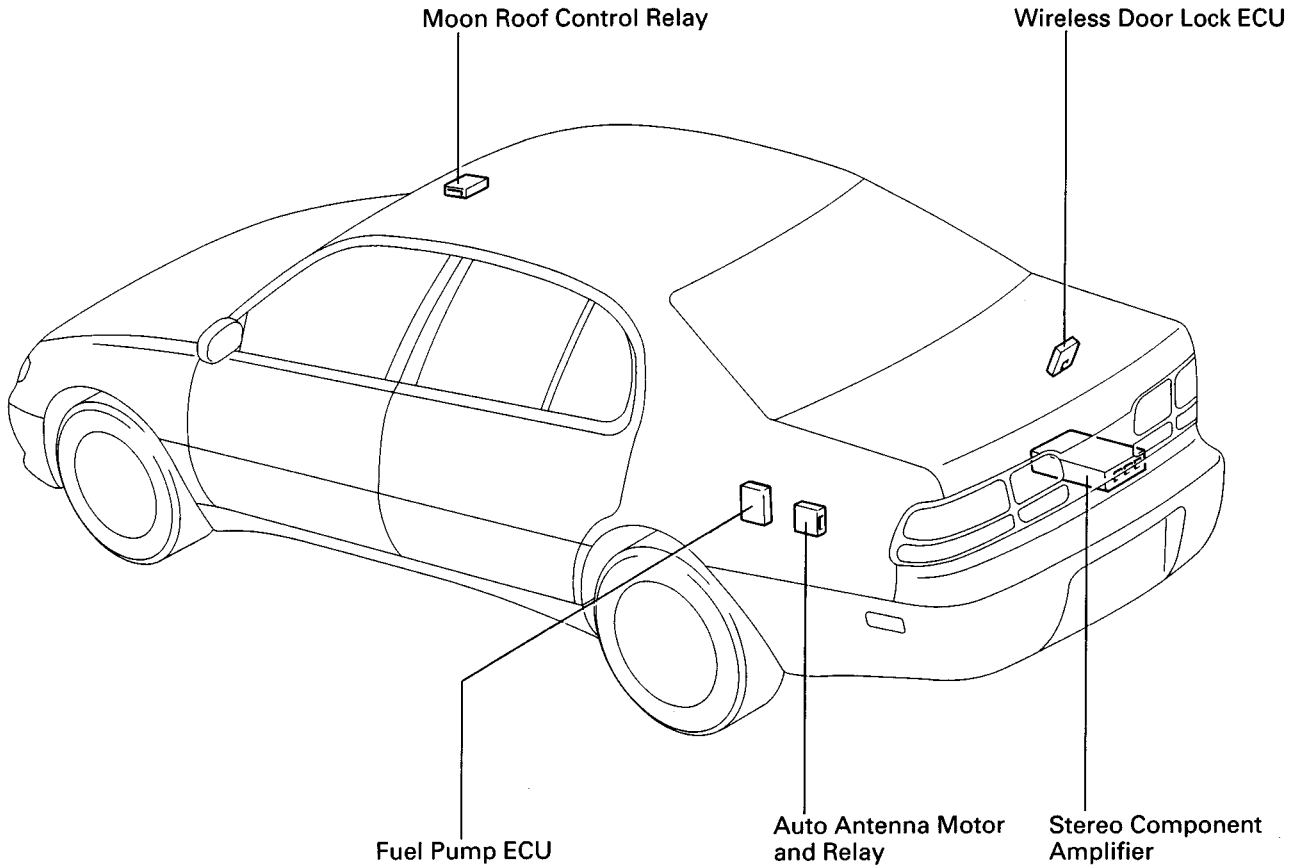

② : R/B No. 2 Engine Compartment Left (See Page 18)

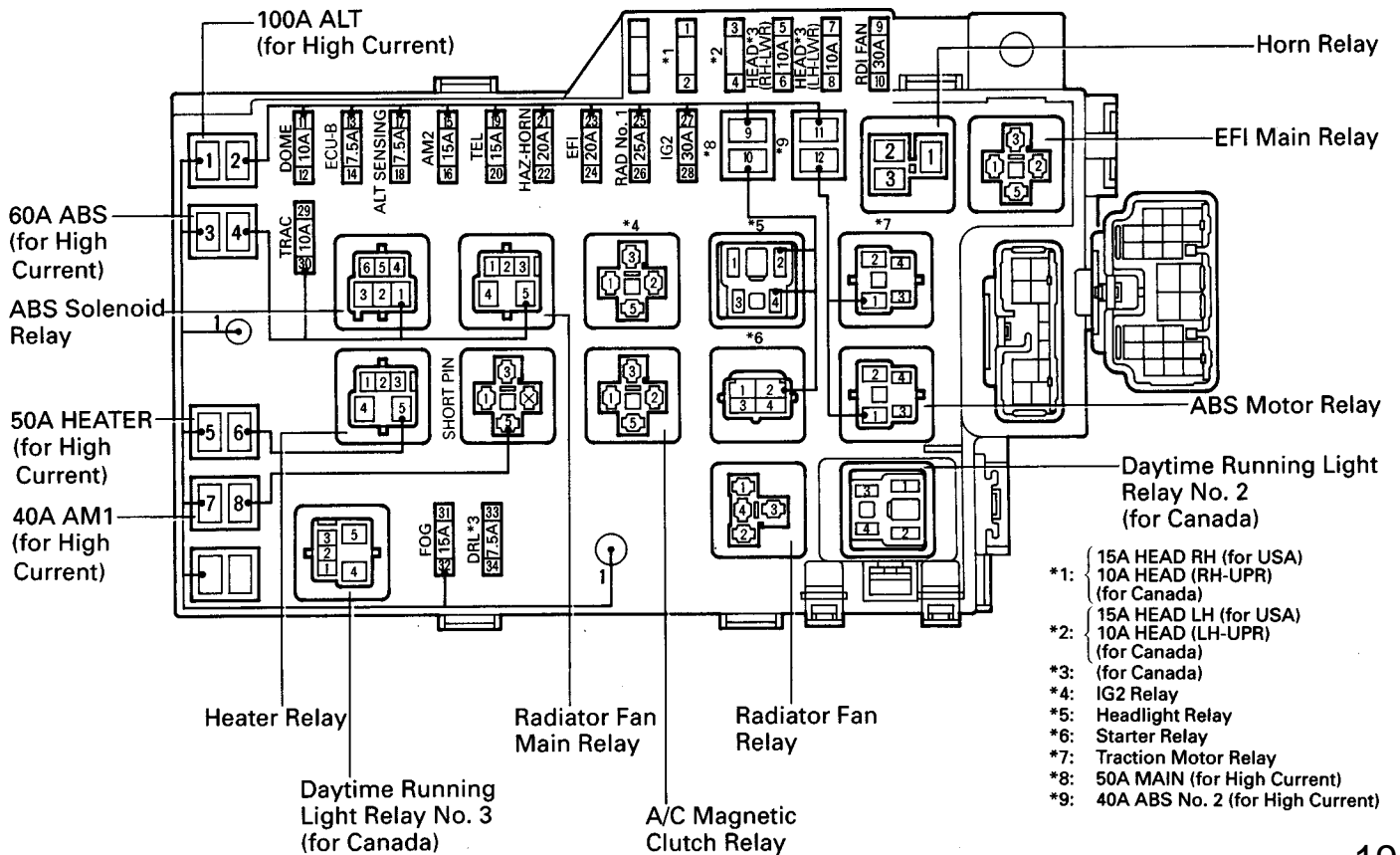

# RELAY LOCATIONS

○ : J/B No. 1      Left Kick Panel (See Page 18)

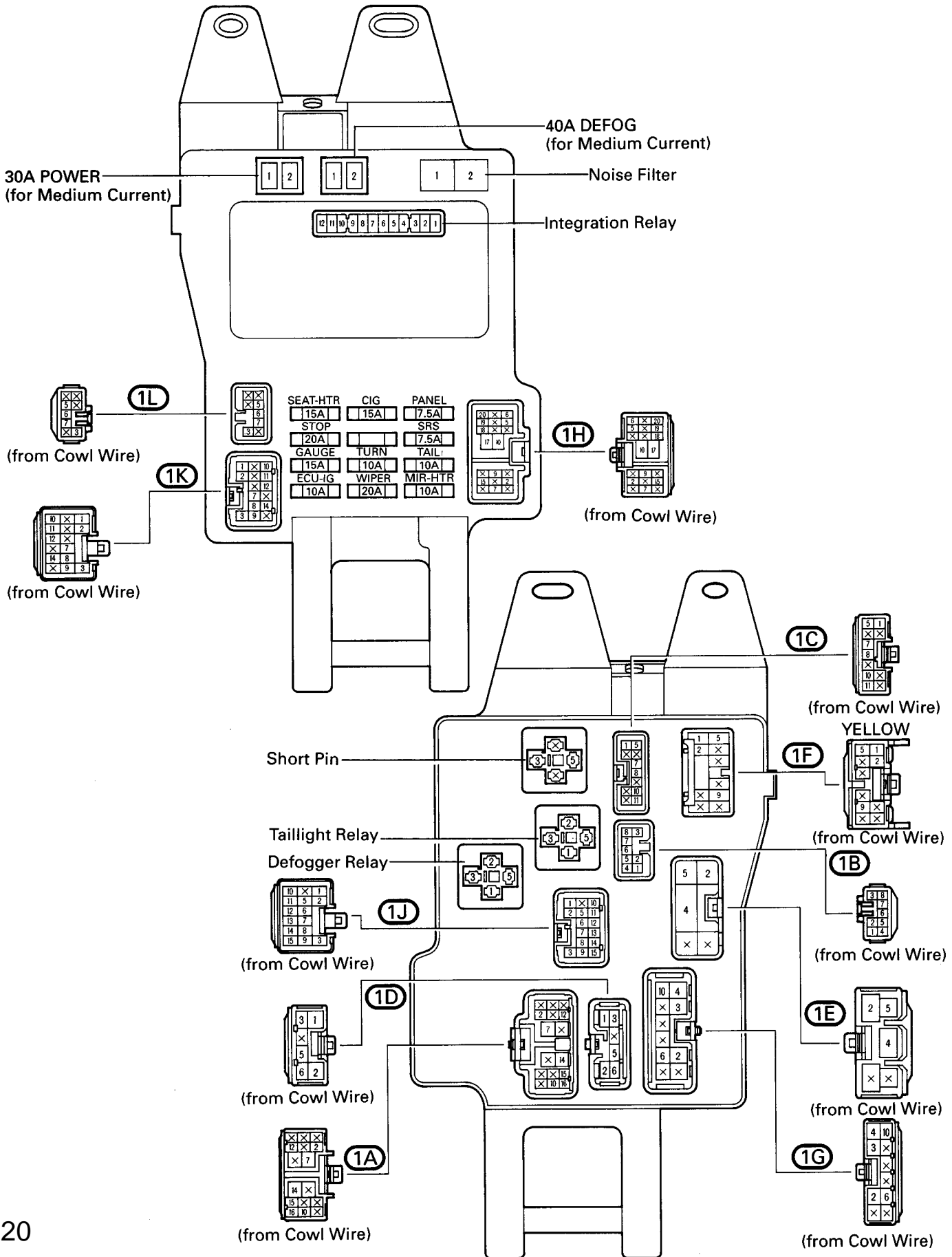

[J/B No. 1 Inner Circuit]

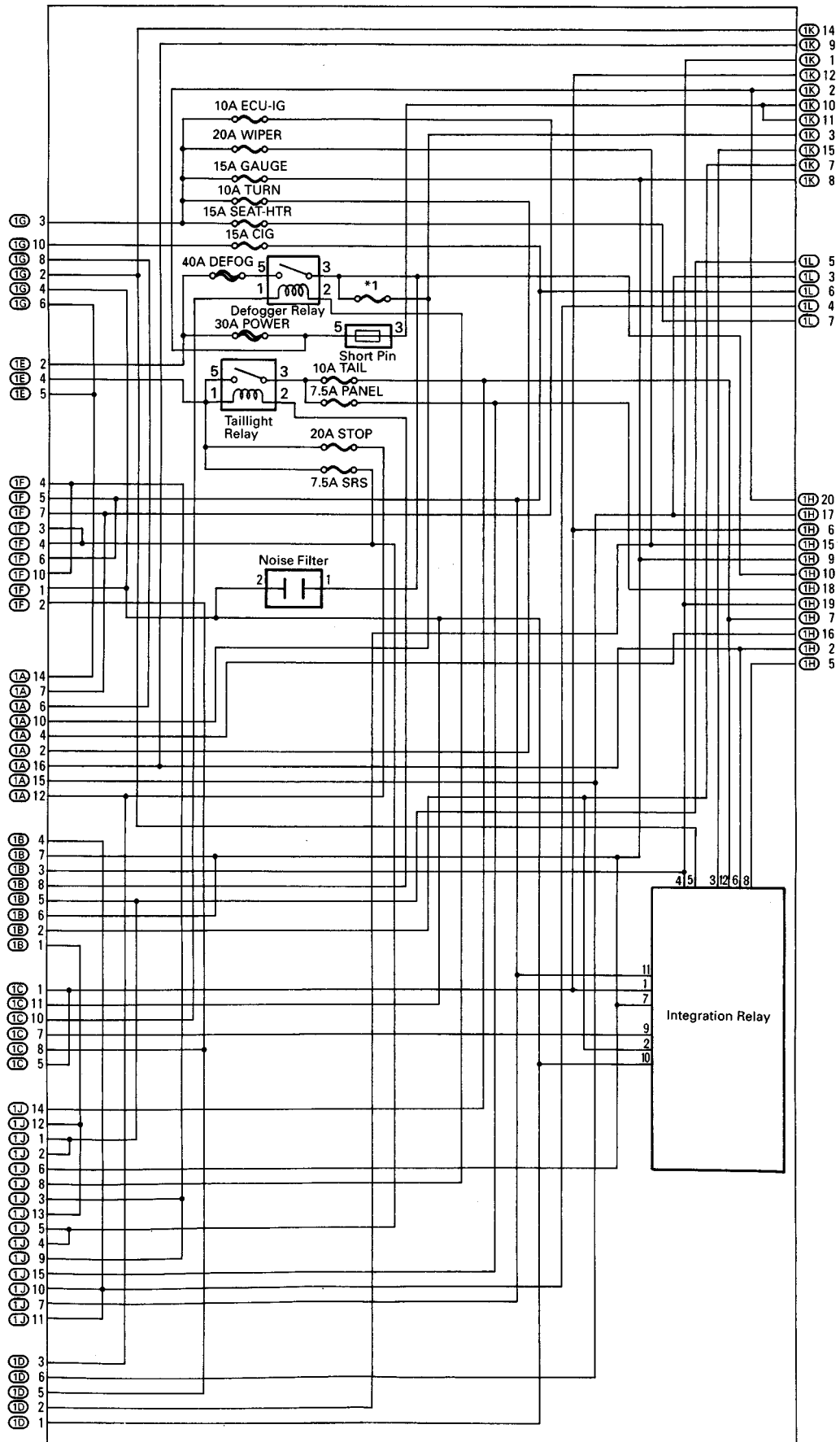

\*1: 10A MIR-HTR

# RELAY LOCATIONS

○ : J/B No. 3 Behind the Instrument Panel Center (See Page 18)

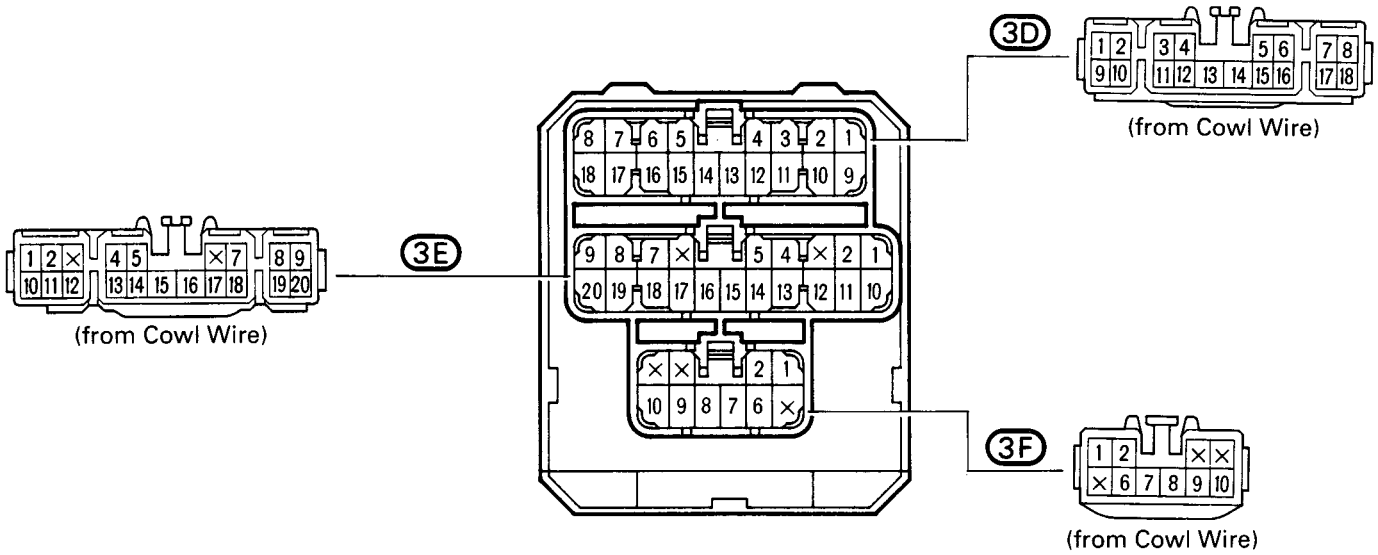
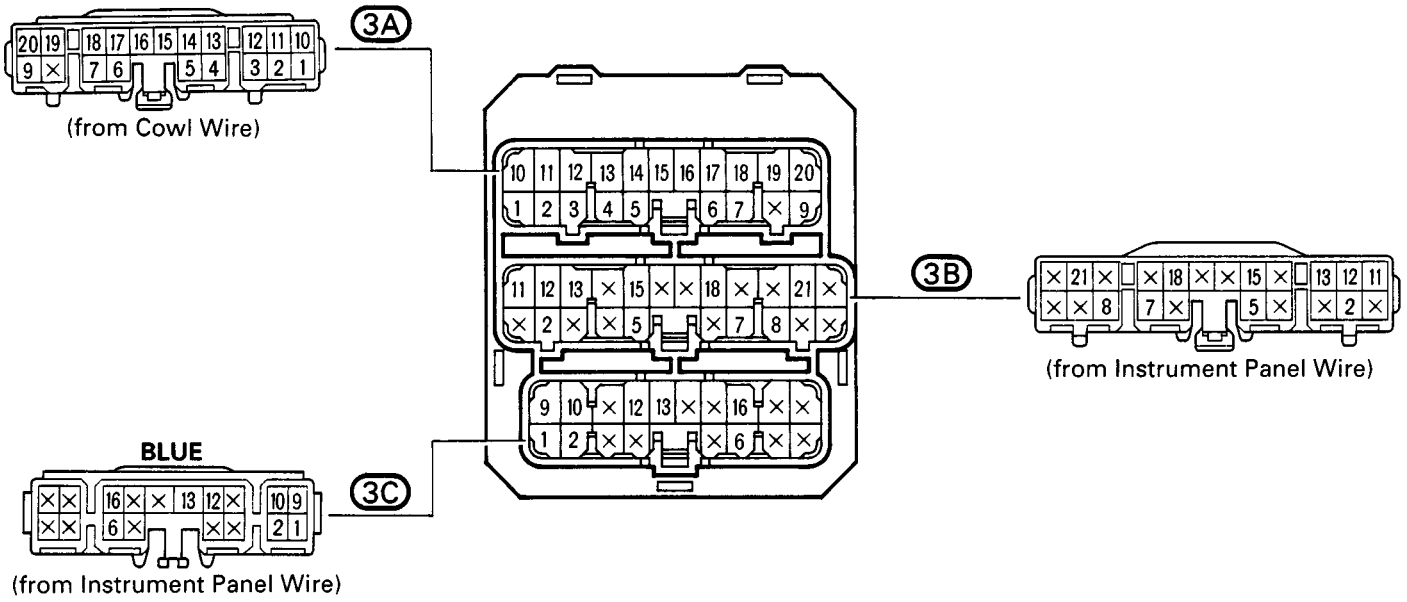

[J/B No. 3 Inner Circuit]

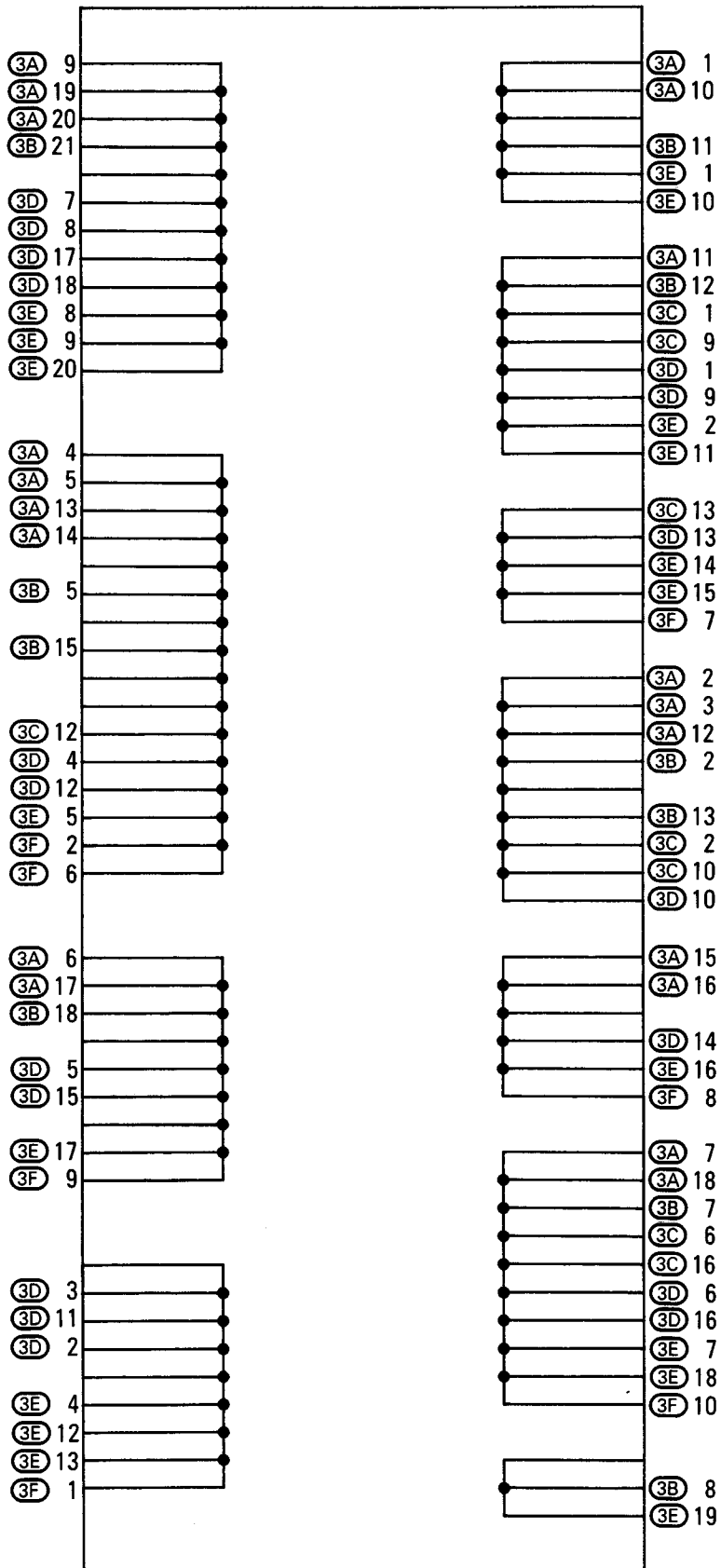

# RELAY LOCATIONS

⑥ : R/B No. 6	Left Kick Panel (See Page 18)
---------------	-------------------------------

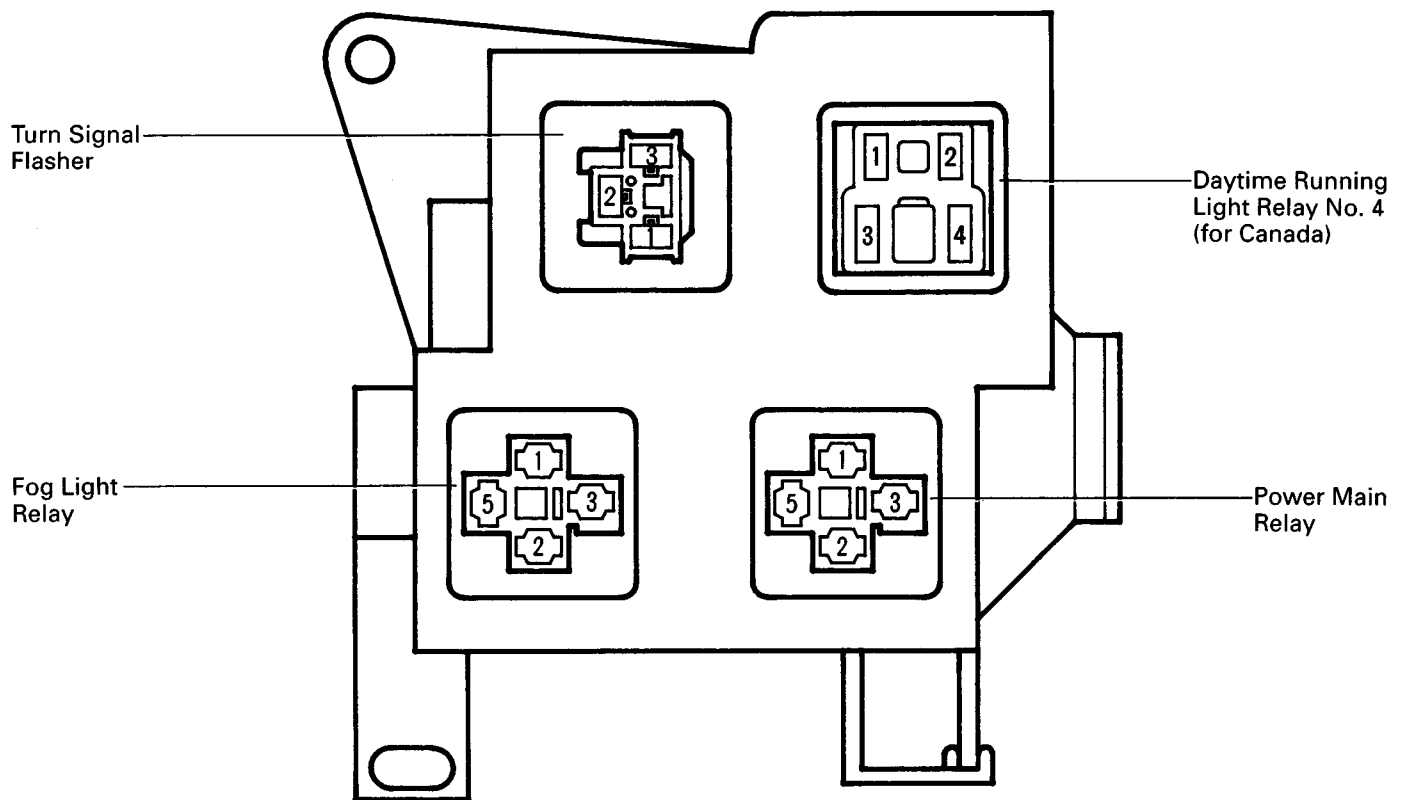



# ELECTRICAL WIRING ROUTING

## Position of Parts in Engine Compartment

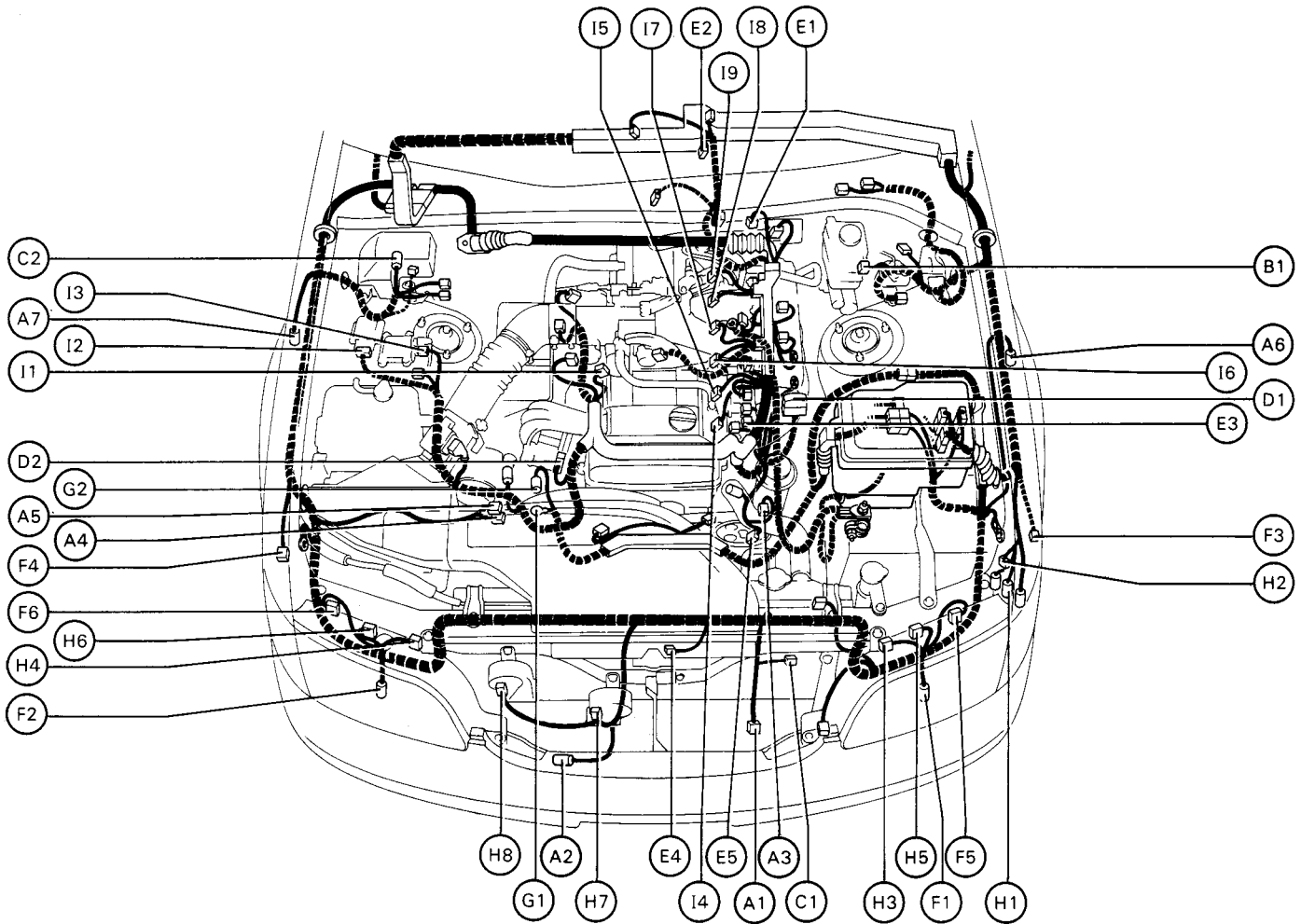

- A 1 A/C Ambient Temp. Sensor
- A 2 A/C Triple Pressure SW (A/C Dual and Single Pressure SW)
- A 3 A/C Lock Sensor and A/C Magnetic Clutch
- A 4 ABS Actuator
- A 5 ABS Actuator
- A 6 ABS Speed Sensor Front LH
- A 7 ABS Speed Sensor Front RH
  
- B 1 Brake Fluid Level Warning SW
  
- C 1 Condenser Fan Motor
- C 2 Cruise Control Actuator
  
- D 1 Data Link Connector 1 (Check Connector)
- D 2 Distributor
  
- E 1 EGR Gas Temp. Sensor
- E 2 Electronically Controlled Transmission Solenoid
- E 3 Engine Coolant Temp. Sensor (EFI Water Temp. Sensor)
- E 4 Engine Hood Courtesy SW
- E 5 Engine Oil Level Warning SW
  
- F 1 Fog Light LH
- F 2 Fog Light RH
- F 3 Front Airbag Sensor LH

- F 4 Front Airbag Sensor RH
- F 5 Front Turn Signal Light and Clearance Light LH
- F 6 Front Turn Signal Light and Clearance Light RH
  
- G 1 Generator (Alternator)
- G 2 Generator (Alternator)
  
- H 1 Headlight Cleaner Motor (for Canada)
- H 2 Headlight Cleaner Relay (for Canada)
- H 3 Headlight Hi LH
- H 4 Headlight Hi RH
- H 5 Headlight Lo LH
- H 6 Headlight Lo RH
- H 7 Horn (Low)
- H 8 Horn (High)
  
- I 1 Idle Air Control Valve (ISC Valve)
- I 2 Igniter
- I 3 Ignition Coil
- I 4 Injector No. 1
- I 5 Injector No. 2
- I 6 Injector No. 3
- I 7 Injector No. 4
- I 8 Injector No. 5
- I 9 Injector No. 6

## Position of Parts in Engine Compartment

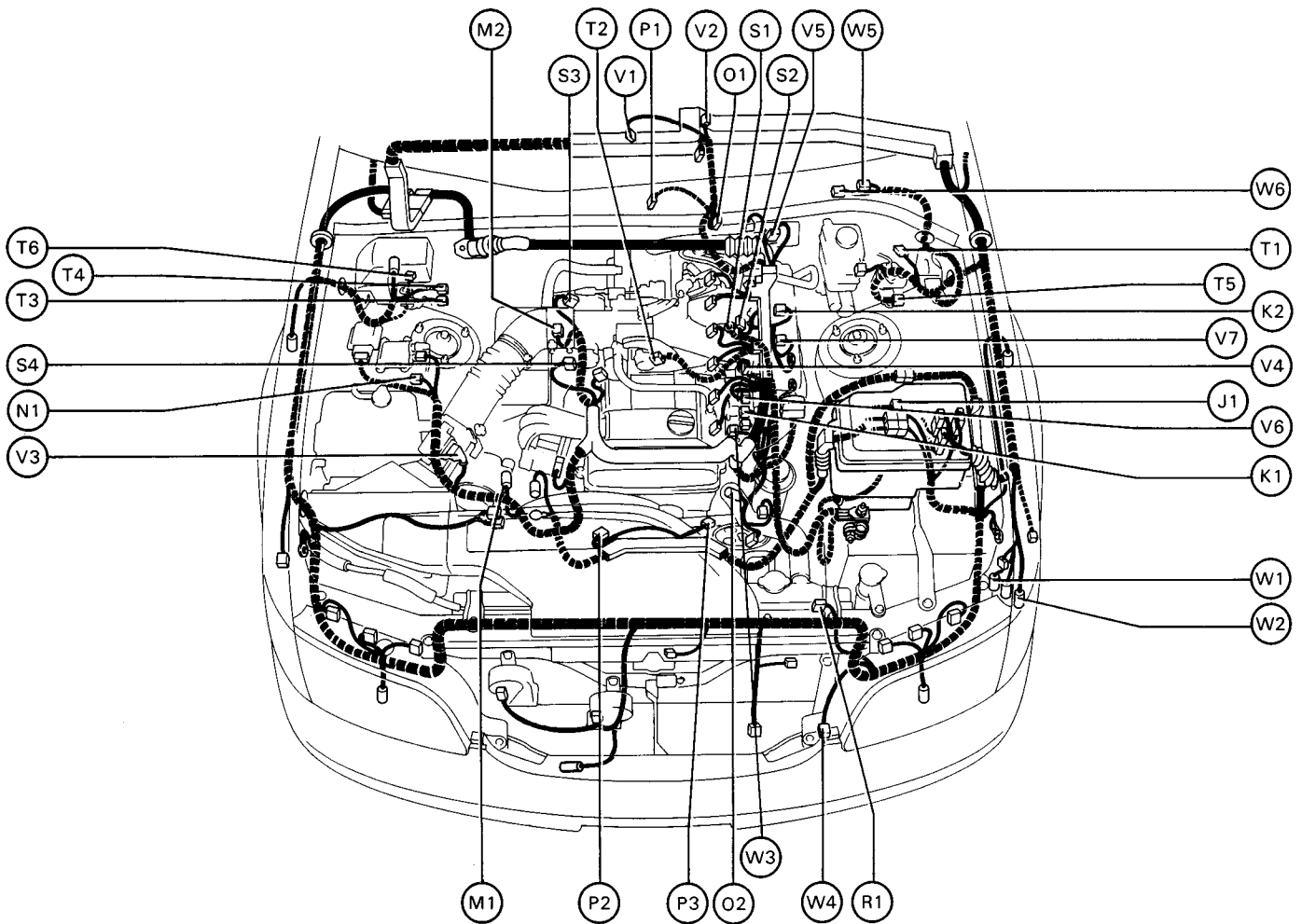

- |   |   |
|---|---|
| <p>J 1 Junction Connector</p> <p>K 1 Knock Sensor (on Front Side)</p> <p>K 2 Knock Sensor (on Rear Side)</p> <p>M 1 Main Heated Oxygen Sensor (on Front Side)</p> <p>M 2 Main Heated Oxygen Sensor (on Rear Side)</p> <p>N 1 Noise Filter (for Ignition System)</p> <p>O 1 O/D Direct Clutch Speed Sensor</p> <p>O 2 Oil Pressure SW</p> <p>P 1 Park/Neutral Position SW (Neutral Start SW), Back-Up Light SW and A/T Indicator Light SW</p> <p>P 2 Power Steering Pressure SW</p> <p>P 3 PPS Solenoid</p> <p>R 1 Radiator Fan Motor</p> <p>S 1 Starter</p> <p>S 2 Starter</p> <p>S 3 Sub Throttle Actuator</p> | <p>S 4 Sub Throttle Position Sensor</p> <p>T 1 Theft Deterrent Horn</p> <p>T 2 Throttle Position Sensor</p> <p>T 3 Traction Actuator</p> <p>T 4 Traction Actuator</p> <p>T 5 Traction Pump and Motor</p> <p>T 6 Traction Solenoid Relay</p> <p>V 1 Vehicle Speed Sensor (Speed Sensor) No. 1 (for Combination Meter)</p> <p>V 2 Vehicle Speed Sensor (Speed Sensor) No. 2 (for Electronically Controlled Transmission)</p> <p>V 3 Volume Air Flow (Air Flow Meter)</p> <p>V 4 VSV (for EGR)</p> <p>V 5 VSV (for EVAP)</p> <p>V 6 VSV (for Fuel Pressure Up)</p> <p>V 7 VSV (for Intake Control)</p> <p>W 1 Washer Level Warning SW</p> <p>W 2 Washer Motor</p> <p>W 3 Washer Temp. Sender</p> <p>W 4 Water Temp. SW</p> <p>W 5 Wiper Angle Control Motor</p> <p>W 6 Wiper Motor</p> |
|---|---|

# ELECTRICAL WIRING ROUTING

## Position of Parts in Instrument Panel

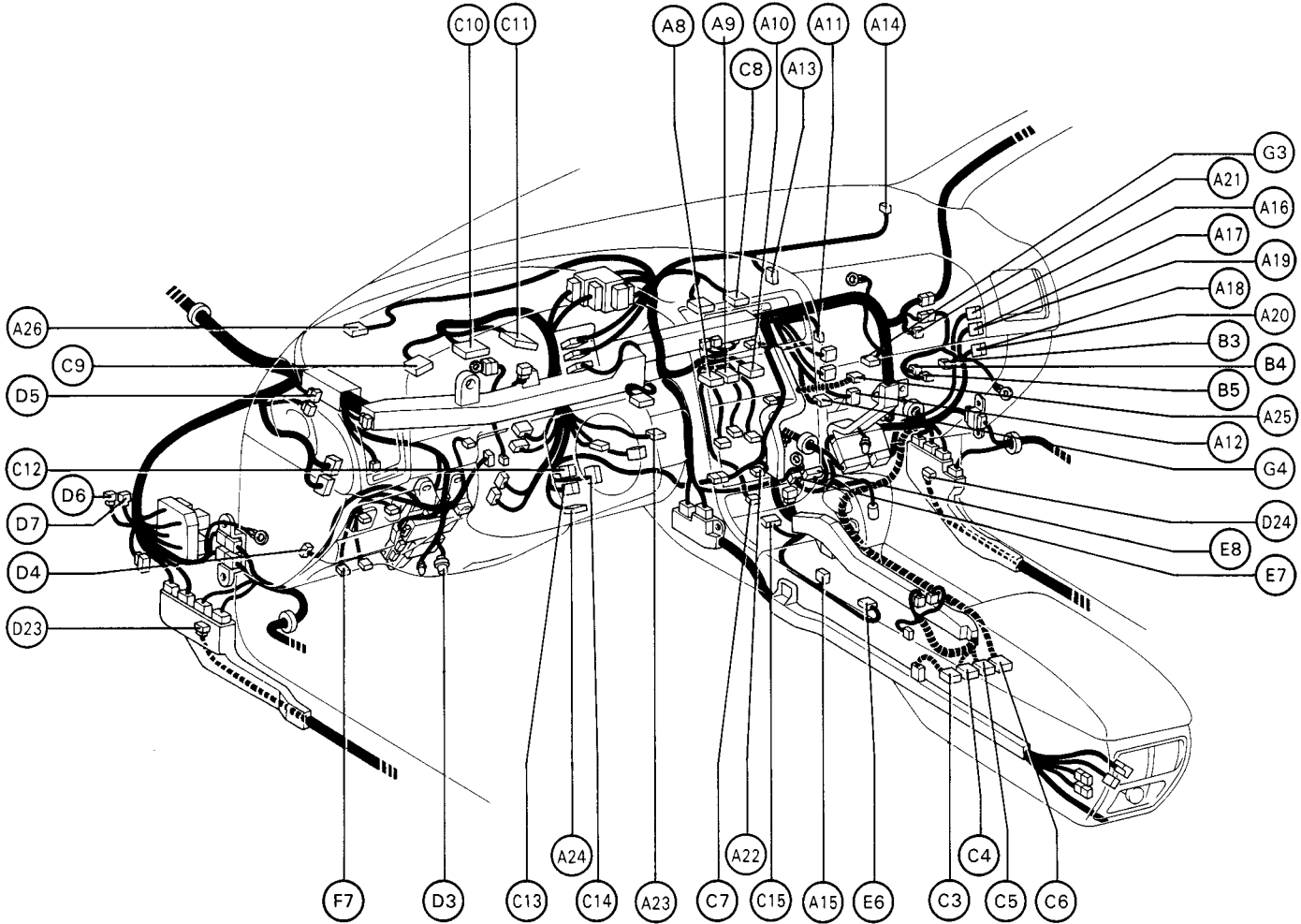

- |      |                                       |      |   |
|------|---------------------------------------|------|---|
| A 8  | A/C Control Assembly                  | C 8  | Clock   |
| A 9  | A/C Control Assembly                  | C 9  | Combination Meter   |
| A 10 | A/C Control Assembly                  | C 10 | Combination Meter   |
| A 11 | A/C Evaporator Temp. Sensor           | C 11 | Combination Meter   |
| A 12 | A/C Look Amplifier                    | C 12 | Combination SW  |
| A 13 | A/C Room Temp. Sensor                 | C 13 | Combination SW  |
| A 14 | A/C Solar Sensor                      | C 14 | Combination SW  |
| A 15 | A/T Indicator Light (for Shift Lever) | C 15 | Cruise Control ECU  |
| A 16 | ABS and Traction ECU                  | D 3  | Data Link Connector 2 (TDCL)  |
| A 17 | ABS and Traction ECU                  | D 4  | Daytime Running Light Relay   |
| A 18 | ABS and Traction ECU                  | D 5  | Diode (for Headlight Cleaner) (for Canada)                                    |
| A 19 | ABS ECU (w/o Traction Control)        | D 6  | Diode (for Idle-Up)   |
| A 20 | ABS ECU (w/o Traction Control)        | D 7  | Diode (for Traction Control)  |
| A 21 | Air Inlet Control Servo Motor         | D 23 | Diode (for Interior Light)  |
| A 22 | Air Mix Control Servo Motor           | D 24 | Diode (for Interior Light)  |
| A 23 | Air Vent Mode Control Servo Motor     | E 6  | Electronically Controlled Transmission Pattern Select SW                      |
| A 24 | Airbag Squib (for Driver's)           | E 7  | Engine Control Module (Engine and Electronically Controlled Transmission ECU) |
| A 25 | Airbag Squib (for Passenger's)        | E 8  | Engine Control Module (Engine and Electronically Controlled Transmission ECU) |
| A 26 | Automatic Light Control Sensor        | F 7  | Fuel Lid Opener SW  |
| B 3  | Blower Motor                          | G 3  | Glove Box Light   |
| B 4  | Blower Motor Control Relay            | G 4  | Glove Box Light SW  |
| B 5  | Blower Motor Control Relay            |      |   |
| C 3  | Center Airbag Sensor Assembly         |      |   |
| C 4  | Center Airbag Sensor Assembly         |      |   |
| C 5  | Center Airbag Sensor Assembly         |      |   |
| C 6  | Center Airbag Sensor Assembly         |      |   |
| C 7  | Cigarette Lighter                     |      |   |

## Position of Parts in Instrument Panel

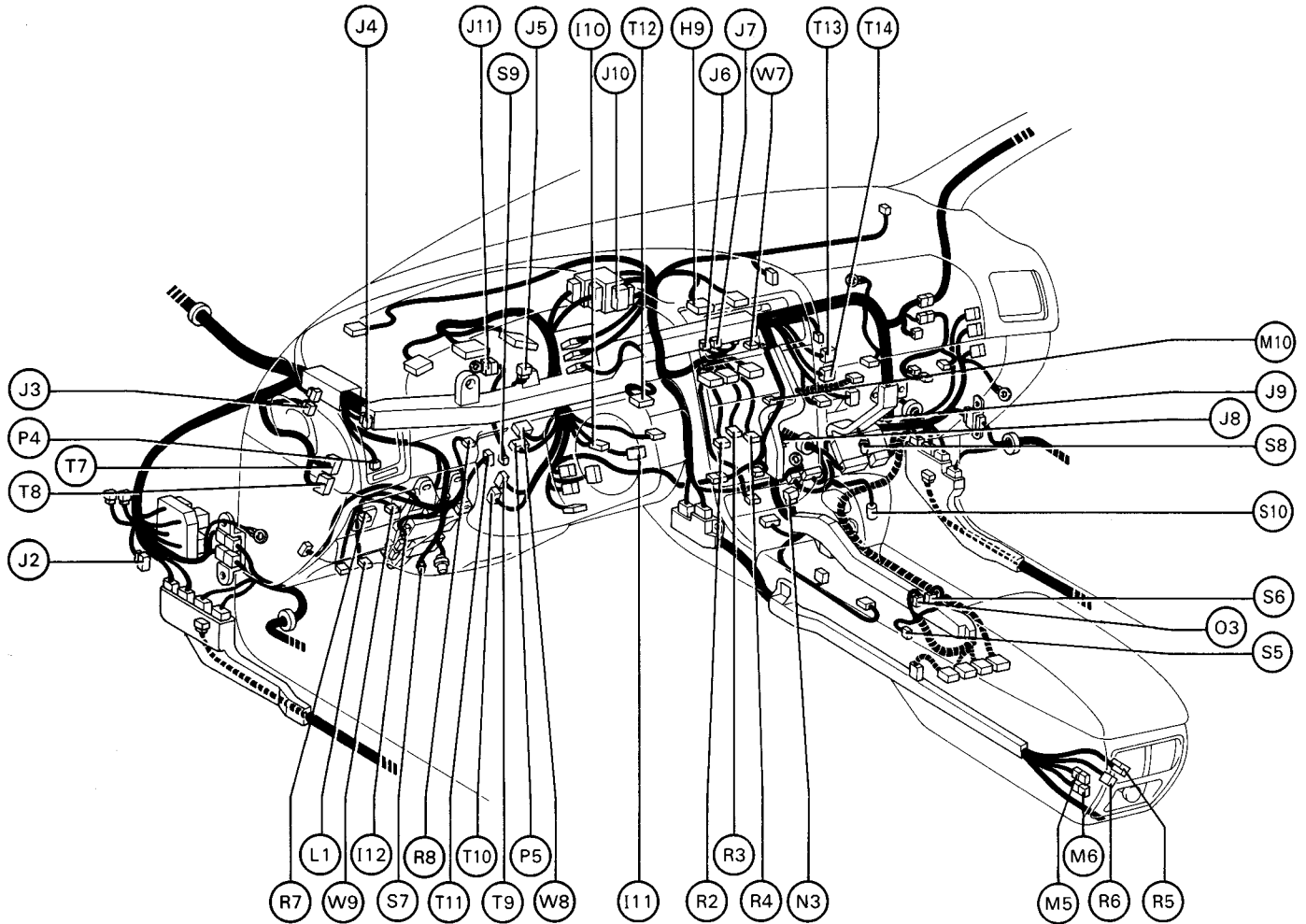

- |   |  |
|---|--|
| <p>H 9 Hazard SW</p> <p>I 10 Ignition Key Cylinder Light</p> <p>I 11 Ignition SW, Unlock Warning SW and Key Interlock Solenoid</p> <p>I 12 Integration Relay</p> <p>J 2 Junction Connector</p> <p>J 3 Junction Connector</p> <p>J 4 Junction Connector</p> <p>J 5 Junction Connector</p> <p>J 6 Junction Connector</p> <p>J 7 Junction Connector</p> <p>J 8 Junction Connector</p> <p>J 9 Junction Connector</p> <p>J 10 Junction Connector</p> <p>J 11 Junction Connector (for Earth)</p> <p>L 1 Luggage Compartment Door Open SW</p> <p>M 5 Mobilephone</p> <p>M 6 Mobilephone</p> <p>M 10 Max Cool Control Servo Motor</p> <p>N 3 Noise Filter</p> <p>O 3 O/D Main SW</p> <p>P 4 Parking Brake SW</p> <p>P 5 PPS ECU</p> | <p>R 2 Radio and Player</p> <p>R 3 Radio and Player</p> <p>R 4 Radio and Player</p> <p>R 5 Rear Cigarette Lighter</p> <p>R 6 Rear Cigarette Lighter Illumination</p> <p>R 7 Remote Control Mirror SW</p> <p>R 8 Rheostat</p> <p>S 5 Seat Heater SW</p> <p>S 6 Shift Lock ECU</p> <p>S 7 Step Light LH</p> <p>S 8 Step Light RH</p> <p>S 9 Stop Light SW</p> <p>S 10 Sub Heated Oxygen Sensor</p> <p>T 7 Theft Deterrent ECU</p> <p>T 8 Theft Deterrent ECU</p> <p>T 9 Tilt and Power Telescopic ECU</p> <p>T 10 Tilt and Power Telescopic ECU</p> <p>T 11 Tilt and Power Telescopic Sensor and Motor</p> <p>T 12 Traction Cut SW</p> <p>T 13 Traction ECU</p> <p>T 14 Traction ECU</p> <p>W 7 Water Temp. Sensor (for A/C System)</p> <p>W 8 Wiper Relay</p> <p>W 9 Wireless Door Lock Main SW</p> |
|---|--|

# ELECTRICAL WIRING ROUTING

## Position of Parts in Body

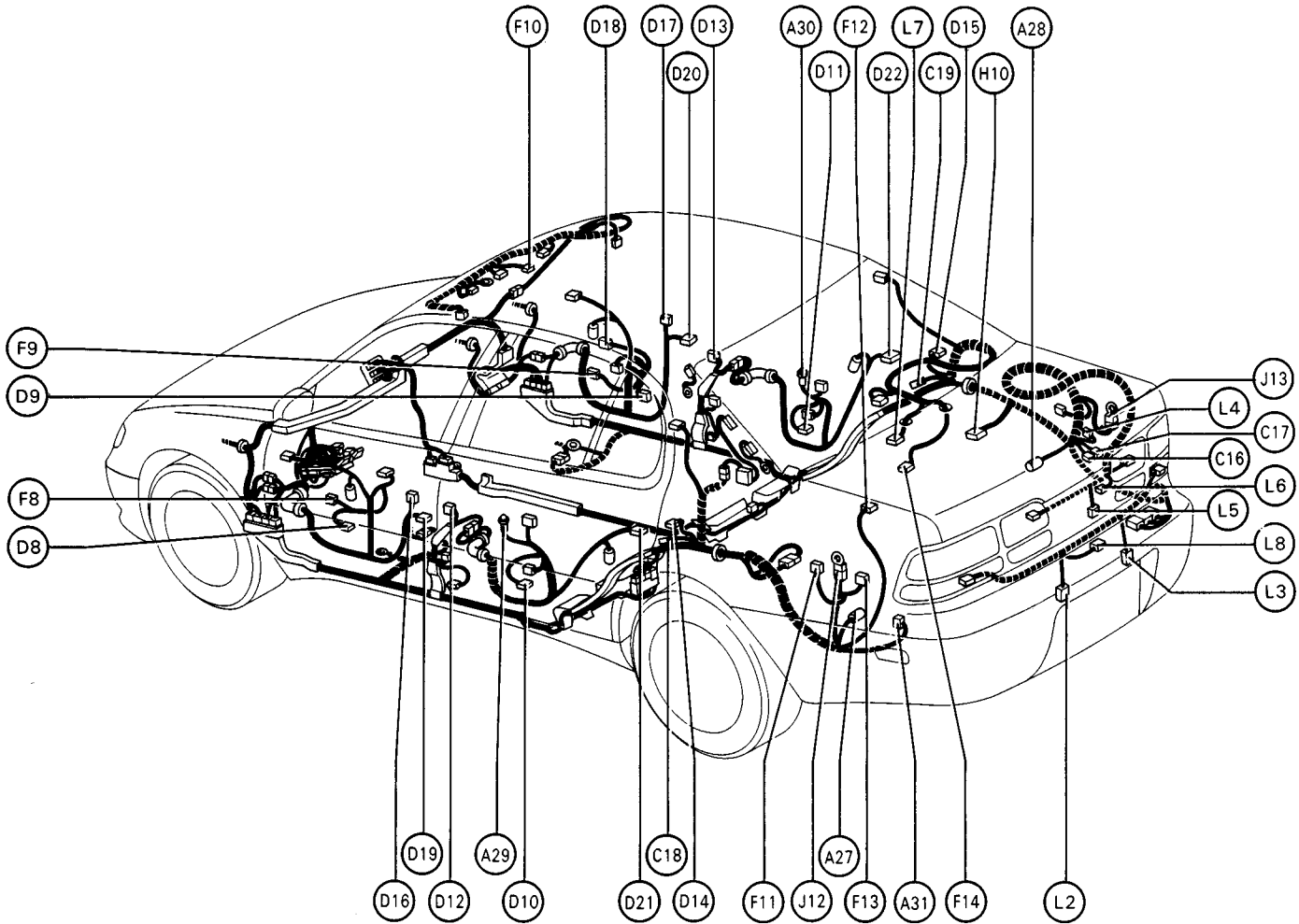

- A 27 ABS Speed Sensor Rear LH
- A 28 ABS Speed Sensor Rear RH
- A 29 Ashtray Illumination Rear LH
- A 30 Ashtray Illumination Rear RH
- A 31 Auto Antenna Motor and Relay

- C 16 CD Automatic Changer
- C 17 CD Automatic Changer
- C 18 Condenser LH
- C 19 Condenser RH

- D 8 Door Courtesy Light Front LH
- D 9 Door Courtesy Light Front RH
- D 10 Door Courtesy Light Rear LH
- D 11 Door Courtesy Light Rear RH
- D 12 Door Courtesy SW Front LH
- D 13 Door Courtesy SW Front RH
- D 14 Door Courtesy SW Rear LH
- D 15 Door Courtesy SW Rear RH
- D 16 Door Key Lock and Unlock SW Front LH
- D 17 Door Key Lock and Unlock SW Front RH
- D 18 Door Lock Control SW RH
- D 19 Door Lock Motor and Door Unlock Detection SW Front LH
- D 20 Door Lock Motor and Door Unlock Detection SW Front RH

- D 21 Door Lock Motor and Door Unlock Detection SW Rear LH
- D 22 Door Lock Motor and Door Unlock Detection SW Rear RH

- F 8 Front Door Speaker LH
- F 9 Front Door Speaker RH
- F 10 Front Personal Light
- F 11 Fuel Lid Opener Motor
- F 12 Fuel Pump
- F 13 Fuel Pump ECU
- F 14 Fuel Sender

- H 10 High Mounted Stop Light

- J 12 Junction Connector (for Earth)
- J 13 Junction Connector (for Earth)

- L 2 License Plate Light LH
- L 3 License Plate Light RH
- L 4 Light Failure Sensor
- L 5 Luggage Compartment Door Opener Motor
- L 6 Luggage Compartment Key Unlock SW
- L 7 Luggage Compartment Light
- L 8 Luggage Compartment Light SW

## Position of Parts in Body

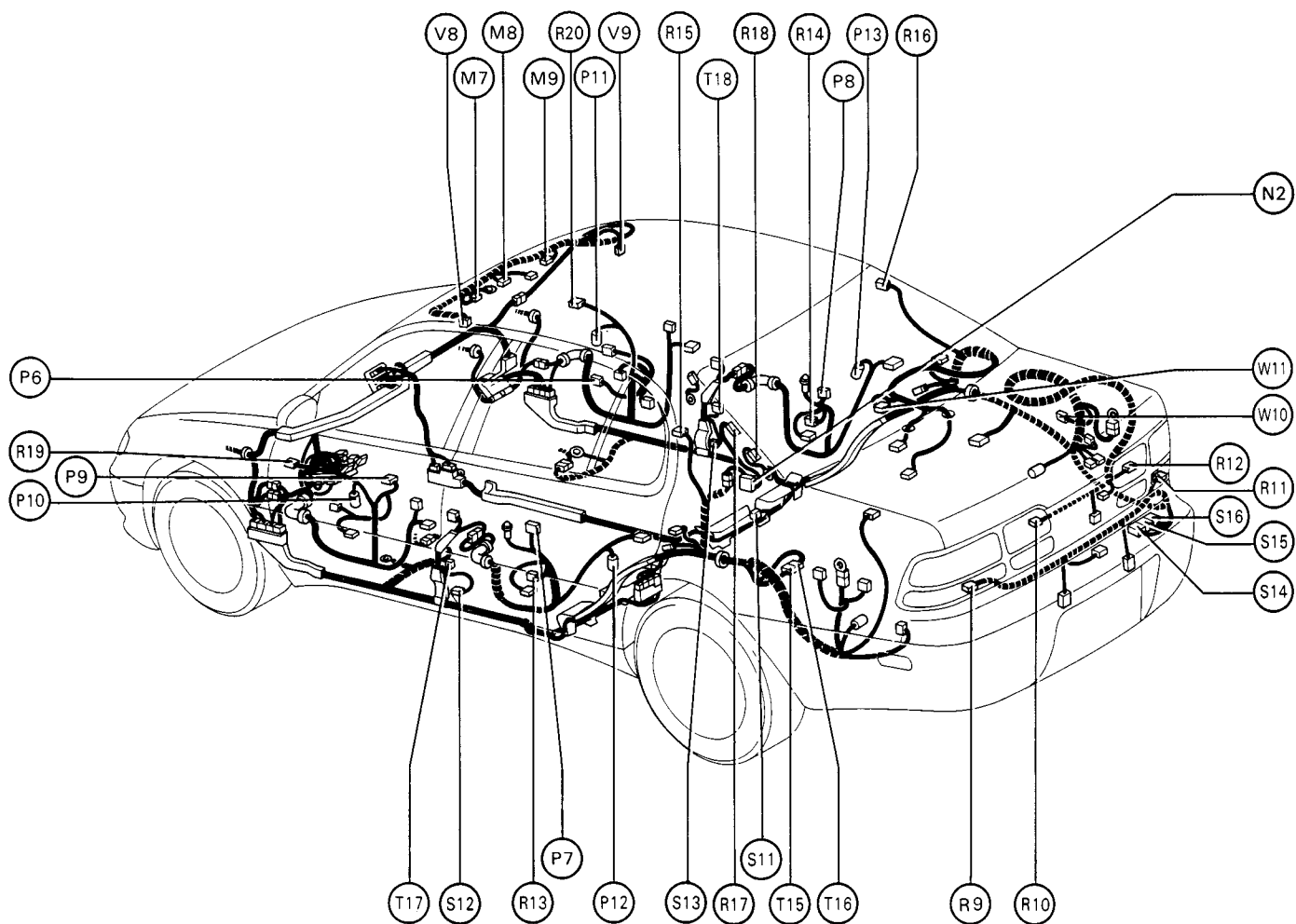

- |  |  |
|--|--|
| <p>M 7 Moon Roof Control Relay<br/>                     M 8 Moon Roof Control SW<br/>                     M 9 Moon Roof Motor and Limit SW</p> <p>N 2 Noise Filter (for Rear Window Defogger)</p> <p>P 6 Power Window Control SW Front RH<br/>                     P 7 Power Window Control SW Rear LH<br/>                     P 8 Power Window Control SW Rear RH<br/>                     P 9 Power Window Master SW and Door Lock Control SW<br/>                     P 10 Power Window Motor Front LH<br/>                     P 11 Power Window Motor Front RH<br/>                     P 12 Power Window Motor Rear LH<br/>                     P 13 Power Window Motor Rear RH</p> <p>R 9 Rear Combination Light LH<br/>                     R 10 Rear Combination Light LH<br/>                     R 11 Rear Combination Light RH<br/>                     R 12 Rear Combination Light RH<br/>                     R 13 Rear Door Speaker LH<br/>                     R 14 Rear Door Speaker RH<br/>                     R 15 Rear Personal Light LH</p> | <p>R 16 Rear Personal Light RH<br/>                     R 17 Rear Window Defogger (+)<br/>                     R 18 Rear Window Defogger (-)<br/>                     R 19 Remote Control Mirror and Mirror Heater LH<br/>                     R 20 Remote Control Mirror and Mirror Heater RH</p> <p>S 11 Seat Belt Pretensioner Check Connector<br/>                     S 12 Seat Belt Pretensioner LH<br/>                     S 13 Seat Belt Pretensioner RH<br/>                     S 14 Stereo Component Amplifier<br/>                     S 15 Stereo Component Amplifier<br/>                     S 16 Stereo Component Amplifier</p> <p>T 15 Telephone Transceiver and Speaker Relay<br/>                     T 16 Telephone Transceiver and Speaker Relay<br/>                     T 17 Tension Reducer Solenoid LH<br/>                     T 18 Tension Reducer Solenoid RH</p> <p>V 8 Vanity Light LH<br/>                     V 9 Vanity Light RH</p> <p>W 10 Wireless Door Lock ECU<br/>                     W 11 Woofer Speaker</p> |
|--|--|

# ELECTRICAL WIRING ROUTING

## Position of Parts in Seat

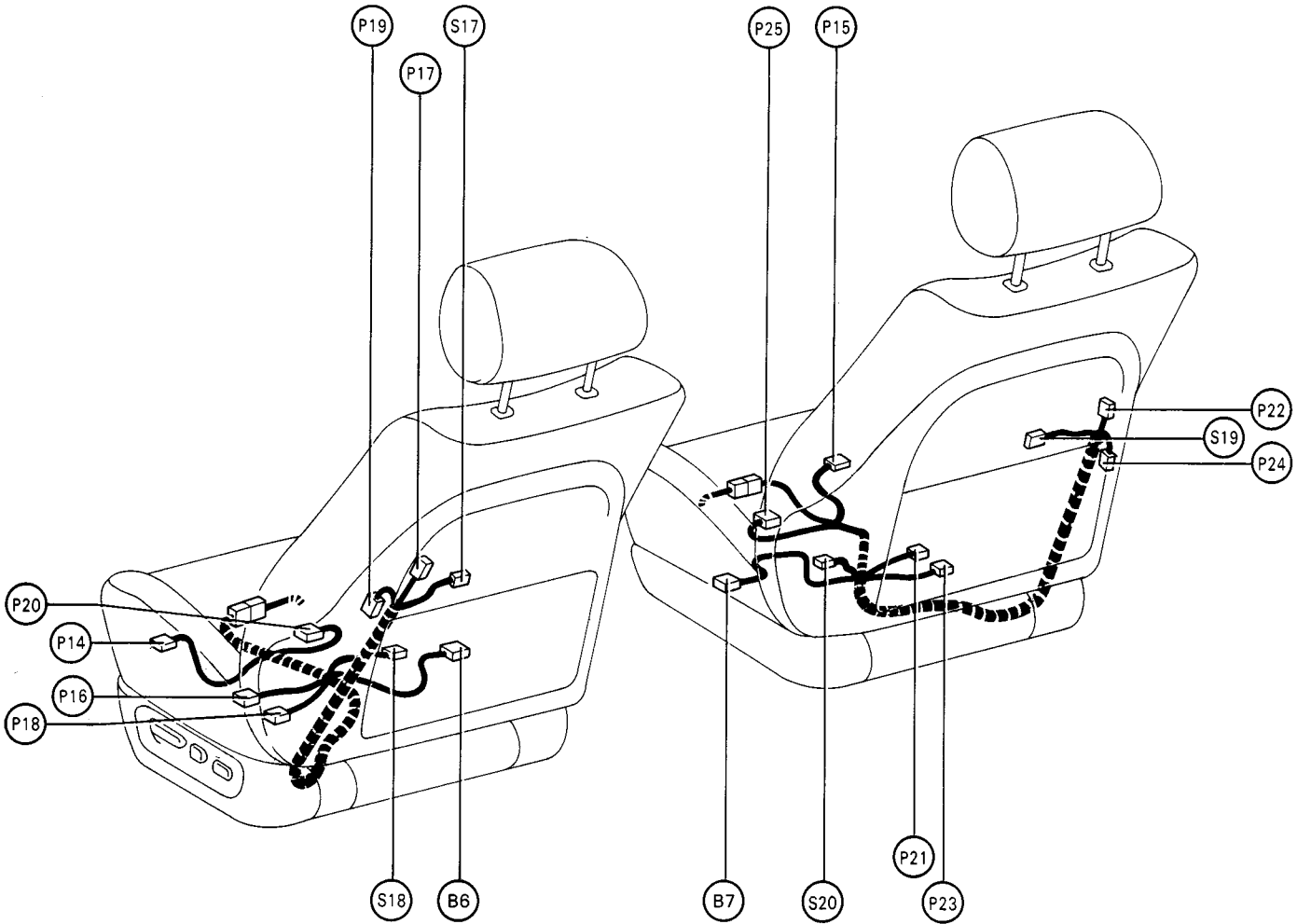

B 6 Buckle SW LH  
 B 7 Buckle SW RH

P 14 Power Seat Control SW (for Driver's Seat)  
 P 15 Power Seat Control SW (for Passenger's Seat)  
 P 16 Power Seat Motor (for Driver's Seat Front Vertical Control)  
 P 17 Power Seat Motor (for Driver's Seat Lumbar Support Control)  
 P 18 Power Seat Motor (for Driver's Seat Rear Vertical Control)  
 P 19 Power Seat Motor (for Driver's Seat Reclining Control)  
 P 20 Power Seat Motor (for Driver's Seat Slide Control)  
 P 21 Power Seat Motor (for Passenger's Seat Front Vertical Control)

P 22 Power Seat Motor (for Passenger's Seat Lumbar Support Control)  
 P 23 Power Seat Motor (for Passenger's Seat Rear Vertical Control)  
 P 24 Power Seat Motor (for Passenger's Seat Reclining Control)  
 P 25 Power Seat Motor (for Passenger's Seat Slide Control)  
 S 17 Seat Heater (for Driver's Seat Back)  
 S 18 Seat Heater (for Driver's Seat Cushion)  
 S 19 Seat Heater (for Passenger's Seat Back)  
 S 20 Seat Heater (for Passenger's Seat Cushion)

# ELECTRICAL WIRING ROUTING

- : Location of Connector Joining Wire Harness and Wire Harness
- ▽ : Location of Ground Points

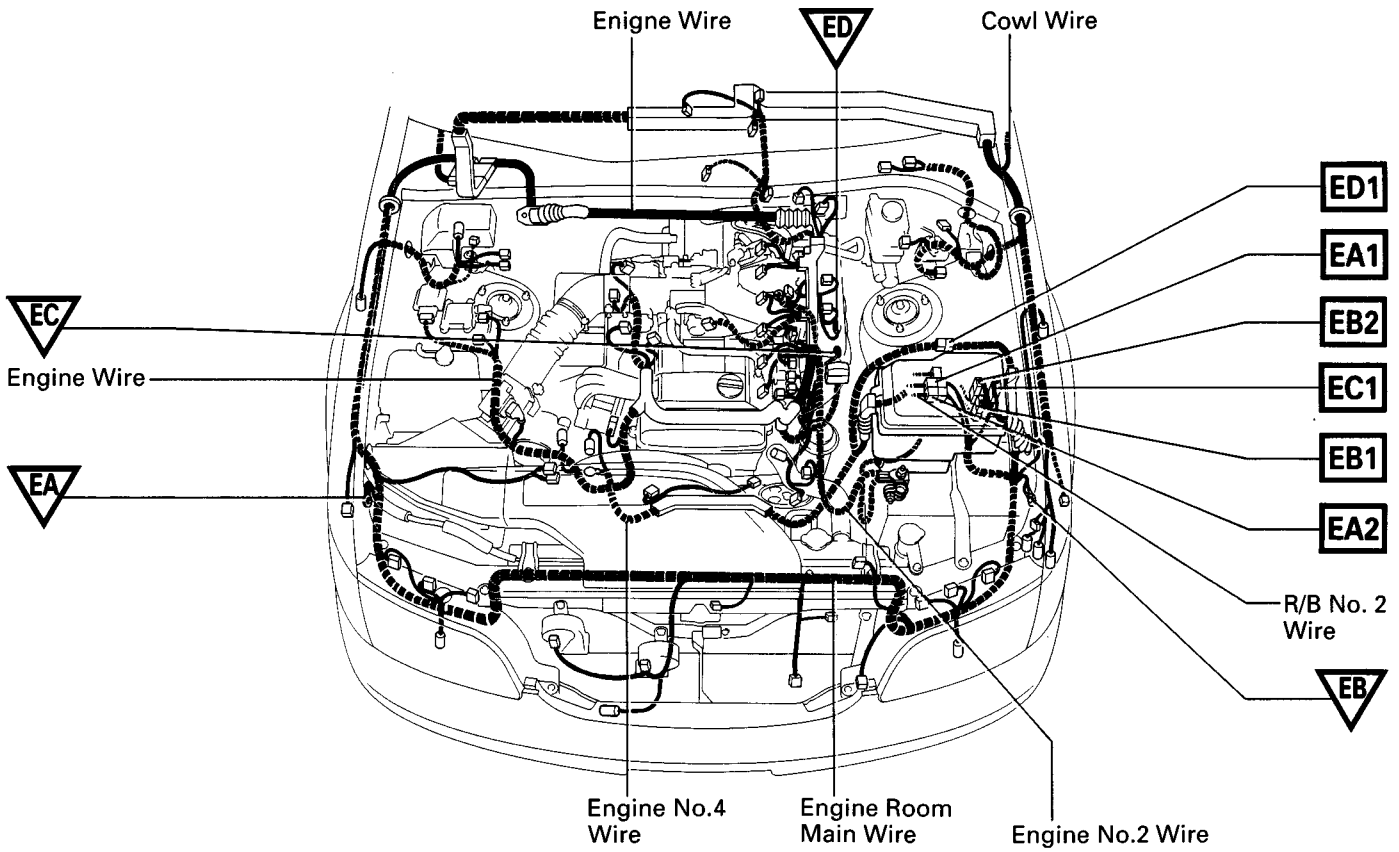

- : Location of Splice Points

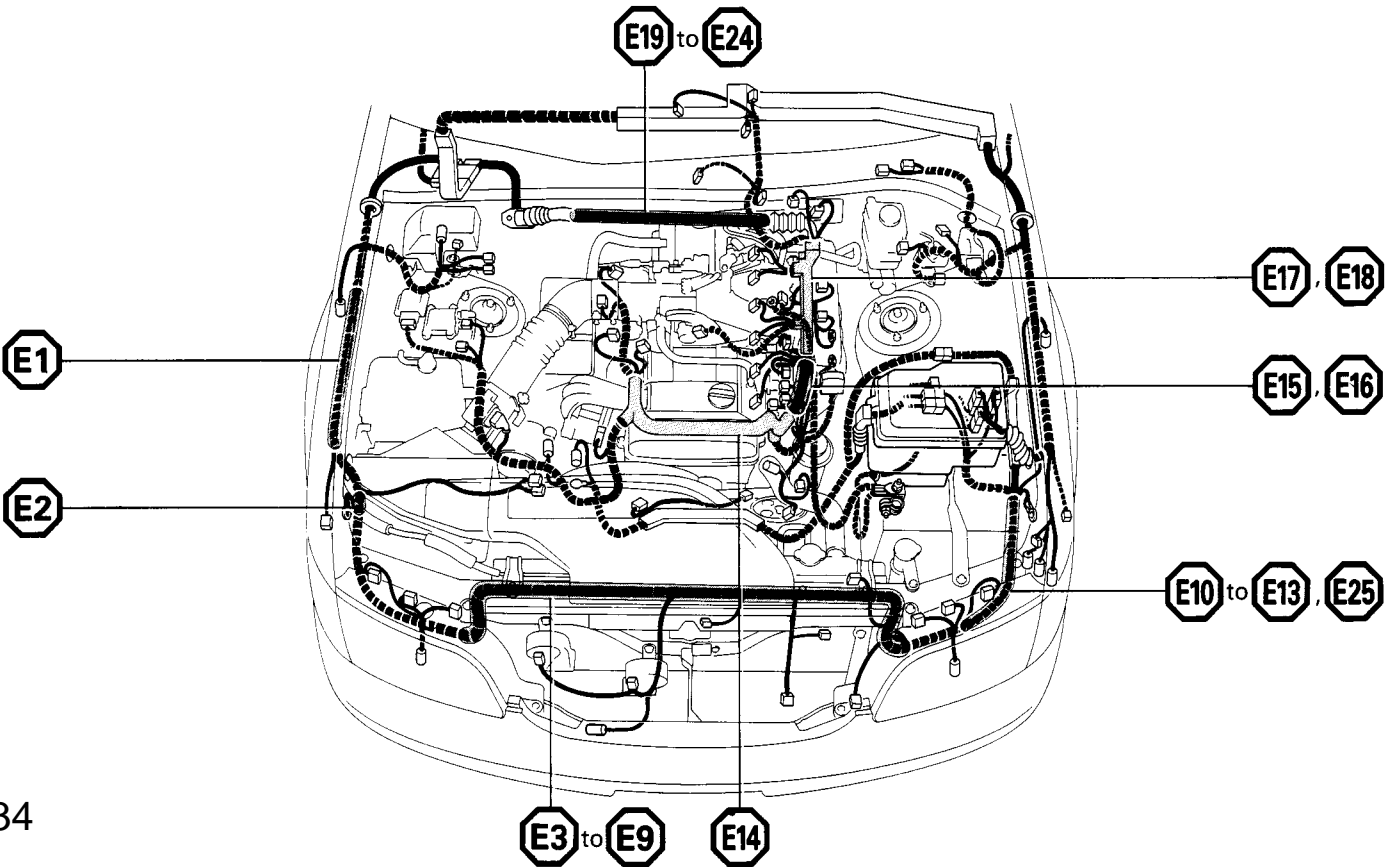



# Connector Joining Wire Harness and Wire Harness

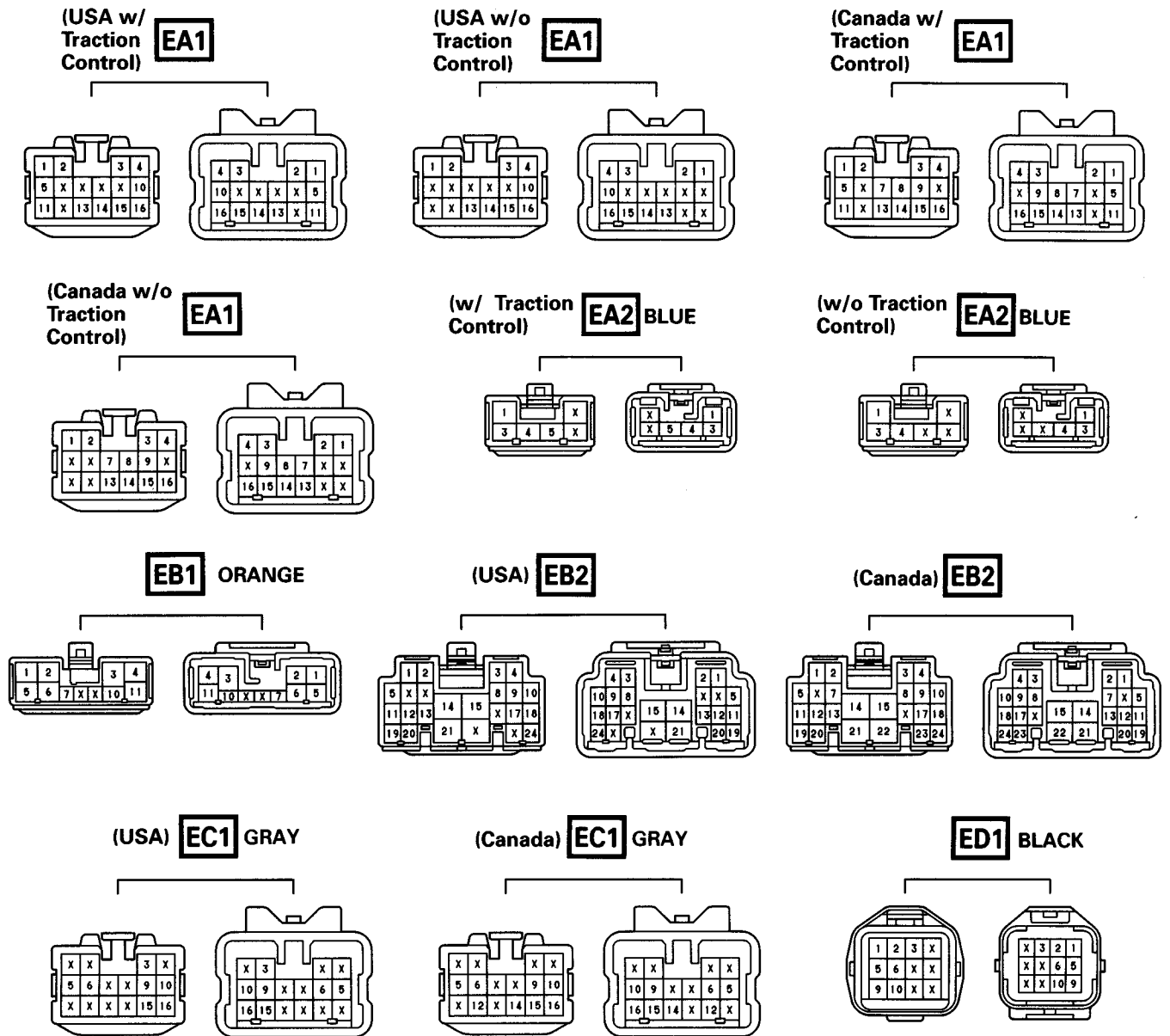

CODE	JOINING WIRE HARNESS AND WIRE HARNESS (CONNECTOR LOCATION)
EA1	ENGINE ROOM MAIN WIRE AND R/B NO. 2 WIRE (INSIDE OF R/B NO. 2)
EA2	ENGINE ROOM MAIN WIRE AND R/B NO. 2 WIRE (INSIDE OF R/B NO. 2)
EB1	COWL WIRE AND R/B NO. 2 WIRE (INSIDE OF R/B NO. 2)
EB2	COWL WIRE AND R/B NO. 2 WIRE (INSIDE OF R/B NO. 2)
EC1	COWL WIRE AND ENGINE ROOM MAIN WIRE (INSIDE OF R/B NO. 2)
ED1	ENGINE ROOM MAIN WIRE AND ENGINE NO. 4 WIRE (NEAR THE R/B NO. 2)

# ELECTRICAL WIRING ROUTING

□ : Location of Connector Joining Wire Harness and Wire Harness

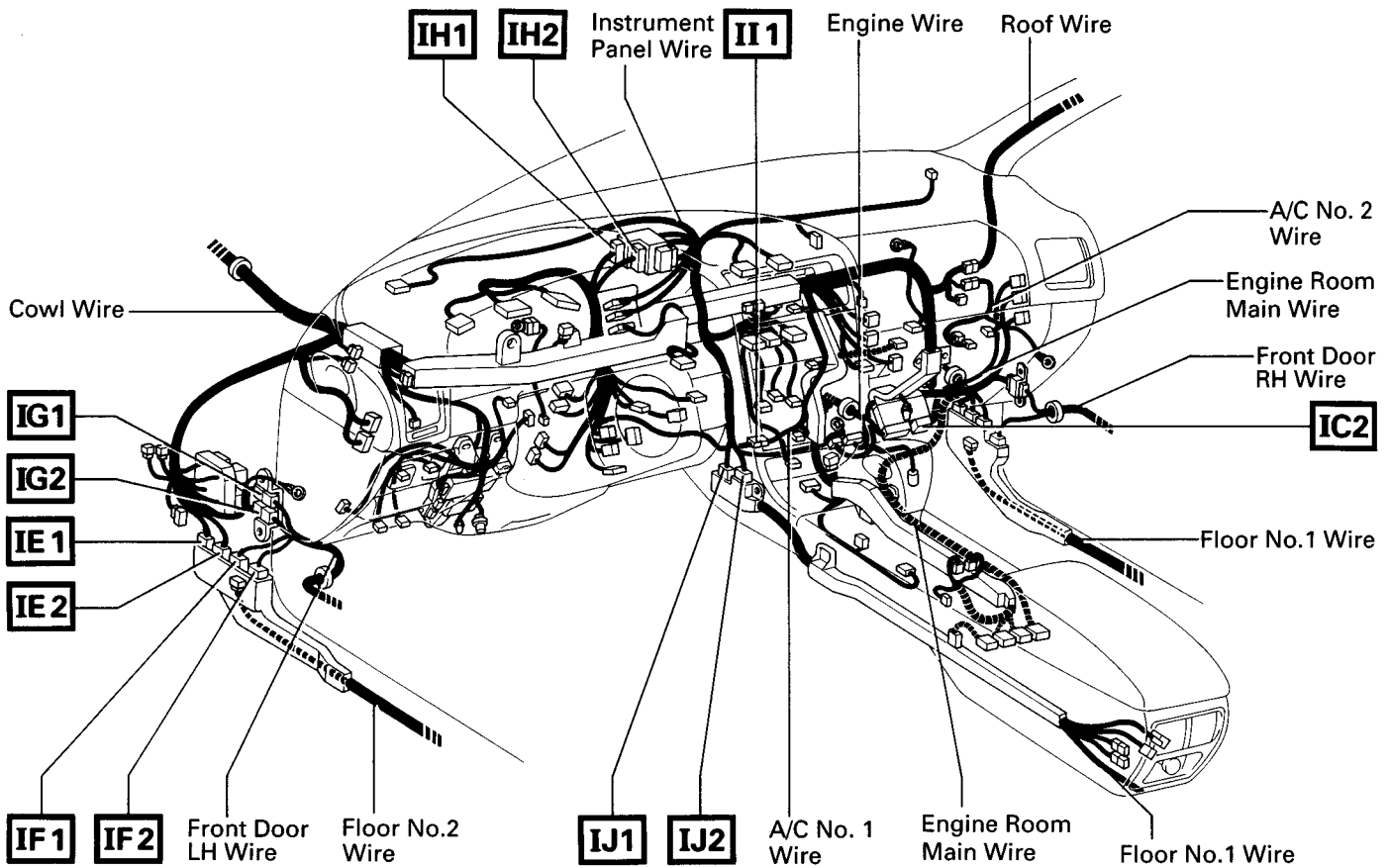

▽ : Location of Ground Points

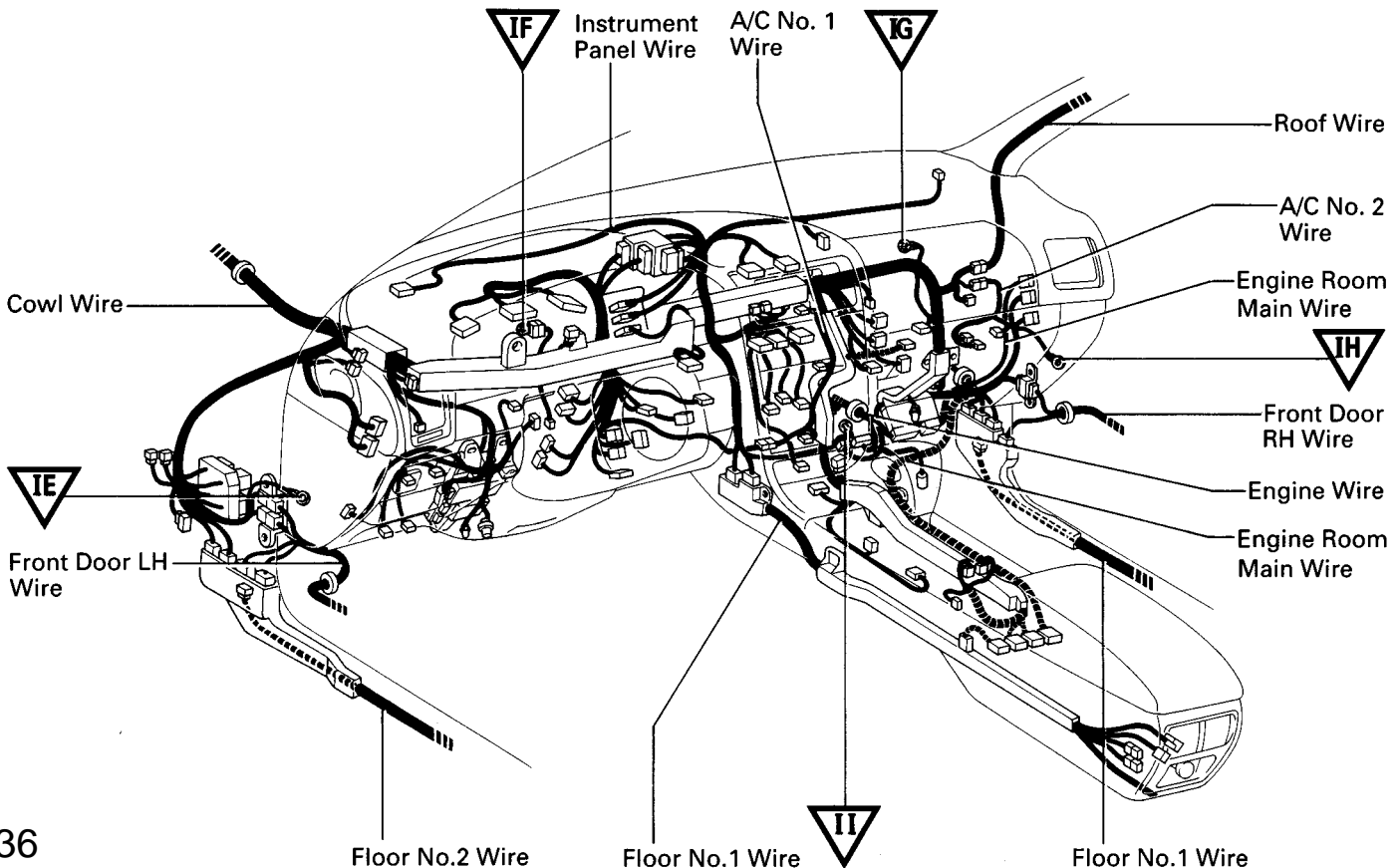

# Connector Joining Wire Harness and Wire Harness

**IC2** DARK GRAY

**IE1**

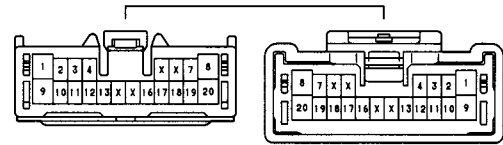
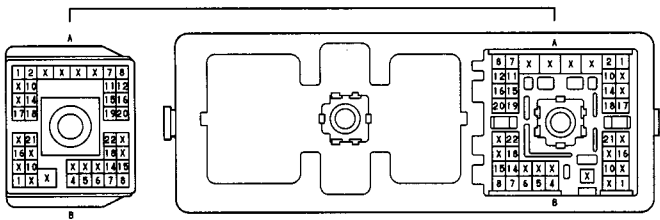

**IE2** BLUE

**IF1** ORANGE

**IF2** GRAY

**IG1**

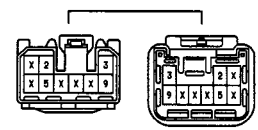
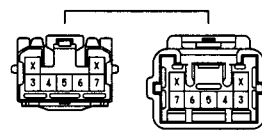
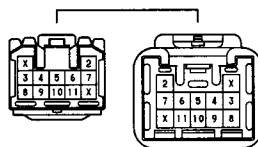
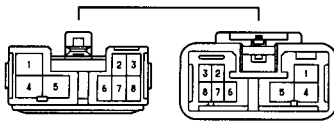

**IG2** BLUE

(USA) **IH1** BLUE

(Canada) **IH1** BLUE

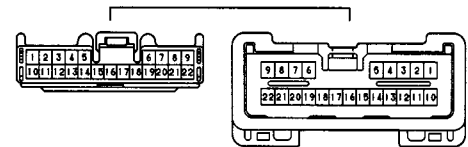
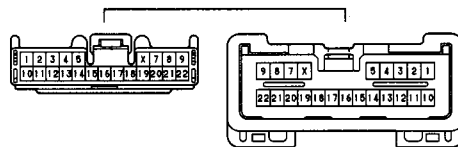
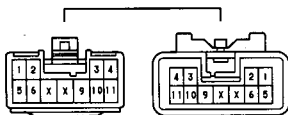

**IH2**

**II1**

**IJ1**

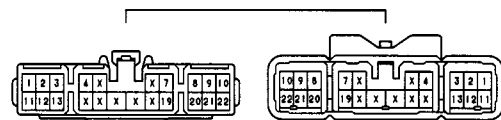
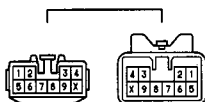
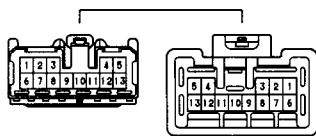

**IJ2**

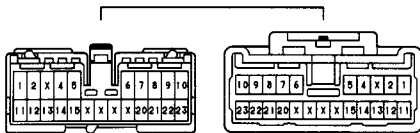

CODE	JOINING WIRE HARNESS AND WIRE HARNESS (CONNECTOR LOCATION)
IC2	ENGINE ROOM MAIN WIRE AND COWL WIRE (UNDER THE GLOVE BOX)
IE1	COWL WIRE AND FLOOR NO. 2 WIRE (LEFT KICK PANEL)
IE2	COWL WIRE AND FLOOR NO. 2 WIRE (LEFT KICK PANEL)
IF1	FRONT DOOR LH WIRE AND FLOOR NO. 2 WIRE (LEFT KICK PANEL)
IF2	FRONT DOOR LH WIRE AND FLOOR NO. 2 WIRE (LEFT KICK PANEL)
IG1	FRONT DOOR LH WIRE AND COWL WIRE (LEFT KICK PANEL)
IG2	FRONT DOOR LH WIRE AND COWL WIRE (LEFT KICK PANEL)
IH1	COWL WIRE AND INSTRUMENT PANEL WIRE (BEHIND GLOVE BOX)
IH2	COWL WIRE AND INSTRUMENT PANEL WIRE (BEHIND GLOVE BOX)
II1	COWL WIRE AND A/C SUB NO. 1 WIRE (INSTRUMENT PANEL CENTER)
IJ1	INSTRUMENT PANEL WIRE AND FLOOR NO. 1 WIRE (UNDER THE INSTRUMENT PANEL BRACE LH)
IJ2	INSTRUMENT PANEL WIRE AND FLOOR NO. 1 WIRE (UNDER THE INSTRUMENT PANEL BRACE LH)

# ELECTRICAL WIRING ROUTING

**□** : Location of Connector Joining Wire Harness and Wire Harness

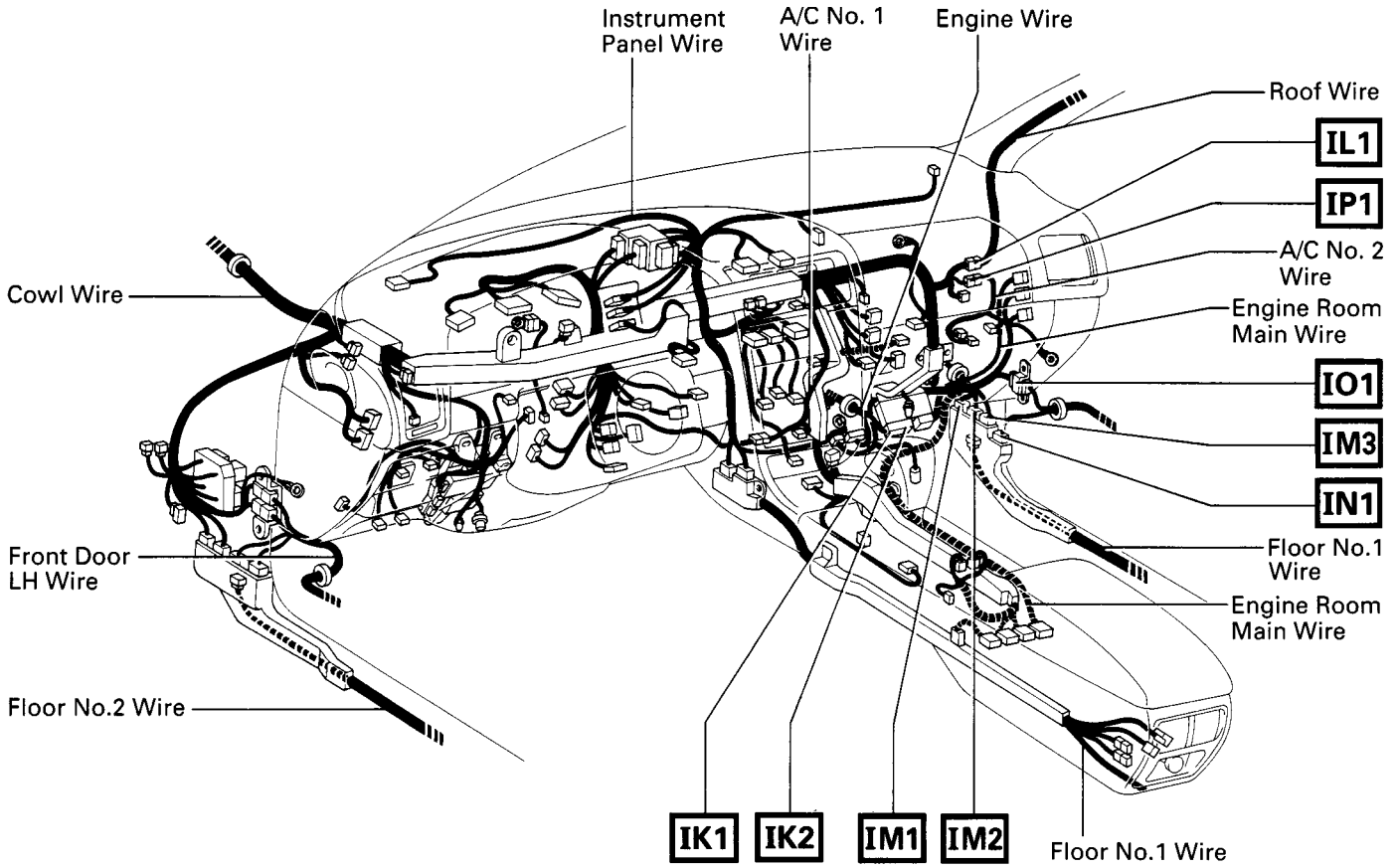

**○** : Location of Splice Points

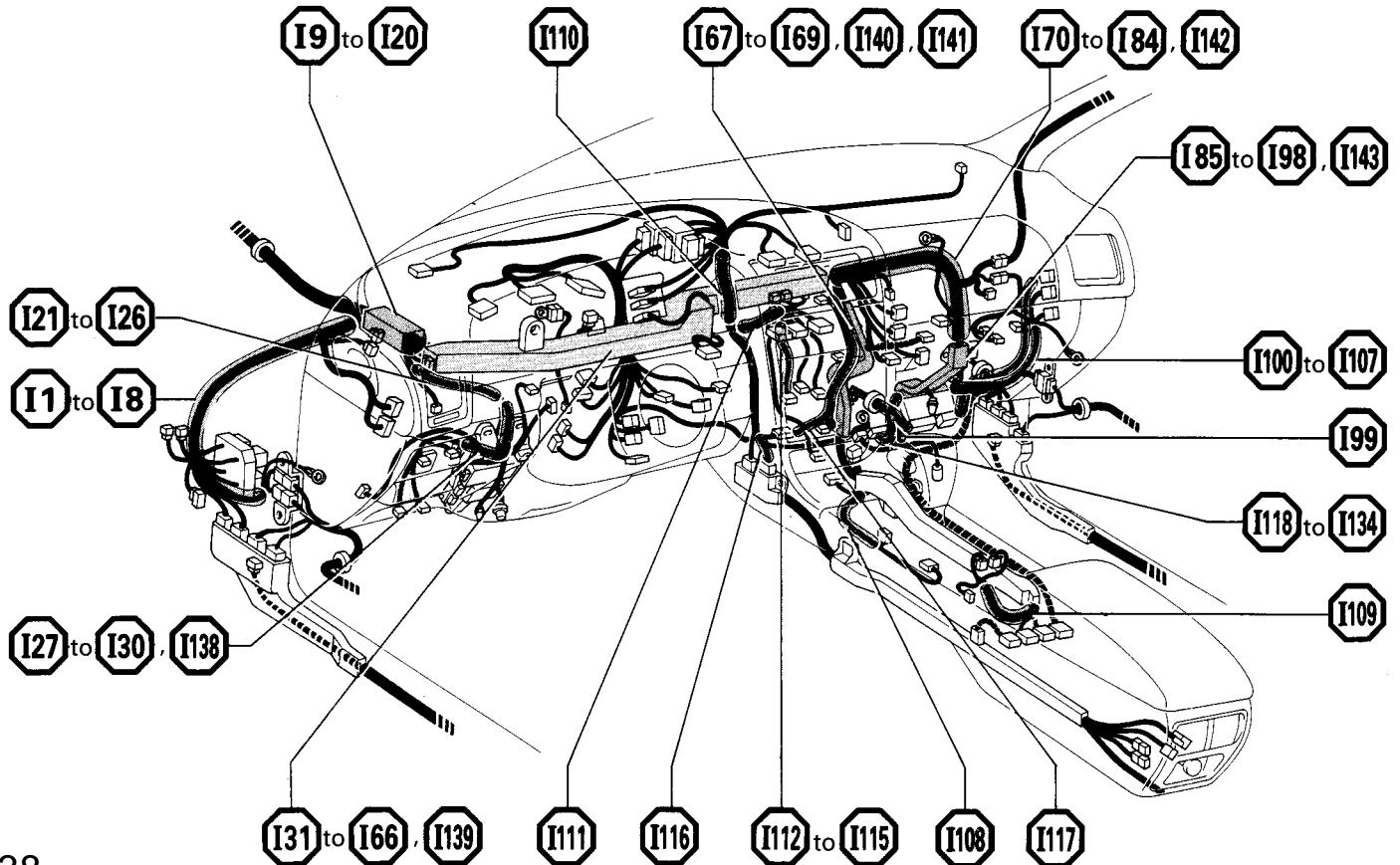

# Connector Joining Wire Harness and Wire Harness

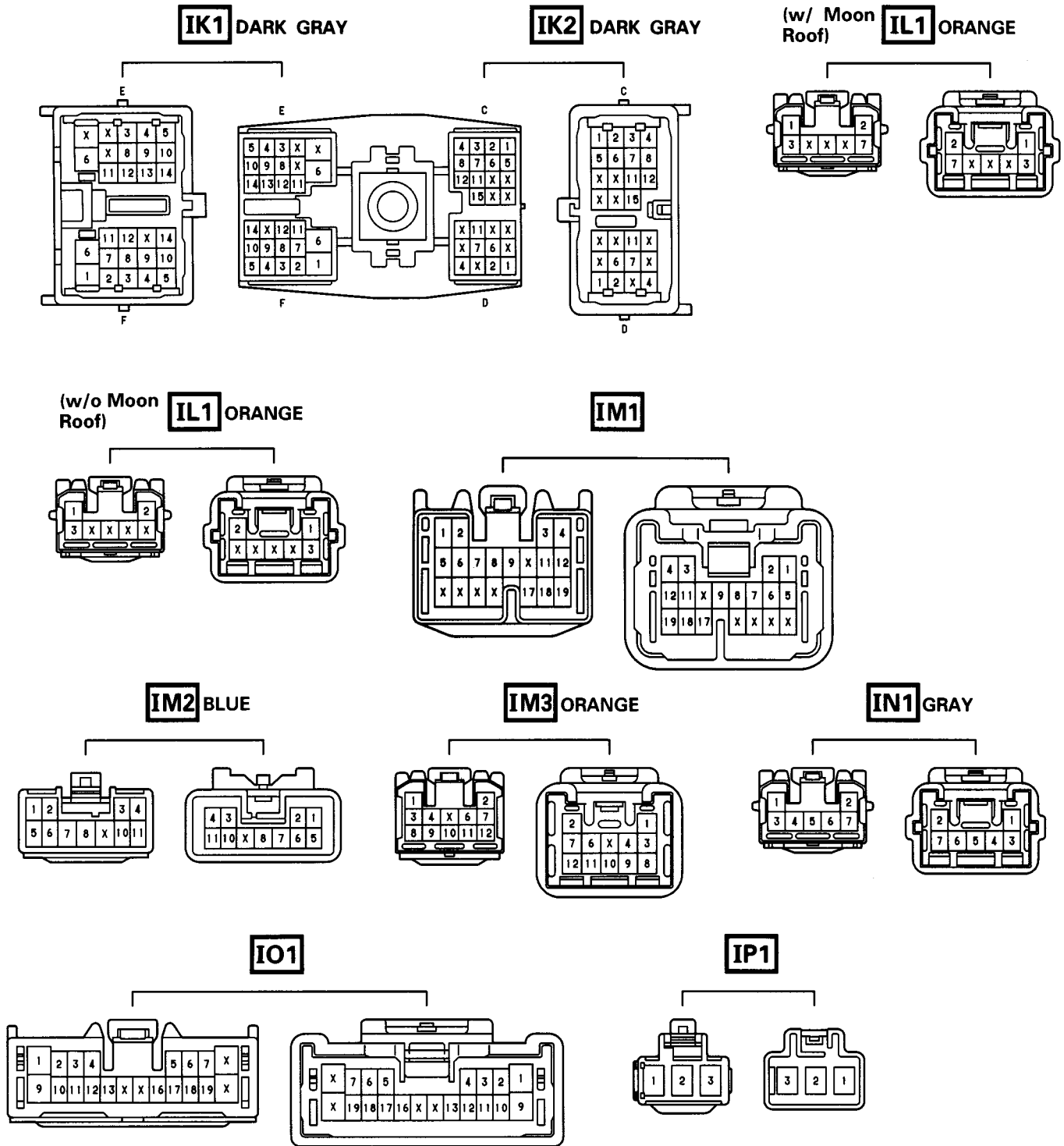

CODE	JOINING WIRE HARNESS AND WIRE HARNESS (CONNECTOR LOCATION)
IK1	ENGINE WIRE AND COWL WIRE (UNDER THE GLOVE BOX)
IK2	COWL WIRE AND ROOF WIRE (BEHIND GLOVE BOX)
IL1	COWL WIRE AND FLOOR NO. 1 WIRE (RIGHT KICK PANEL)
IM1	FRONT DOOR RH WIRE AND FLOOR NO. 1 WIRE (RIGHT KICK PANEL)
IM2	FRONT DOOR RH WIRE AND COWL WIRE (RIGHT KICK PANEL)
IM3	COWL WIRE AND A/C SUB NO. 2 WIRE (BEHIND GLOVE BOX)
IN1	
IO1	
IP1	

# ELECTRICAL WIRING ROUTING

- : Location of Connector Joining Wire Harness and Wire Harness
- ▽ : Location of Ground Points

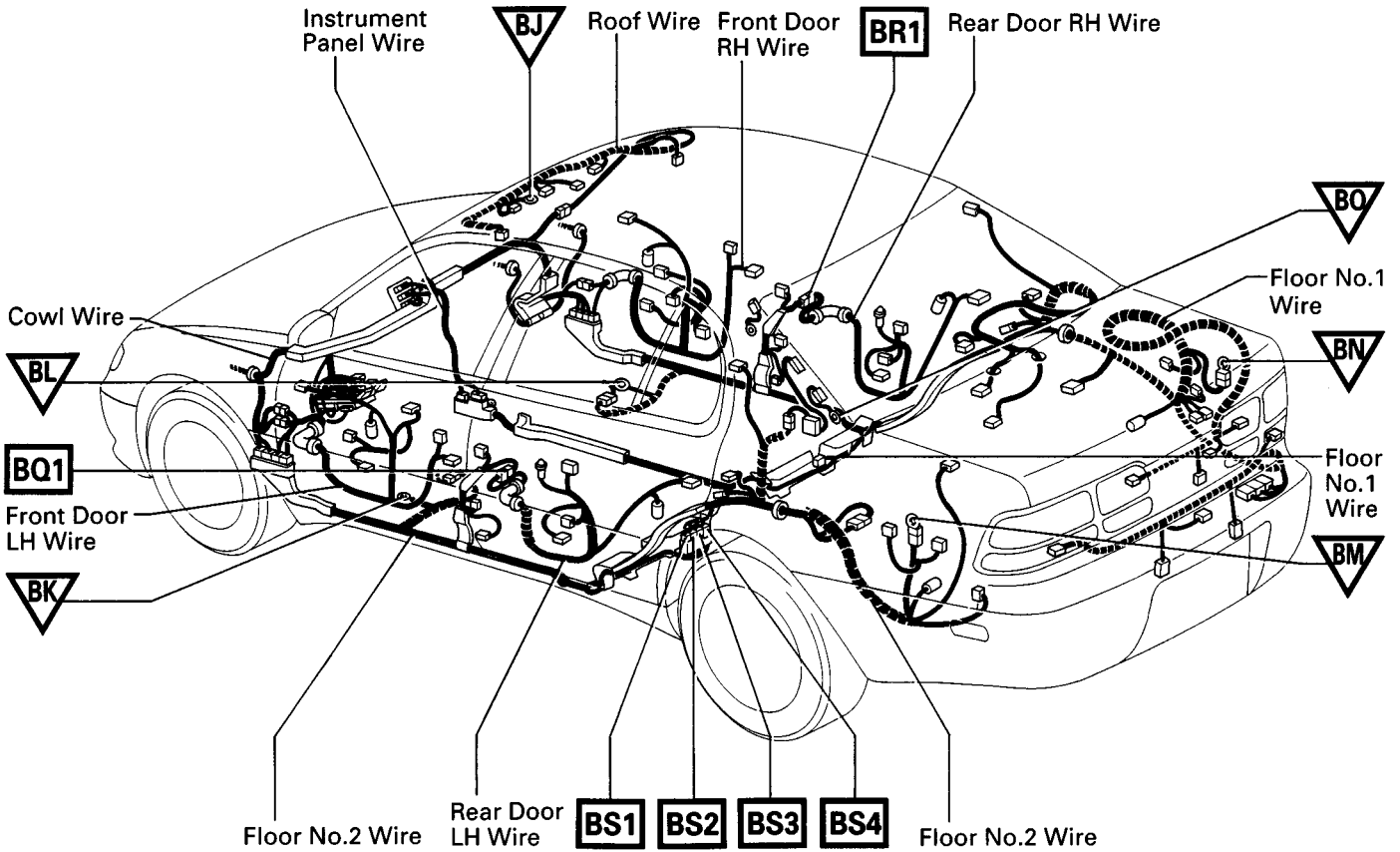

- : Location of Splice Points

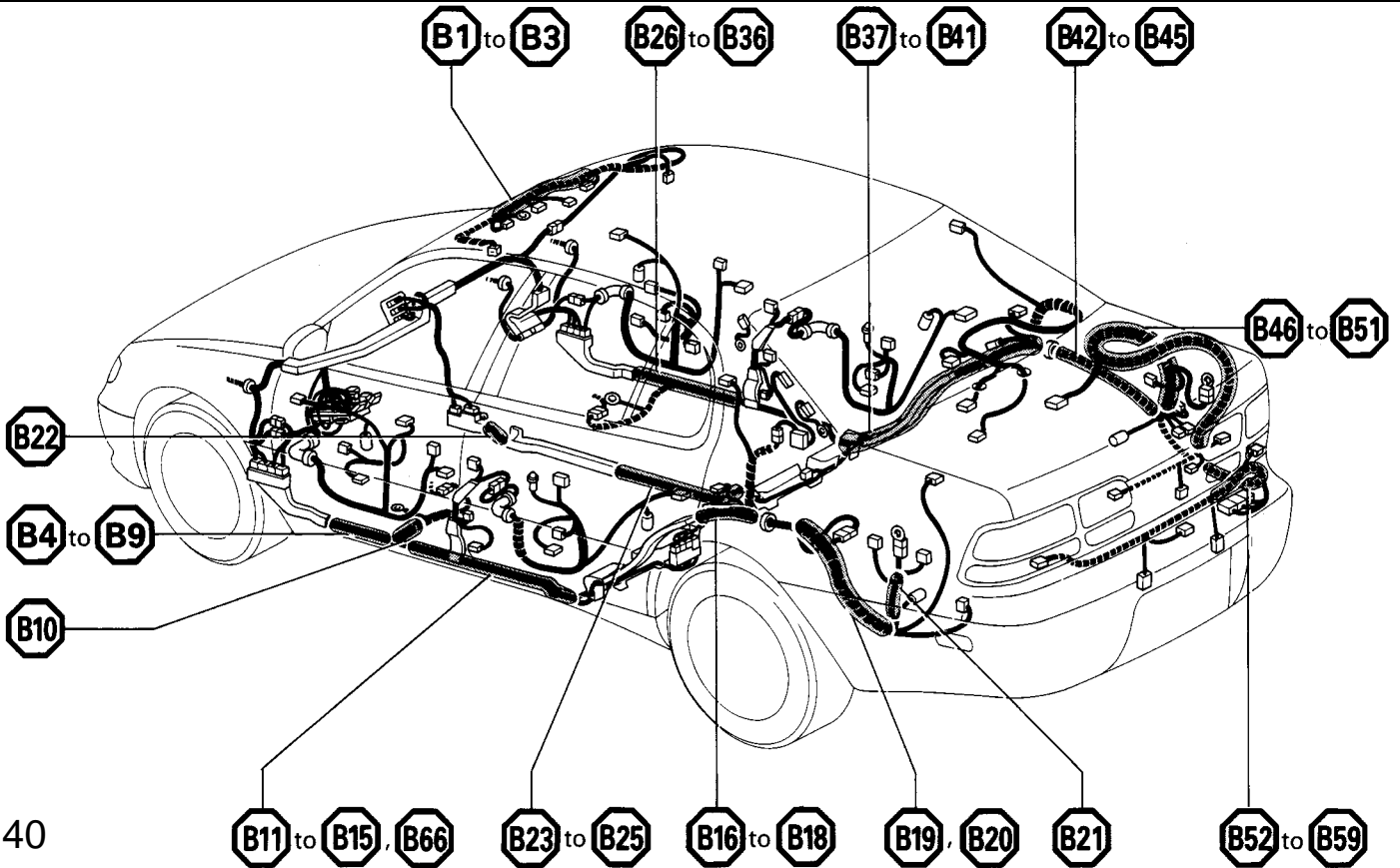

# Connector Joining Wire Harness and Wire Harness

**BQ1** BLUE

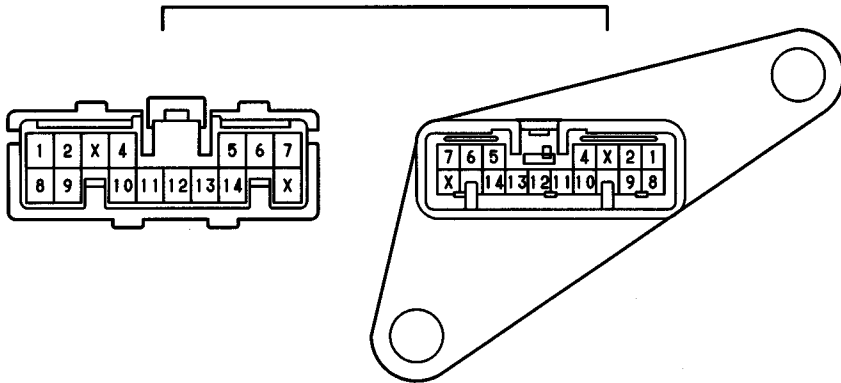

**BR1**

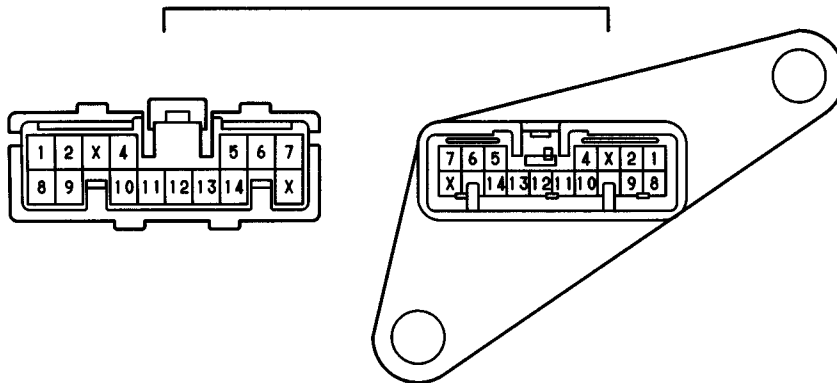

**BS1** BLUE

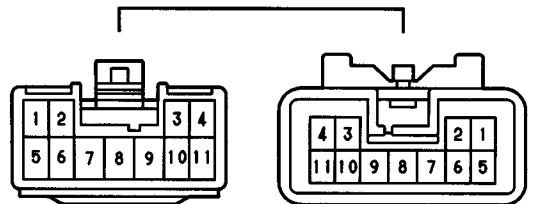

**BS2** ORANGE

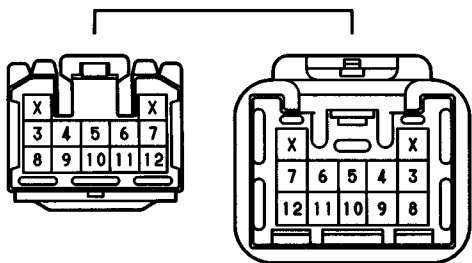

**BS3**

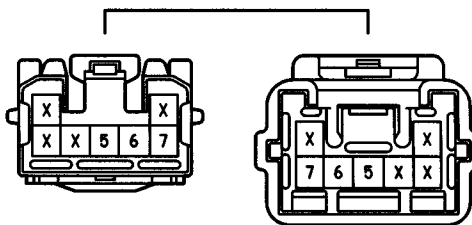

**BS4** YELLOW

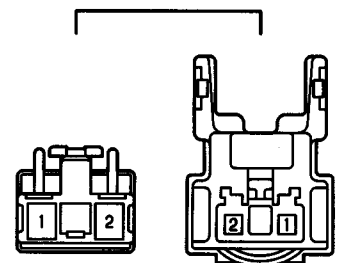

CODE	JOINING WIRE HARNESS AND WIRE HARNESS (CONNECTOR LOCATION)
BQ1	REAR DOOR LH WIRE AND FLOOR NO. 2 WIRE (LEFT CENTER PILLAR)
BR1	REAR DOOR RH WIRE AND FLOOR NO. 1 WIRE (RIGHT CENTER PILLAR)
BS1	FLOOR NO. 1 WIRE AND FLOOR NO. 2 WIRE (UNDER THE LEFT SIDE OF REAR SEAT CUSHION)
BS2	
BS3	
BS4	

# ELECTRICAL WIRING ROUTING

□ : Location of Connector Joining Wire Harness and Wire Harness

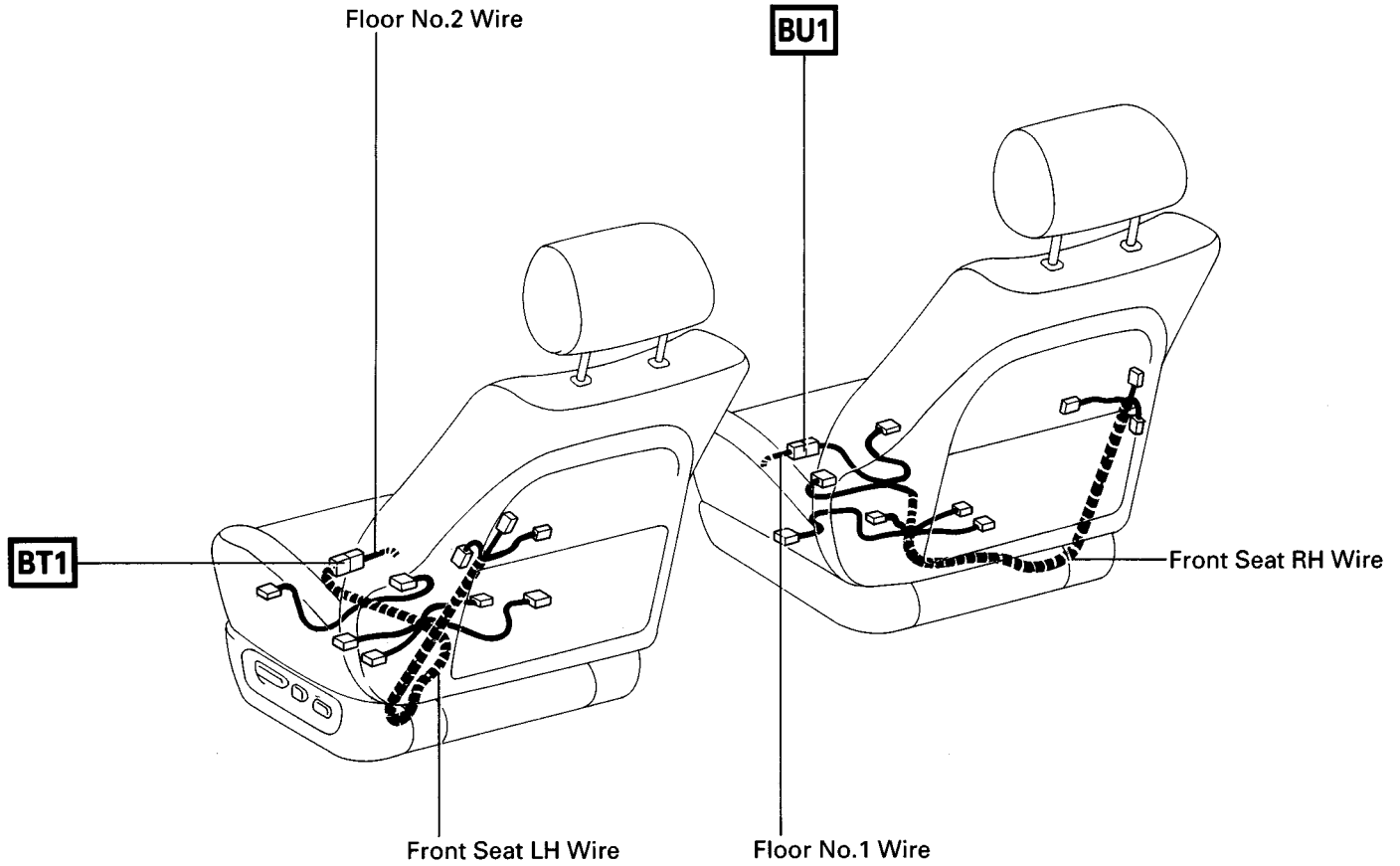

○ : Location of Splice Points

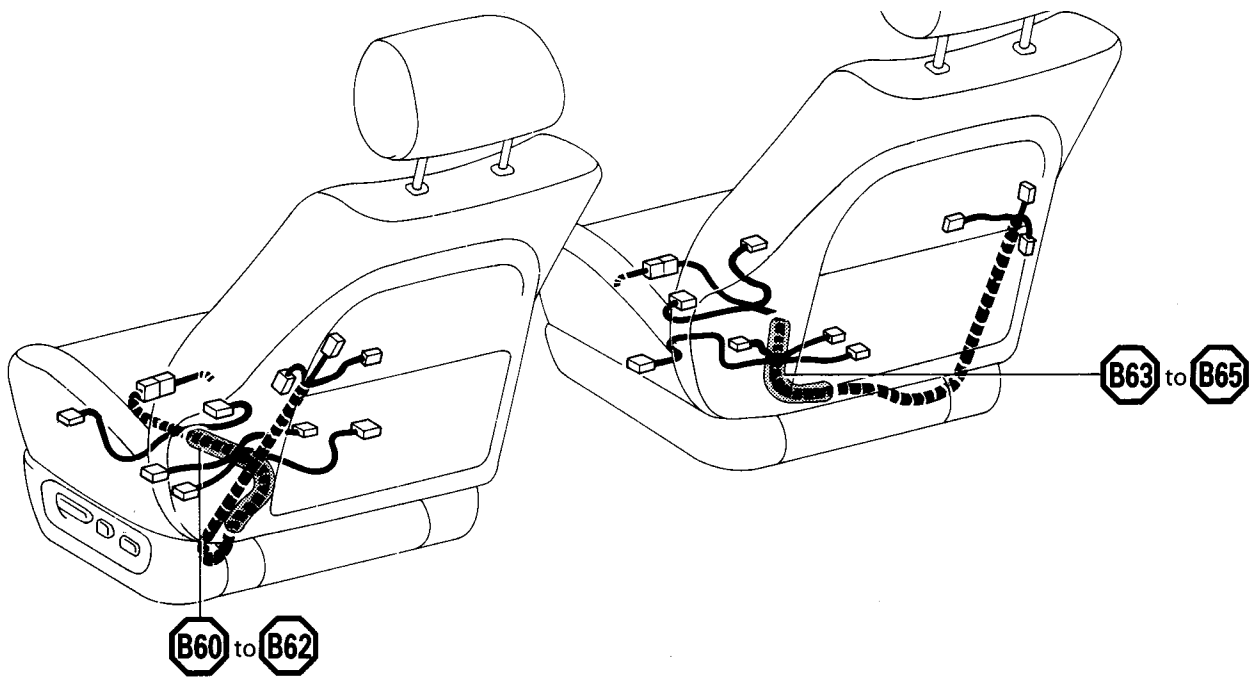



# Connector Joining Wire Harness and Wire Harness

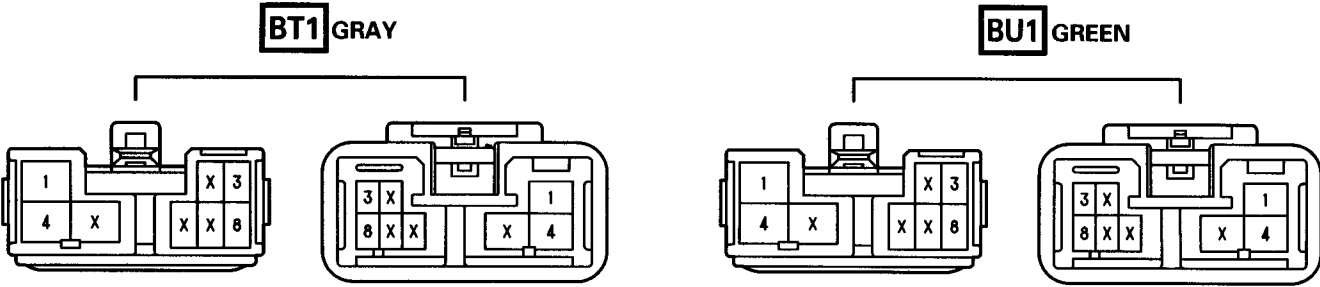

CODE	JOINING WIRE HARNESS AND WIRE HARNESS (CONNECTOR LOCATION)
<b>BT1</b>	FLOOR NO. 2 WIRE AND FRONT SEAT LH WIRE (UNDER THE FRONT LH SEAT)
<b>BU1</b>	FLOOR NO. 1 WIRE AND FRONT SEAT RH WIRE (UNDER THE FRONT RH SEAT)

# POWER SOURCE (Current Flow Chart)

The chart below shows the route by which current flows from the battery to each electrical source (Fusible Link, Circuit Breaker, Fuse, etc.) and other parts.

The next page and following pages show the parts to which each electrical source outputs current.

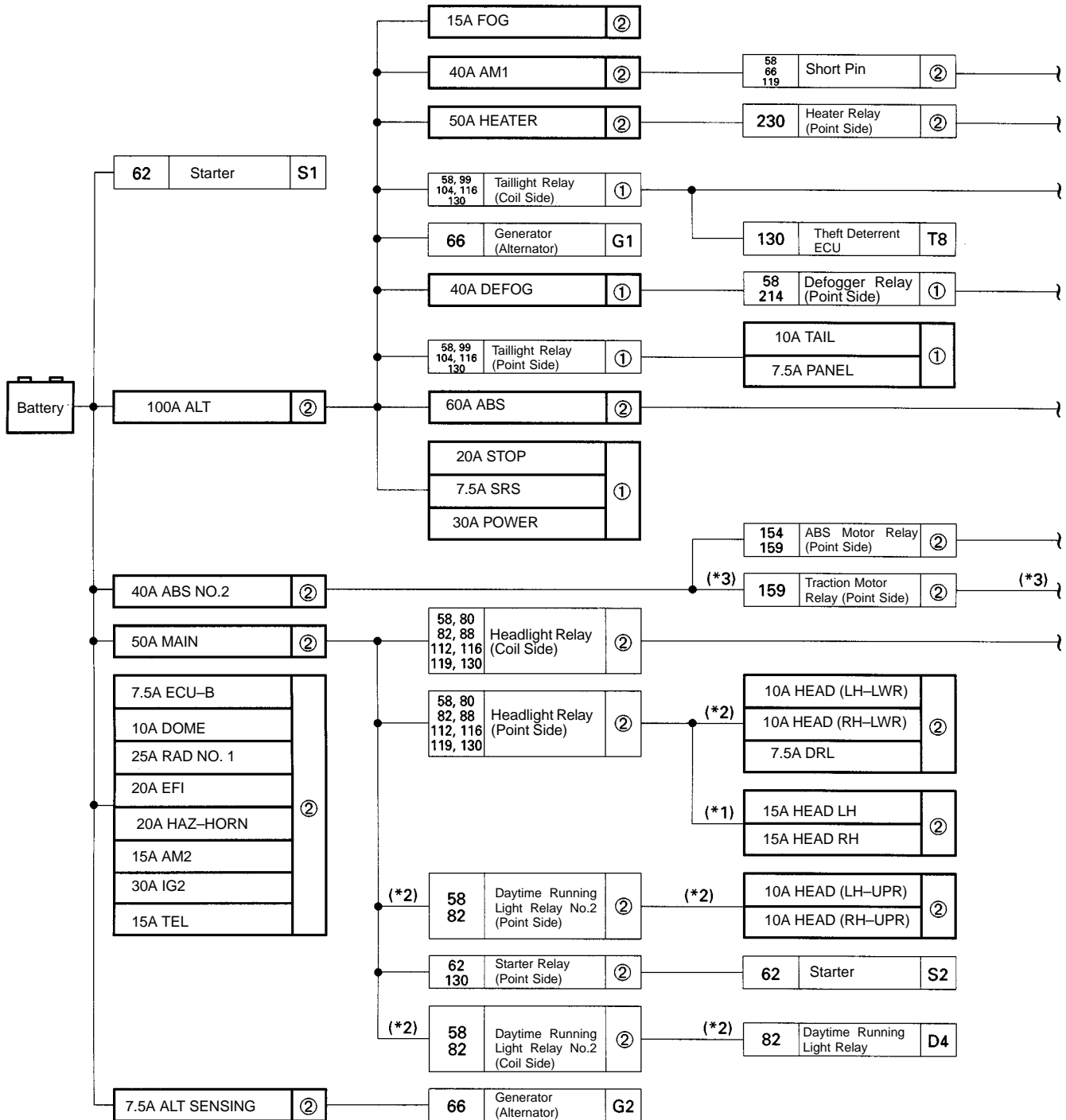

[LOCATION] (1) : J/B No. 1 (See page 20) (2) : R/B No. 2 (See page 19) (3) : J/B No. 6 (See page 24)

- \*1: USA
- \*2: Canada
- \*3: w/ Traction Control
- \*4: w/o Traction Control

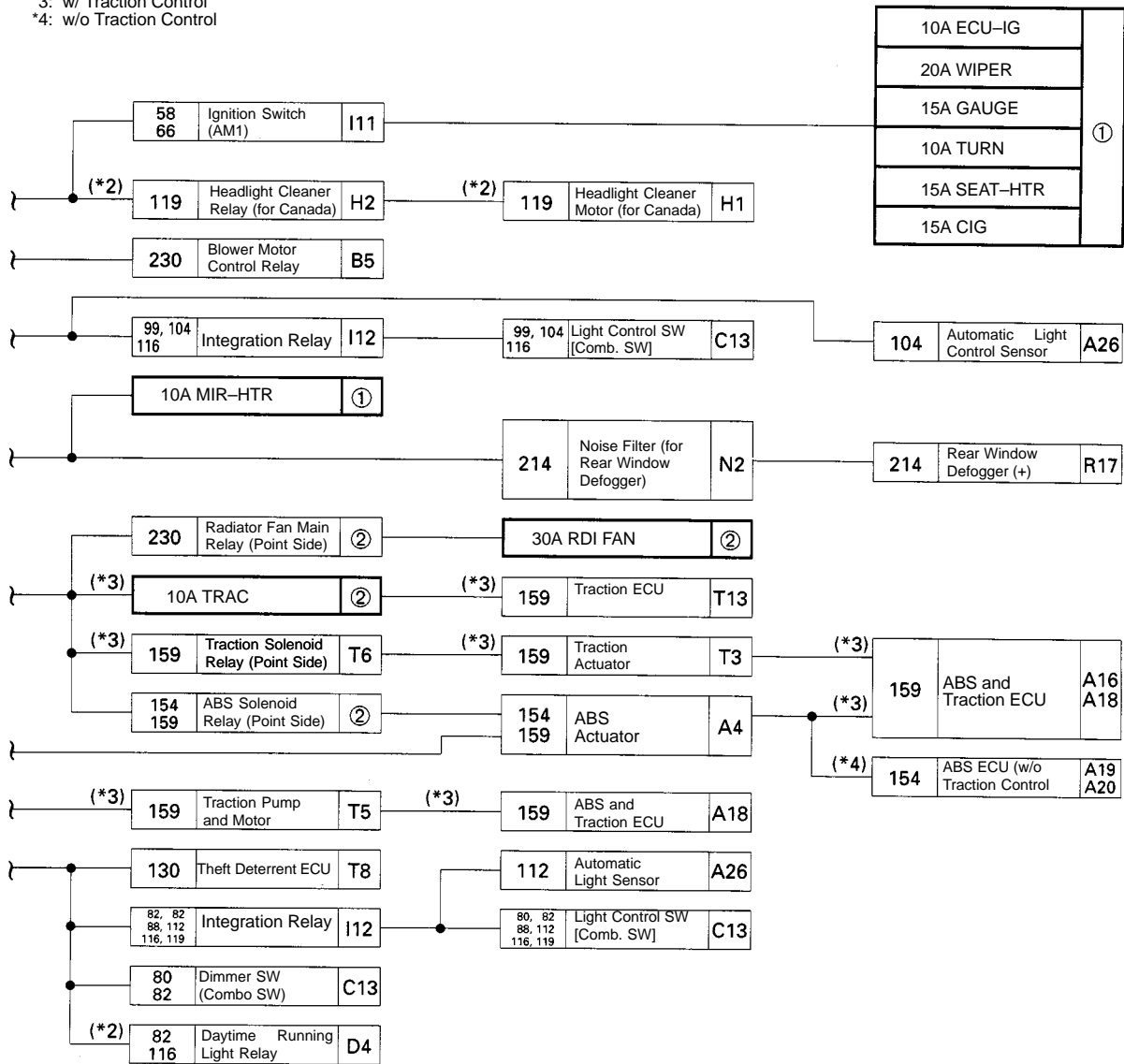

\* These are the page numbers of the first page on which the related system is shown.  
 The part indicated is located somewhere in the system, not necessarily on the page indicated here.

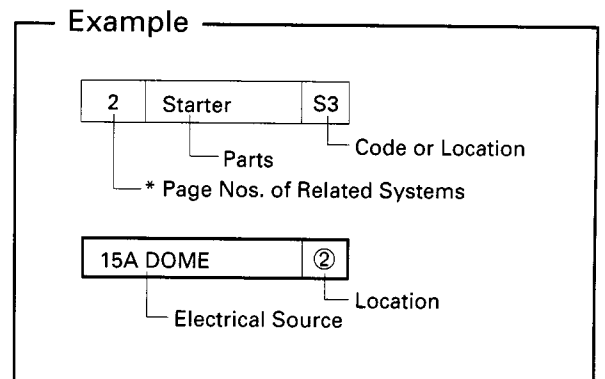

# POWER SOURCE (Current Flow Chart)

Location	*Page Nos. of Related Systems		Parts		Code or Location		CB or Fuse															
	230	230	214 230	99 230	230	99 159 170	159	159	154	112	99	99	216	222	208	208	230	181	181	99 142	99 142	80 170 222
	A/C Single Pressure SW [A/C Triple Pressure SW]	A/C Lock Sensor and A/C Magnetic Clutch	A/C Control Assembly	A/C Control Assembly	A/C Lock Amplifier	A/T Indicator Light (for Shift Lever)	ABS and Traction ECU	ABS and Traction ECU	ABS ECU (w/o Traction Control)	Automatic Light Control Sensor	Ashtray Illumination Rear LH	Ashtray Illumination Rear RH	Auto Antenna Motor and Relay	Brake Fluid Level Warning SW	Buckle SW LH	Buckle SW RH	Condenser Fan Motor	Center Airbag Sensor Assembly	Center Airbag Sensor Assembly	Cigarette Lighter	Clock	Combination Meter
	A2	A3	A8	A10	A12	A15	A16	A18	A20	A26	A29	A30	A31	B1	B6	B7	C1	C3	C5	C7	C8	C9
①	15A	CIG		●									●					●	●	●	●	
	10A	ECU-IG	●				●		●	●			●		●	●						●
	20A	WIPER																				
	15A	GAUGE		●	●	●	●		●	●				●								
	10A	TURN																				
	15A	SEAT-HTR																				
	10A	TAIL																				
	7.5A	PANEL				●	●					●	●								●	●
	20A	STOP							●	●												
	7.5A	SRS																		●		
	30A	POWER																				
	10A	MIR-HTR																				
	②	7.5A	ECU-B		●			●		●				●								●
10A		DOME								●			●									●
25A		RAD NO. 1																				
20A		EFI																				
20A		HAZ-HORN																				
15A		AM2																	●	●		
30A		IG2																				
15A		TEL																				
15A		FOG																				
30A		CDS																				
10A		HEAD (LH-UPR)																				
10A		HEAD (RH-UPR)																				
10A		HEAD (LH-LWR)																				
10A		HEAD (RH-LWR)																				
7.5A		DRL																				
15A		HEAD LH																				
15A		HEAD RH																				
30A	RDI FAN															●					●	

\* These are the page numbers of the first page on which the related system is shown.  
The part indicated is located somewhere in the system, not necessarily on the page indicated here.

[LOCATION] (1) : J/B No. 1 (See page 20) (2) : J/B No. 2 (See page 19) (3) : J/B No. 6 (See page 24)

82	90	154	68 148 159 170 178 222	99 130	104 108	199	66	170 222	99	181	90	210	80 88	88	115	119	210	119	148	94	94	68 154 159 181	68 159 181	148 170	82 119 222	119	68
High Beam Indicator Light [Comb. Meter]	Turn Signal Indicator Light [Comb. Meter]	ABS Warning Light [Comb. Meter]	Combination Meter	Open Door Warning Light [Comb. Meter]	Rear Light Warning Light [Comb. Meter]	Seat Belt Warning Light [Comb. Meter]	Charge Warning Light [Comb. Meter]	Combination Meter	Tailight Indicator [Comb. Meter]	SRS Warning Light [Comb. Meter]	Turn Signal SW [Comb. Meter]	Wiper and Washer SW [Comb. SW]	Dimmer SW [Comb. SW]	Fog Light SW [Comb. SW]	Horn SW [Comb. SW]	Light Control SW [Comb. SW]	Wiper and Washer SW [Comb. SW]	Headlight Cleaner SW [Comb. SW]	Cruise Control ECU	Condenser LH	Condenser RH	Data Link Connector 1 (Check Connector)	Data Link Connector 2 (TDLC)	Daytime Running Light Relay	Diode (for Headlight Cleaner) (for Canada)	Diode (for Idle-Up)	
C9	C10						C11						C12	C13			C14	C15	C18	C19	D1	D3		D4	D5	D6	
•	•	•	•	•	•	•	•	•	•	•	•	•	•	•	•	•	•	•	•	•	•	•	•	•	•	•	•

# POWER SOURCE (Current Flow Chart)

Location	*Page Nos. of Related Systems																			
	Parts																			
	Code or Location																			
CB or Fuse		D7	D8	D9	D10	D11	D12	D13	D14	D15	D18	D23	D24	E2	E5	E6	E7	E8	F1	F2
①	15A	CIG																		
	10A	ECU-IG									●					●	●			
	20A	WIPER																		
	15A	GAUGE	●												●		●			
	10A	TURN																		
	15A	SEAT-HTR																		
	10A	TAIL																		
	7.5A	PANEL														●	●			
	20A	STOP																		
	7.5A	SRS																		
	30A	POWER																		
	10A	MIR-HTR																●		
	②	7.5A	ECU-B																	
10A		DOME		●	●	●	●	●	●	●		●	●							
25A		RAD NO. 1																		
20A		EFI												●			●	●		
20A		HAZ-HORN																		
15A		AM2															●	●		
30A		IG2																●		
15A		TEL																		
15A		FOG																	●	●
30A		CDS																		
10A		HEAD (LH-UPR)																		
10A		HEAD (RH-UPR)																		
10A		HEAD (LH-LWR)																		
10A		HEAD (RH-LWR)																		
7.5A		DRL																		
15A		HEAD LH																		
15A		HEAD RH																		
30A	RDI FAN																			

\* These are the page numbers of the first page on which the related system is shown.  
The part indicated is located somewhere in the system, not necessarily on the page indicated here.

[LOCATION] (1) : J/B No. 1 (See page 20) (2) : J/B No. 2 (See page 19) (3) : J/B No. 6 (See page 24)



# POWER SOURCE (Current Flow Chart)

Location	*Page Nos. of Related Systems		Parts	Code or Location	CB or Fuse	58 66 130 170 222	62 68 148 181	119	104	104	104 108	94 130	94 130	68	68	144	194	194	230	62	222	170	62 111 159 187	68 130 170 222	178
	Ignition SW, Unlock Warning SW and Key Interlock Solenoid	Integration Relay																							
						I11	I12	L2	L3	L4	L7	L8	M1	M2	M5	M7	M9	M10	N1	O2	O3	P1	P3		
①	15A	CIG																							
	10A	ECU-IG													●									●	
	20A	WIPER					●																		
	15A	GAUGE								●								●		●	●		●		
	10A	TURN																							
	15A	SEAT-HTR																							
	10A	TAIL						●	●	●															
	7.5A	PANEL																							
	20A	STOP									●														
	7.5A	SRS																							
	30A	POWER															●	●							
	10A	MIR-HTR																							
②	7.5A	ECU-B																							
	10A	DOME									●	●					●								
	25A	RAD NO. 1																							
	20A	EFI											●	●											
	20A	HAZ-HORN																							
	15A	AM2					●																●		
	30A	IG2																					●		
	15A	TEL																							
	15A	FOG																							
	30A	CDS																							
	10A	HEAD (LH-UPR)																							
	10A	HEAD (RH-UPR)																							
	10A	HEAD (LH-LWR)																							
	10A	HEAD (RH-LWR)																							
	7.5A	DRL																							
	15A	HEAD LH																							
	15A	HEAD RH																							
	30A	RDI FAN																							

\* These are the page numbers of the first page on which the related system is shown.  
The part indicated is located somewhere in the system, not necessarily on the page indicated here.

[LOCATION] (1) : J/B No. 1 (See page 20) (2) : J/B No. 2 (See page 19) (3) : J/B No. 6 (See page 24)





# POWER SOURCE (Current Flow Chart)

Location	*Page Nos. of Related Systems		Parts		Code or Location		CB or Fuse																
	108	104	111	108	104	90	108	104	111	108	104	94	94	122 214	122 214	99 206	192	94	94	108 148 154 159 192	68	218	
	R9		R10		R11		R12		R15	R16	R19	R20	S5	S6	S7	S8	S9	S10	S14				
①	15A	CIG																					
	10A	ECU-IG																					
	20A	WIPER																					
	15A	GAUGE																					
	10A	TURN																					
	15A	SEAT-HTR																					
	10A	TAIL																					
	7.5A	PANEL																					
	20A	STOP																					
	7.5A	SRS																					
	30A	POWER																					
	10A	MIR-HTR																					
②	7.5A	ECU-B																					
	10A	DOME																					
	25A	RAD NO. 1																					
	20A	EFI																					
	20A	HAZ-HORN																					
	15A	AM2																					
	30A	IG2																					
	15A	TEL																					
	15A	FOG																					
	30A	CDS																					
	10A	HEAD (LH-UPR)																					
	10A	HEAD (RH-UPR)																					
	10A	HEAD (LH-LWR)																					
	10A	HEAD (RH-LWR)																					
	7.5A	DRL																					
	15A	HEAD LH																					
	15A	HEAD RH.																					
	30A	RDI FAN																					

\* These are the page numbers of the first page on which the related system is shown.  
The part indicated is located somewhere in the system, not necessarily on the page indicated here.

[LOCATION] (1) : J/B No. 1 (See page 20) (2) : J/B No. 2 (See page 19) (3) : J/B No. 6 (See page 24)

206	206	206	206	130	124	130	138	194	187	187	187	159	159	144	208	208	68	68	68	68	94	94	222	210	222	230	210	210
Seat Heater (for Driver's Seat Back)	Seat Heater (for Driver's Seat Cushion)	Seat Heater (for Passenger's Seat Back)	Seat Heater (for Passenger's Seat Cushion)	Theft Deterrent Horn	Theft Deterrent ECU	Theft Deterrent ECU	Theft Deterrent ECU	Tilt and Power Telescopic ECU	Tilt and Power Telescopic ECU	Tilt and Power Telescopic ECU	Traction ECU	Traction ECU	Telephone Transceiver and Speaker Relay	Tension Reducer Solenoid LH	Tension Reducer Solenoid RH	Vehicle Speed Sensor (Speed Sensor) No.1 (for Combination Meter)	VSV (for EGR)	VSV (for EVAP)	VSV (for Fuel Pressure Up)	VSV (for Intake Control)	Vanity Light LH	Vanity Light RH	Washer Level Warning SW	Washer Motor	Water Temp. Sender	Water Temp. SW	Wiper Angle Control Motor	Wiper Motor
S17	S18	S19	S20	T1	T7	T8	T9	T10	T11	T13	T14	T16	T17	T18	V1	V4	V5	V6	V7	V8	V9	W1	W2	W3	W4	W5	W6	
					•	•		•		•		•	•	•									•	•		•	•	
•	•	•	•												•													
					•		•		•												•							
						•		•																				
						•		•																				

# POWER SOURCE (Current Flow Chart)

Location	*Page Nos. of Related Systems		Parts		Code or Location		CB or Fuse																
	210	138	138	214	94 116 199	230	154 159	82 222	82 222	68 170	230	115 130	62 68	62 68	230	230	230	62 130	82	82	88	88	
	Wiper Relay	Wireless Door Lock Main SW	Wireless Door Lock ECU	Defogger Relay (Coil Side)	Integration Relay	A/C Magnetic Clutch Relay	ABS Solenoid Relay	Daytime Running Light Relay No. 3 (Coil Side)	Daytime Running Light Relay No. 3 (Point Side)	EFI Main Relay (Point Side)	Heater Relay (Coil Side)	Horn Relay	IG2 Relay (Coil Side)	IG2 Relay (Point Side)	Radiator Fan Main Relay (Coil Side)	Radiator Fan Relay (Coil Side)	Radiator Fan Relay (Point Side)	Starter Relay (Coil Side)	Daytime Running Light Relay No. 4 (Coil Side)	Daytime Running Light Relay No. 4 (Point Side)	Fog Light Relay (Coil Side)	Fog Light Relay (Point Side)	
	W8	W9	W10	①	②										③								
①	15A	CIG			●																		
	10A	ECU-IG		●											●	●							
	20A	WIPER	●																				
	15A	GAUGE			●	●	●	●			●												
	10A	TURN																					
	15A	SEAT-HTR																					
	10A	TAIL																					
	7.5A	PANEL																					
	20A	STOP																					
	7.5A	SRS																					
	30A	POWER																					
	10A	MIR-HTR																					
②	7.5A	ECU-B																					
	10A	DOME	●	●	●																		
	25A	RAD NO. 1								●													
	20A	EFI									●												
	20A	HAZ-HORN										●											
	15A	AM2										●	●					●					
	30A	IG2											●										
	15A	TEL																					
	15A	FOG																					●
	30A	CDS																					
	10A	HEAD (LH-UPR)								●											●		
	10A	HEAD (RH-UPR)								●											●		
	10A	HEAD (LH-LWR)																				●	
	10A	HEAD (RH-LWR)																				●	
	7.5A	DRL							●														
	15A	HEAD LH																					●
	15A	HEAD RH																					
	30A	RDI FAN														●							

\* These are the page numbers of the first page on which the related system is shown.  
The part indicated is located somewhere in the system, not necessarily on the page indicated here.

[LOCATION] (1) : J/B No. 1 (See page 20) (2) : J/B No. 2 (See page 19) (3) : J/B No. 6 (See page 24)

124 130 194	Power Main Relay (Coil Side)
124 130 194	Power Main Relay (Point Side)
90	Turn Signal Flasher
③	
●	
	●
●	●
●	
	●

# POWER SOURCE

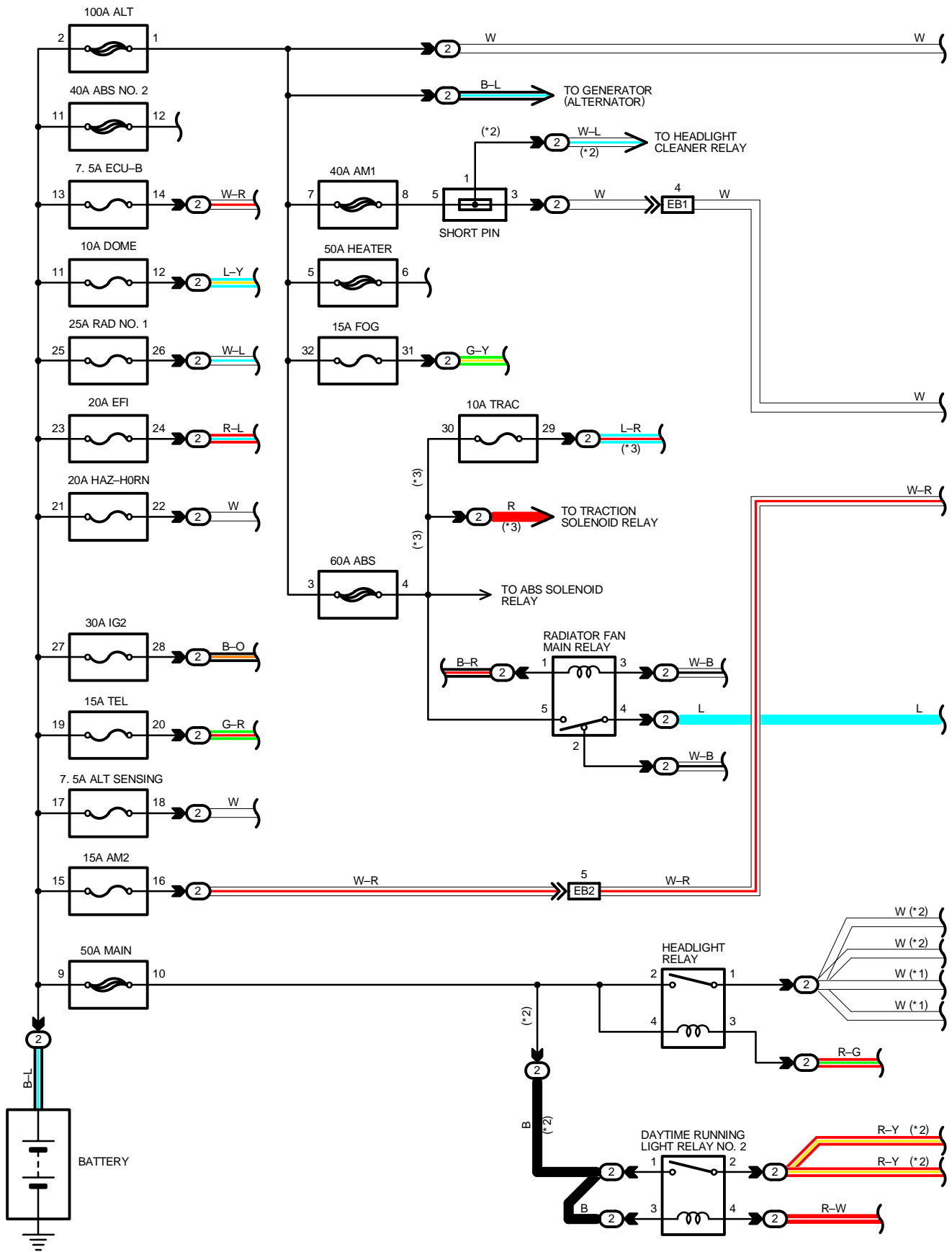

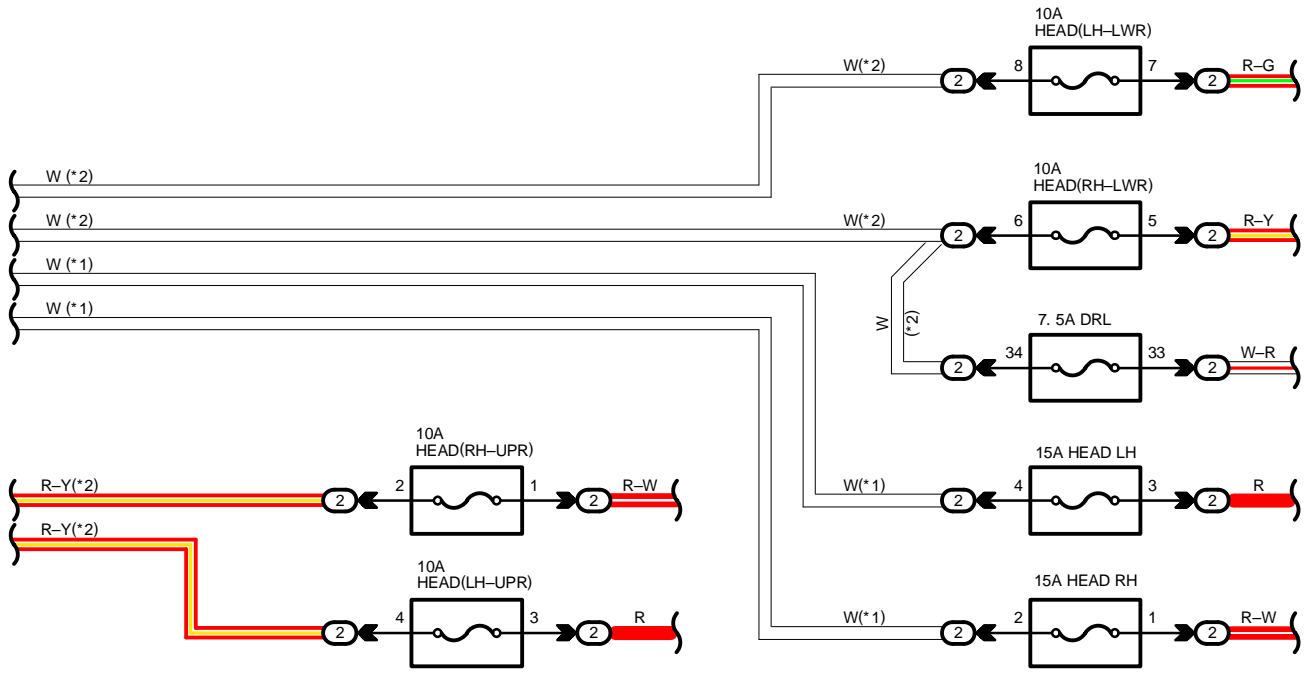
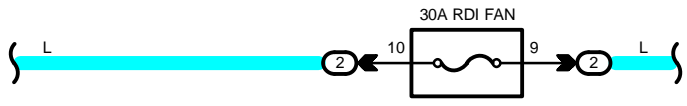
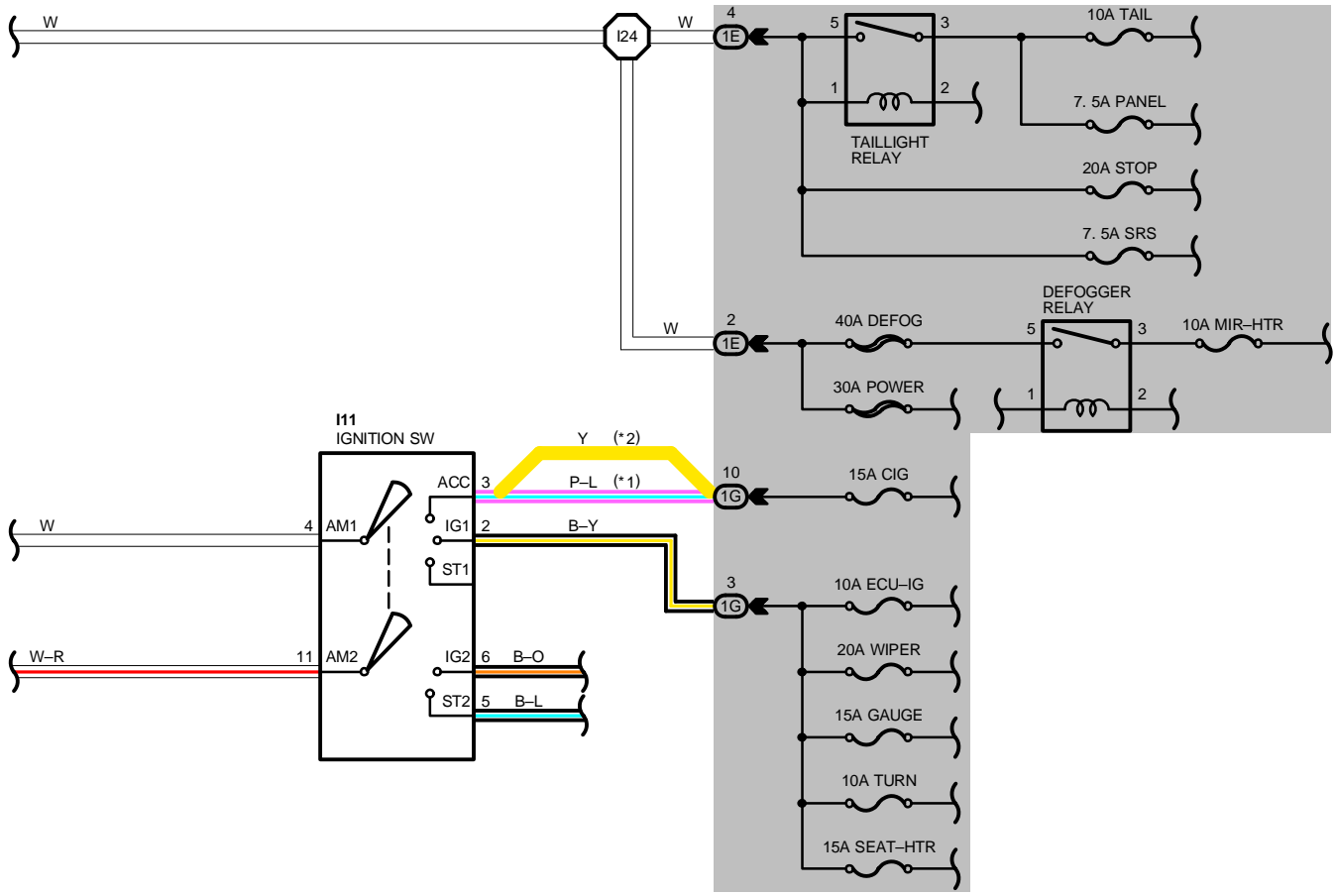

# POWER SOURCE

## SERVICE HINTS

### HEADLIGHT RELAY (FOR USA)

(2) 2- (2) 1: CLOSED WITH LIGHT CONTROL SW AT **HEAD** POSITION OR DIMMER SW AT **FLASH** POSITION

### HEADLIGHT RELAY (FOR CANADA)

(2) 2- (2) 1: CLOSED WITH LIGHT CONTROL SW AT **HEAD** POSITION OR DIMMER SW AT **FLASH** POSITION

: CLOSE WITH ENGINE RUNNING AND PARKING BRAKE PEDAL RELEASED (PARKING BRAKE SW OFF)

### TAILLIGHT RELAY

5-3 : CLOSED WITH LIGHT CONTROL SW AT **TAIL** OR **HEAD** POSITION

### I11 IGNITION SW

4-3 : CLOSED WITH IGNITION KEY AT **ACC** OR **ON** POSITION

4-2 : CLOSED WITH IGNITION KEY AT **ON** OR **ST** POSITION

11-6: CLOSED WITH IGNITION KEY AT **ON** OR **ST** POSITION

11-5: CLOSED WITH IGNITION KEY AT **ST** POSITION

## ○ : PARTS LOCATION

CODE	SEE PAGE	CODE	SEE PAGE	CODE	SEE PAGE
I11	29				

## ○ : RELAY BLOCKS

CODE	SEE PAGE	RELAY BLOCKS (RELAY BLOCK LOCATION)
2	19	R/B NO. 2 (ENGINE COMPARTMENT LEFT)

## ○ : JUNCTION BLOCK AND WIRE HARNESS CONNECTOR

CODE	SEE PAGE	JUNCTION BLOCK AND WIRE HARNESS (CONNECTOR LOCATION)
1E IG	20	COWL WIRE AND J/B NO. 1 (LEFT KICK PANEL)

## □ : CONNECTOR JOINING WIRE HARNESS AND WIRE HARNESS

CODE	SEE PAGE	JOINING WIRE HARNESS AND WIRE HARNESS (CONNECTOR LOCATION)
EB1 EB2	34	COWL WIRE AND R/B NO. 2 WIRE (INSIDE OF R/B NO. 2)

## ○ : SPLICE POINTS

CODE	SEE PAGE	WIRE HARNESS WITH SPLICE POINTS	CODE	SEE PAGE	WIRE HARNESS WITH SPLICE POINTS
I24	38	COWL WIRE			

I11 BLACK

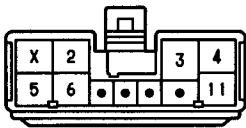



---

# STARTING AND IGNITION

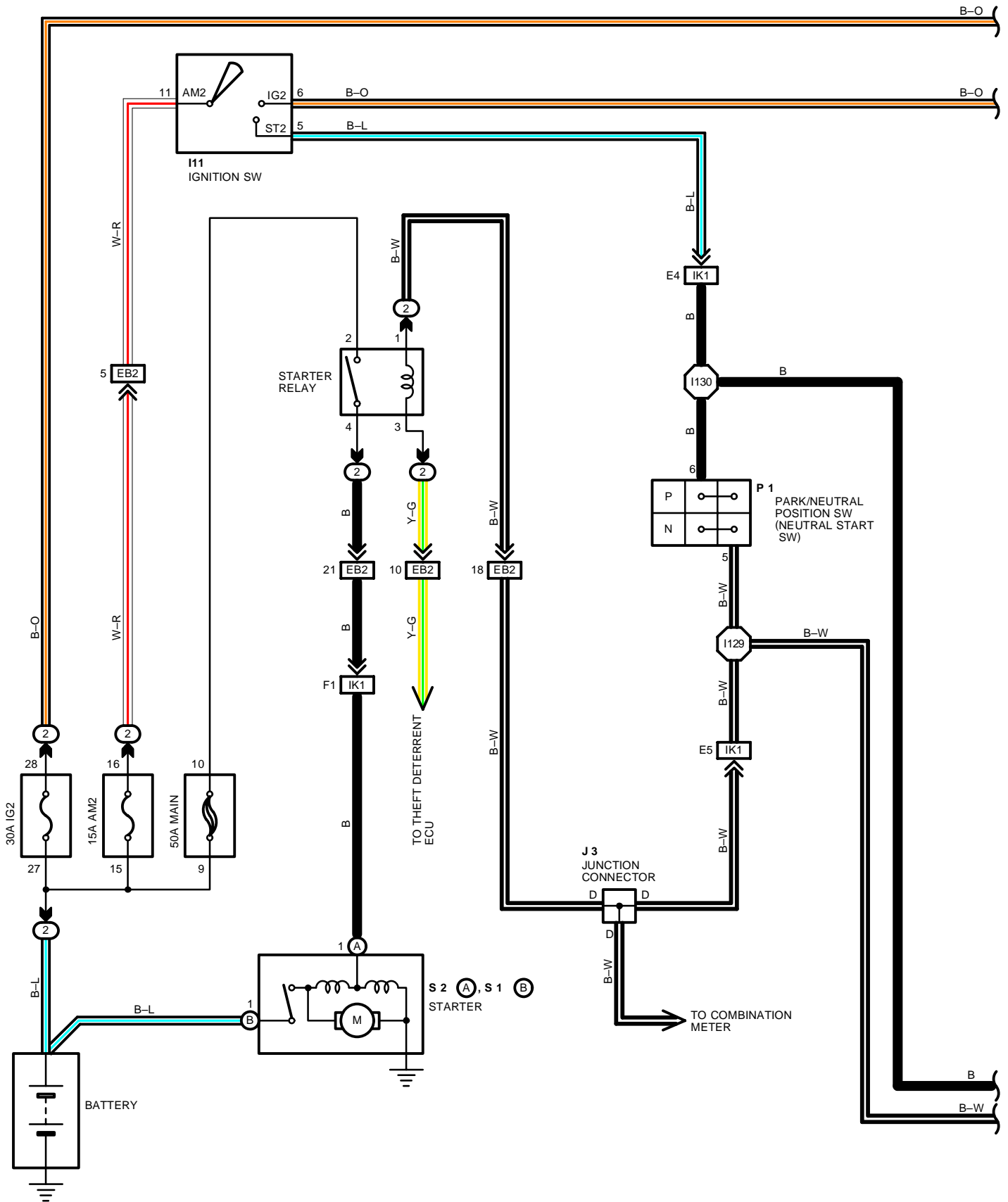

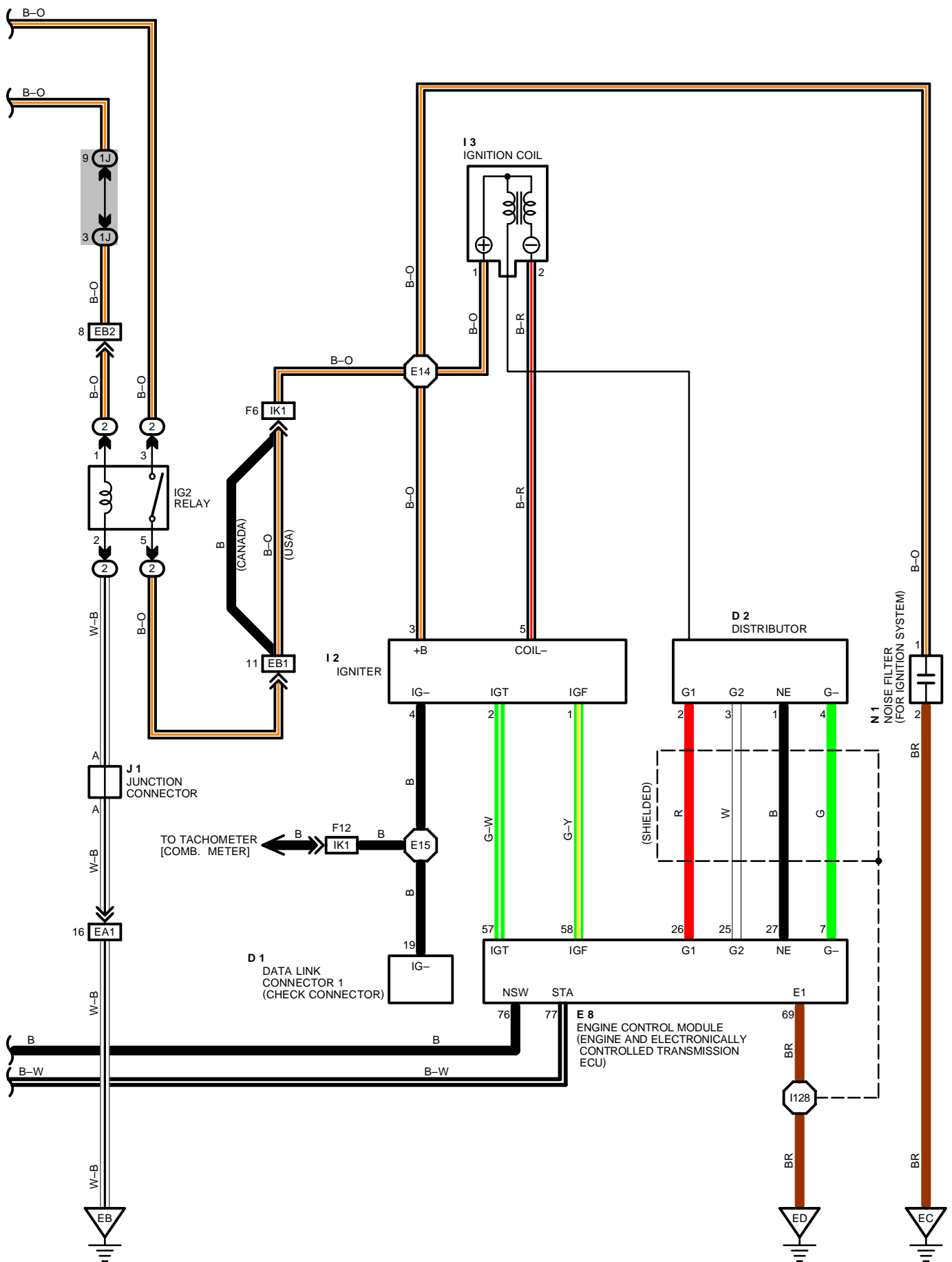

# STARTING AND IGNITION

## SERVICE HINTS

### I11 IGNITION SW

11-6: CLOSED WITH IGNITION SW AT **ON** OR **ST** POSITION

11-5: CLOSED WITH IGNITION SW AT **ST** POSITION

### P 1 PARK/NEUTRAL POSITION SW (NEUTRAL START SW)

6-5 : CLOSED WITH A/T SHIFT LEVER IN **P** OR **N** POSITION

### S 1(B), S 2(A) STARTER

POINTS CLOSED WITH PARK/NEUTRAL POSITION SW (NEUTRAL START SW) ON AND IGNITION SW AT **ST** POSITION

## ○ : PARTS LOCATION

CODE	SEE PAGE	CODE	SEE PAGE	CODE	SEE PAGE
D 1	26	I 3	26	N 1	27
D 2	26	I11	29	P 1	27
E 8	28	J 1	27	S 1	B 27
I 2	26	J 3	29	S 2	A 27

## ○ : RELAY BLOCKS

CODE	SEE PAGE	RELAY BLOCKS (RELAY BLOCK LOCATION)
2	19	R/B NO. 2 (ENGINE COMPARTMENT LEFT)

## ○ : JUNCTION BLOCK AND WIRE HARNESS CONNECTOR

CODE	SEE PAGE	JUNCTION BLOCK AND WIRE HARNESS (CONNECTOR LOCATION)
1J	20	COWL WIRE AND J/B NO. 1 (LEFT KICK PANEL)

## □ : CONNECTOR JOINING WIRE HARNESS AND WIRE HARNESS

CODE	SEE PAGE	JOINING WIRE HARNESS AND WIRE HARNESS (CONNECTOR LOCATION)
EA1	34	ENGINE ROOM MAIN WIRE AND R/B NO. 2 WIRE (INSIDE OF R/B NO. 2)
EB1	34	COWL WIRE AND R/B NO. 2 WIRE (INSIDE OF R/B NO. 2)
EB2		
IK1	38	ENGINE WIRE AND COWL WIRE (UNDER THE GLOVE BOX)

## ▽ : GROUND POINTS

CODE	SEE PAGE	GROUND POINTS LOCATION
EB	34	FRONT SIDE OF LEFT FENDER
EC	34	FRONT SIDE OF INTAKE MANIFOLD
ED	34	REAR SIDE OF INTAKE MANIFOLD

## ○ : SPLICE POINTS

CODE	SEE PAGE	WIRE HARNESS WITH SPLICE POINTS	CODE	SEE PAGE	WIRE HARNESS WITH SPLICE POINTS
E14	34	ENGINE WIRE	I129	38	ENGINE WIRE
E15			I130		
I128			38		

D 1 BLACK

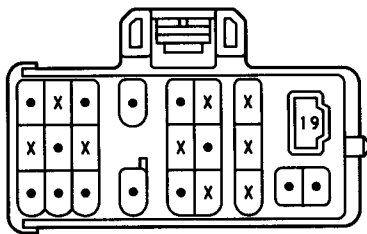

D 2 BLACK

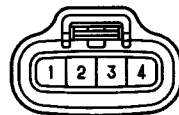

E 8 DARK GRAY

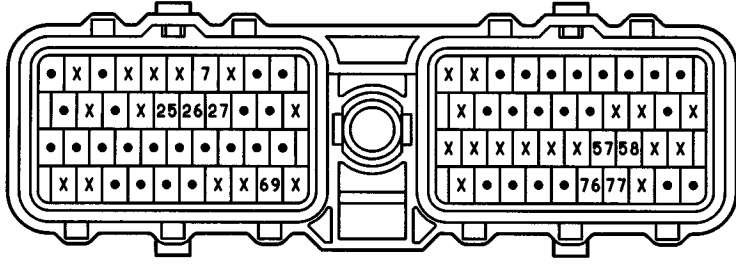

I 2 BLACK

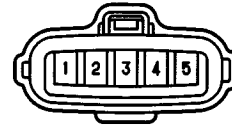

I 3 BLACK



I 11 BLACK

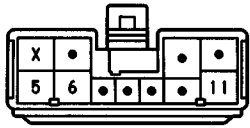

J 1



(HINT:SEE PAGE 7)

J 3 BLACK

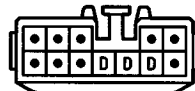

(HINT:SEE PAGE 7)

N 1 BLACK



P 1 GRAY

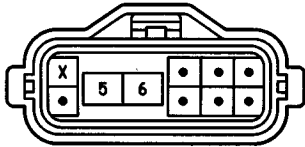

S 1 B



S 2 A BLACK



# CHARGING

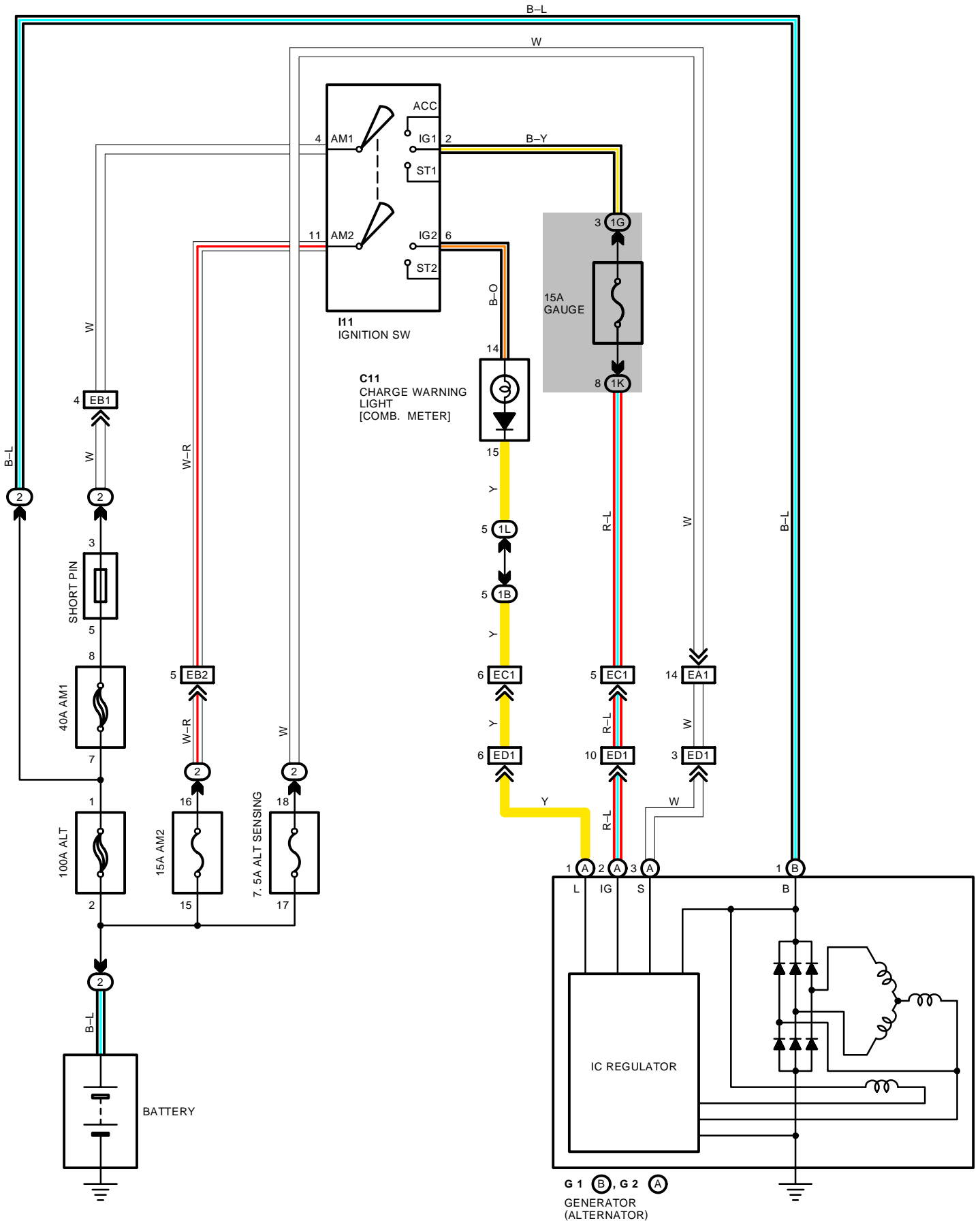

**SERVICE HINTS**

**G 2 (A) GENERATOR (ALTERNATOR)**

- (A) 1-GROUND: 13.9–15.1 VOLTS WITH ENGINE RUNNING AT 2000 RPM AND 25°C (77°F)  
13.5–14.3 VOLTS WITH ENGINE RUNNING AT 5000 RPM AND 115°C (239°F)
- (A) 2-GROUND: 0–4 VOLTS WITH IGNITION SW AT ON POSITION AND ENGINE NOT RUNNING

**○ : PARTS LOCATION**

CODE	SEE PAGE	CODE	SEE PAGE	CODE	SEE PAGE
C11	28	G 2	A 26		
G 1	B 26	I11	29		

**○ : RELAY BLOCKS**

CODE	SEE PAGE	RELAY BLOCKS (RELAY BLOCK LOCATION)
2	19	R/B NO. 2 (ENGINE COMPARTMENT LEFT)

**○ : JUNCTION BLOCK AND WIRE HARNESS CONNECTOR**

CODE	SEE PAGE	JUNCTION BLOCK AND WIRE HARNESS (CONNECTOR LOCATION)
1B	20	COWL WIRE AND J/B NO. 1 (LEFT KICK PANEL)
1G		
1K		
1L		

**□ : CONNECTOR JOINING WIRE HARNESS AND WIRE HARNESS**

CODE	SEE PAGE	JOINING WIRE HARNESS AND WIRE HARNESS (CONNECTOR LOCATION)
EA1	34	ENGINE ROOM MAIN WIRE AND R/B NO. 2 WIRE (INSIDE OF R/B NO. 2)
EB1	34	COWL WIRE AND R/B NO. 2 WIRE (INSIDE OF R/B NO. 2)
EB2		
EC1	34	COWL WIRE AND ENGINE ROOM MAIN WIRE (INSIDE OF R/B NO. 2)
ED1	34	ENGINE ROOM MAIN WIRE AND ENGINE NO. 4 WIRE (NEAR THE R/B NO. 2)

C11 GRAY

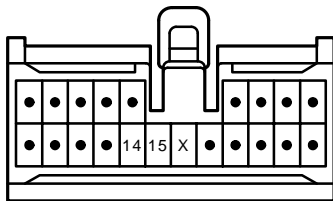

G 1 (B)

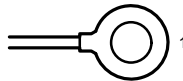

G 2 (A) GRAY

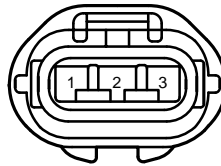

I11 BLACK

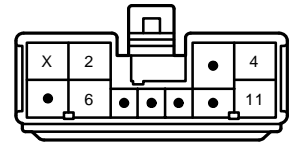

# ENGINE CONTROL

## SYSTEM OUTLINE

THE ENGINE CONTROL SYSTEM UTILIZES A MICROCOMPUTER AND MAINTAINS OVERALL CONTROL OF THE ENGINE, TRANSMISSION ETC. AN OUTLINE OF THE ENGINE CONTROL IS GIVEN HERE.

### 1. INPUT SIGNALS

#### (1) ENGINE COOLANT TEMP. (WATER TEMP.) SIGNAL CIRCUIT

THE ENGINE COOLANT TEMP. SENSOR (WATER TEMP. SENSOR) DETECTS THE ENGINE COOLANT TEMP. (WATER TEMP.) AND HAS A BUILT-IN THERMISTOR WITH A RESISTANCE, WHICH VARIES ACCORDING TO THE ENGINE COOLANT TEMP. (WATER TEMP.), WHICH IS INPUT INTO **TERMINAL THW** OF THE ENGINE CONTROL MODULE (ENGINE AND ELECTRONICALLY CONTROLLED TRANSMISSION ECU) AS A CONTROL SIGNAL.

#### (2) INTAKE AIR TEMP. SIGNAL CIRCUIT

INTAKE AIR TEMP. SENSOR IS INSTALLED IN THE VOLUME AIR FLOW (AIR FLOW METER) AND DETECTS THE INTAKE AIR TEMP., WHICH IS INPUT AS A CONTROL SIGNAL TO **TERMINAL THA** OF THE ENGINE CONTROL MODULE (ENGINE AND ELECTRONICALLY CONTROLLED TRANSMISSION ECU).

#### (3) OXYGEN DENSITY SIGNAL CIRCUIT

THE OXYGEN DENSITY IN THE EXHAUST EMISSION IS DETECTED BY THE MAIN HEATED OXYGEN SENSOR FRONT AND REAR SIDE AND INPUT AS A CONTROL SIGNAL TO **TERMINAL OX1, OX2** OF THE ENGINE CONTROL MODULE (ENGINE AND ELECTRONICALLY CONTROLLED TRANSMISSION ECU).

#### (4) RPM SIGNAL CIRCUIT

CAMSHAFT POSITION IS DETECTED BY THE PICK-UP COIL INSTALLED INSIDE THE DISTRIBUTOR. CRANKSHAFT POSITION IS INPUT AS A CONTROL SIGNAL TO **TERMINALS G1** AND **G2** OF THE ENGINE CONTROL MODULE (ENGINE AND ELECTRONICALLY CONTROLLED TRANSMISSION ECU), AND ENGINE SPEED IS INPUT INTO **TERMINAL NE**.

#### (5) THROTTLE POSITION SIGNAL CIRCUIT

THE THROTTLE POSITION SENSOR DETECTS THE THROTTLE VALVE OPENING ANGLE AS A CONTROL SIGNAL, WHICH IS INPUT INTO **TERMINAL VTA1** OF THE ENGINE CONTROL MODULE (ENGINE AND ELECTRONICALLY CONTROLLED TRANSMISSION ECU). WHEN THE VALVE IS COMPLETELY CLOSED, THE CONTROL SIGNAL IS INPUT INTO **TERMINAL IDL1**.

#### (6) VEHICLE SPEED CIRCUIT

THE VEHICLE SPEED IS DETECTED BY VEHICLE SPEED SENSOR (SPEED SENSOR) NO. 1 INSTALLED IN THE TRANSMISSION AND THE SIGNAL IS INPUT TO **TERMINAL SP1** OF THE ENGINE CONTROL MODULE (ENGINE AND ELECTRONICALLY CONTROLLED TRANSMISSION ECU) VIA THE COMBINATION METER.

#### (7) NEUTRAL POSITION SIGNAL CIRCUIT

THE PARK/NEUTRAL POSITION SW (NEUTRAL START SW) DETECTS WHETHER THE SHIFT POSITION IS IN "N" AND "P" OR NOT, AND THE SIGNAL IS INPUT INTO **TERMINAL NSW** OF THE ENGINE CONTROL MODULE (ENGINE AND ELECTRONICALLY CONTROLLED TRANSMISSION ECU).

#### (8) A/C SW SIGNAL CIRCUIT

THE OPERATING VOLTAGE OF THE A/C MAGNETIC CLUTCH IS DETECTED AND THE SIGNAL IS INPUT INTO **TERMINAL ACMG** OF ENGINE CONTROL MODULE (ENGINE AND ELECTRONICALLY CONTROLLED TRANSMISSION ECU) AS A CONTROL SIGNAL.

#### (9) BATTERY SIGNAL CIRCUIT

VOLTAGE IS CONSTANTLY APPLIED TO **TERMINAL BATT** OF THE ENGINE CONTROL MODULE (ENGINE AND ELECTRONICALLY CONTROLLED TRANSMISSION ECU). WITH THE IGNITION SW TURNED ON, THE VOLTAGE FOR ENGINE CONTROL MODULE (ENGINE AND ELECTRONICALLY CONTROLLED TRANSMISSION ECU) START-UP POWER SUPPLY IS APPLIED TO **TERMINALS +B** AND OF THE ENGINE CONTROL MODULE (ENGINE AND ELECTRONICALLY CONTROLLED TRANSMISSION ECU) VIA EFI MAIN RELAY.

THE CURRENT FLOWING THROUGH THE **AM2** FUSE FLOWS TO **TERMINAL IGSW** OF THE ENGINE CONTROL MODULE (ENGINE AND ELECTRONICALLY CONTROLLED TRANSMISSION ECU).

#### (10) INTAKE AIR VOLUME SIGNAL CIRCUIT

INTAKE AIR VOLUME IS DETECTED BY THE VOLUME AIR FLOW (AIR FLOW METER) AND THE SIGNAL IS INPUT TO **TERMINAL KS** OF THE ENGINE CONTROL MODULE (ENGINE AND ELECTRONICALLY CONTROLLED TRANSMISSION ECU) AS A CONTROL SIGNAL.

#### (11) STOP LIGHT SW SIGNAL CIRCUIT

THE STOP LIGHT SW IS USED TO DETECT WHETHER OR NOT THE VEHICLE IS BRAKING AND THE SIGNAL IS INPUT INTO **TERMINAL STP** OF THE ENGINE CONTROL MODULE (ENGINE AND ELECTRONICALLY CONTROLLED TRANSMISSION ECU) AS A CONTROL SIGNAL.

#### (12) STARTER SIGNAL CIRCUIT

TO CONFIRM WHETHER THE ENGINE IS CRANKING, THE VOLTAGE APPLIED TO THE STARTER MOTOR DURING CRANKING IS DETECTED AND THE SIGNAL IS INPUT INTO **TERMINAL STA** OF THE ENGINE CONTROL MODULE (ENGINE AND ELECTRONICALLY CONTROLLED TRANSMISSION ECU) AS A CONTROL SIGNAL.

#### (13) ENGINE KNOCK SIGNAL CIRCUIT

ENGINE KNOCKING IS DETECTED BY KNOCK SENSOR FRONT AND REAR SIDE AND THE SIGNAL IS INPUT INTO **TERMINALS KNK1** AND **KNK2** AS A CONTROL SIGNAL.



## 2. CONTROL SYSTEM

### \* SEQUENTIAL MULTIPOINT FUEL INJECTION (ELECTRONICALLY FUEL INJECTION) SYSTEM

THE SEQUENTIAL MULTIPOINT FUEL INJECTION (ELECTRONICALLY FUEL INJECTION) SYSTEM MONITORS THE ENGINE CONDITION THROUGH THE SIGNALS INPUT FROM EACH SENSOR (INPUT SIGNAL FROM (1) TO (13) ETC.) TO THE ENGINE CONTROL MODULE (ENGINE AND ELECTRONICALLY CONTROLLED TRANSMISSION ECU). THE BEST FUEL INJECTION TIMING IS DECIDED BASED ON THIS DATA AND THE PROGRAM MEMORIZED BY THE ENGINE CONTROL MODULE (ENGINE AND ELECTRONICALLY CONTROLLED TRANSMISSION ECU), AND THE CONTROL SIGNAL IS OUTPUT TO **TERMINALS #10, #20, #30, #40, #50 AND #60** OF THE ENGINE CONTROL MODULE (ENGINE AND ELECTRONICALLY CONTROLLED TRANSMISSION ECU) TO OPERATE THE INJECTOR. (INJECT THE FUEL). THE SEQUENTIAL MULTIPOINT FUEL INJECTION (ELECTRONICALLY FUEL INJECTION) SYSTEM CONTROLS OF FUEL INJECTION OPERATION BY THE ENGINE CONTROL MODULE (ENGINE AND ELECTRONICALLY CONTROLLED TRANSMISSION ECU) IN RESPONSE TO THE DRIVING CONDITIONS.

### \* ESA (ELECTRONIC SPARK ADVANCE) SYSTEM

THE ESA SYSTEM MONITORS THE ENGINE CONDITION THROUGH THE SIGNALS INPUT TO THE ENGINE CONTROL MODULE (ENGINE AND ELECTRONICALLY CONTROLLED TRANSMISSION ECU) FROM EACH SENSOR (INPUT SIGNALS FROM (1), (2), (4) TO (13) ETC.). THE BEST IGNITION TIMING IS DECIDED ACCORDING TO THIS DATA AND THE MEMORIZED DATA IN THE ENGINE CONTROL MODULE (ENGINE AND ELECTRONICALLY CONTROLLED TRANSMISSION ECU) AND THE CONTROL SIGNAL IS OUTPUT TO **TERMINALS IGT** THIS SIGNAL CONTROLS THE IGNITER TO PROVIDE THE BEST IGNITION TIMING FOR THE DRIVING CONDITIONS.

### \* HEATED OXYGEN SENSOR HEATER CONTROL SYSTEM

THE MAIN HEATED OXYGEN SENSOR FRONT AND REAR SIDE. SUB HEATED OXYGEN SENSOR HEATER CONTROL SYSTEM TURNS THE HEATER ON WHEN THE INTAKE AIR VOLUME IS LOW (TEMP. OF EXHAUST EMISSIONS IS LOW), AND WARMS UP THE OXYGEN SENSOR TO IMPROVE DETECTION PERFORMANCE OF THE SENSOR. THE ENGINE CONTROL MODULE (ENGINE AND ELECTRONICALLY CONTROLLED TRANSMISSION ECU) EVALUATES THE SIGNALS FROM EACH SENSOR (INPUT SIGNALS FROM (1), (2), (4), (9) TO (11) ETC.), AND OUTPUTS CURRENT TO **TERMINAL HT1, HT2, HT3** TO CONTROL THE HEATER.

### \* IDLE AIR CONTROL (IDLE SPEED CONTROL) SYSTEM

THE IDLE AIR CONTROL (ISC) SYSTEM (STEP MOTOR TYPE) INCREASES THE ENGINE SPEED AND PROVIDES IDLING STABILITY FOR FAST IDLE-UP WHEN THE ENGINE IS COLD, AND WHEN THE IDLE SPEED HAS DROPPED DUE TO ELECTRICAL LOAD AND SO ON. THE ENGINE CONTROL MODULE (ENGINE AND ELECTRONICALLY CONTROLLED TRANSMISSION ECU) EVALUATES THE SIGNALS FROM EACH SENSOR (INPUT SIGNALS FROM (1), (4), (5), (8), (9), (11) ETC.), OUTPUTS CURRENT TO **TERMINALS ISC1, ISC2, ISC3 AND ISC4** TO CONTROL THE IDLE AIR CONTROL VALVE (ISC VALVE).

### \* EGR CONTROL SYSTEM

THE EGR CONTROL SYSTEM DETECTS THE SIGNAL FROM EACH SENSOR (INPUT SIGNALS FROM (1), (4), (9), (10) ETC.), AND OUTPUTS CURRENT TO **TERMINALS EGR** TO CONTROL THE EGR VALVE.

### \* FUEL PUMP CONTROL SYSTEM

THE ENGINE CONTROL MODULE (ENGINE AND ELECTRONICALLY CONTROLLED TRANSMISSION ECU) OUTPUTS CURRENT TO **TERMINAL FPC** AND CONTROLS THE FUEL PUMP ECU AND FUEL PUMP DRIVE SPEED IN RESPONSE TO THE DRIVING CONDITIONS.

### \* ACIS (ACOUSTIC CONTROL INDUCTION SYSTEM)

ACIS INCLUDES A VALVE IN THE BULKHEAD SEPARATING THE SURGE TANK INTO TWO PARTS. THIS VALVE IS OPENED AND CLOSED IN ACCORDANCE WITH THE DRIVING CONDITIONS TO CONTROL THE INTAKE MANIFOLD LENGTH IN TWO STAGES FOR INCREASED ENGINE OUTPUT IN ALL RANGES FROM LOW TO HIGH SPEEDS.

THE ENGINE CONTROL MODULE (ENGINE AND ELECTRONICALLY CONTROLLED TRANSMISSION ECU) JUDGES THE VEHICLE SPEED BY THE SIGNALS ((4), (5)) FROM EACH SENSOR AND OUTPUTS SIGNALS TO THE **TERMINAL ACIS** TO CONTROL THE VSV (FOR INTAKE CONTROL VALVE).

## 3. DIAGNOSIS SYSTEM

WITH THE DIAGNOSIS SYSTEM, WHEN THERE IS A MALFUNCTION IN THE ENGINE CONTROL MODULE (ENGINE AND ELECTRONICALLY CONTROLLED TRANSMISSION ECU) SIGNAL SYSTEM, THE MALFUNCTIONING SYSTEM IS RECORDED IN THE MEMORY. THE MALFUNCTIONING SYSTEM CAN BE FOUND BY READING THE CODE DISPLAYED BY THE MALFUNCTION INDICATOR LAMP (CHECK ENGINE WARNING LIGHT).

## 4. FAIL-SAFE SYSTEM

WHEN A MALFUNCTION HAS OCCURRED IN ANY SYSTEM, IF THERE IS A POSSIBILITY OF ENGINE TROUBLE BEING CAUSED BY CONTINUED CONTROL BASED ON THE SIGNALS FROM THAT SYSTEM, THE FAIL-SAFE SYSTEM EITHER CONTROLS THE SYSTEM BY USING DATA (STANDARD VALUES) RECORDED IN THE ENGINE CONTROL MODULE (ENGINE AND ELECTRONICALLY CONTROLLED TRANSMISSION ECU) MEMORY OR ELSE STOPS THE ENGINE.

# ENGINE CONTROL

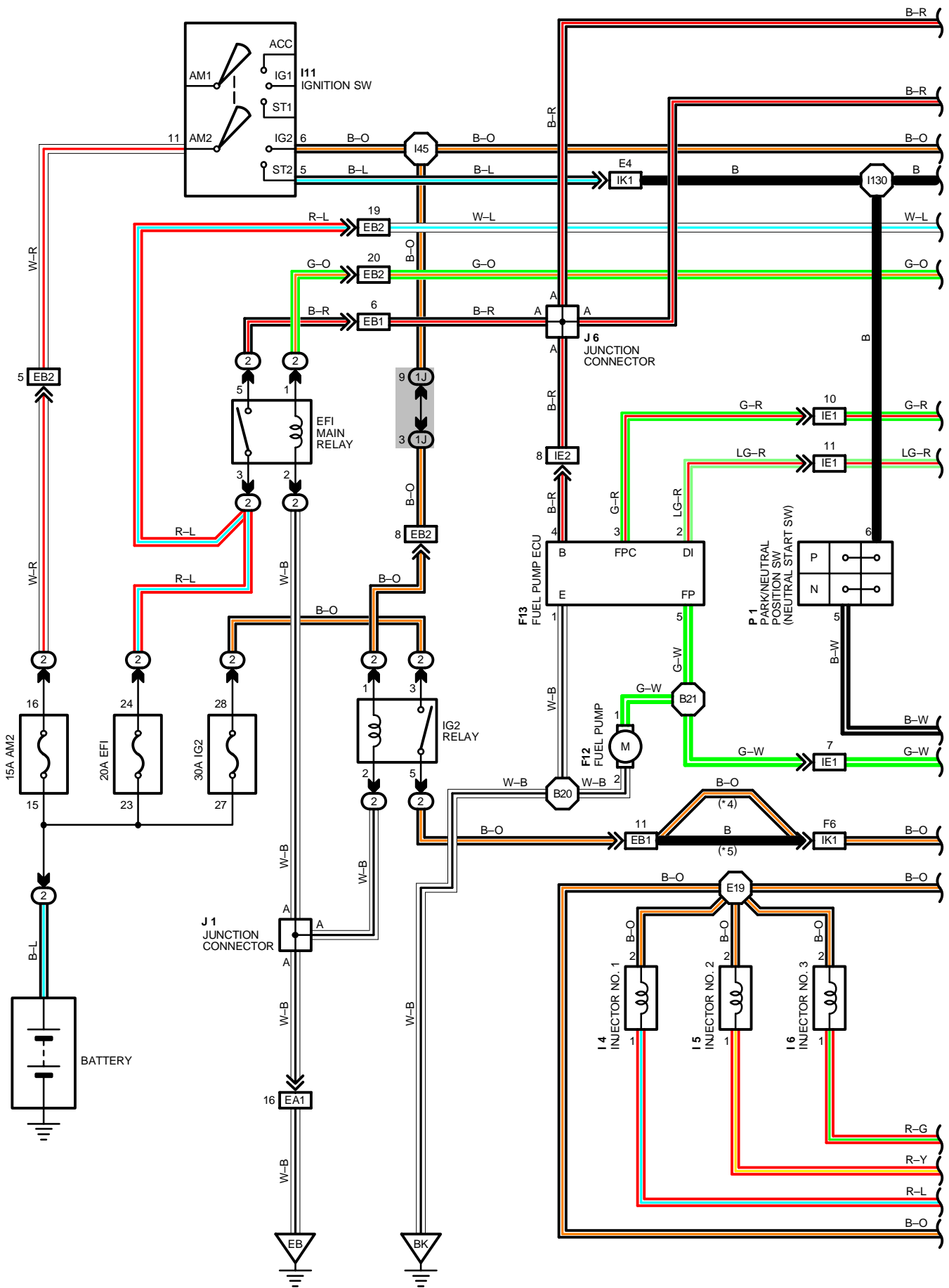

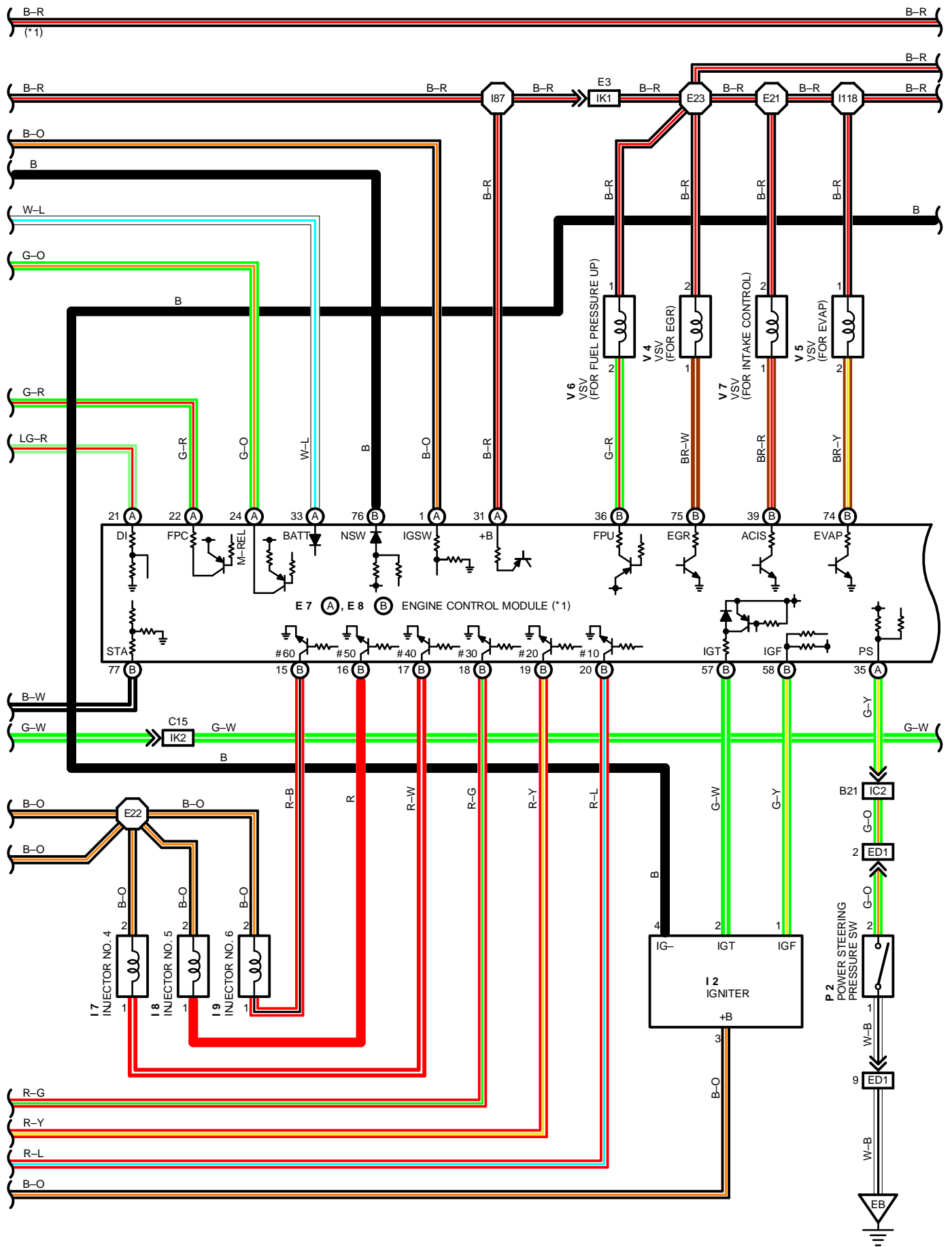

# ENGINE CONTROL

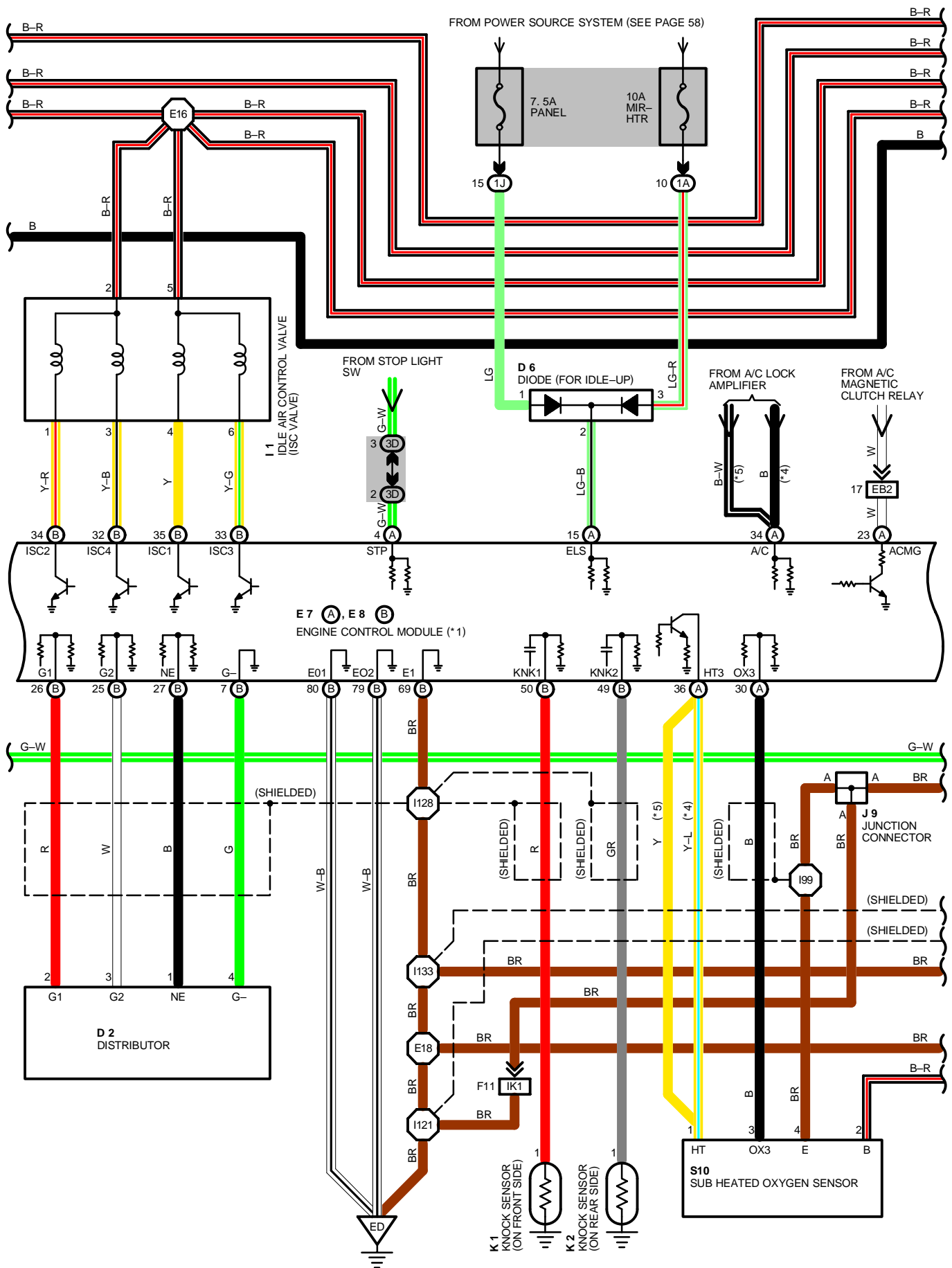

- \*1 : ENGINE AND ELECTRONICALLY CONTROLLED TRANSMISSION ECU
- \*2 : W/ TRACTION CONTROL
- \*3 : W/O TRACTION CONTROL
- \*4 : USA
- \*5 : CANADA

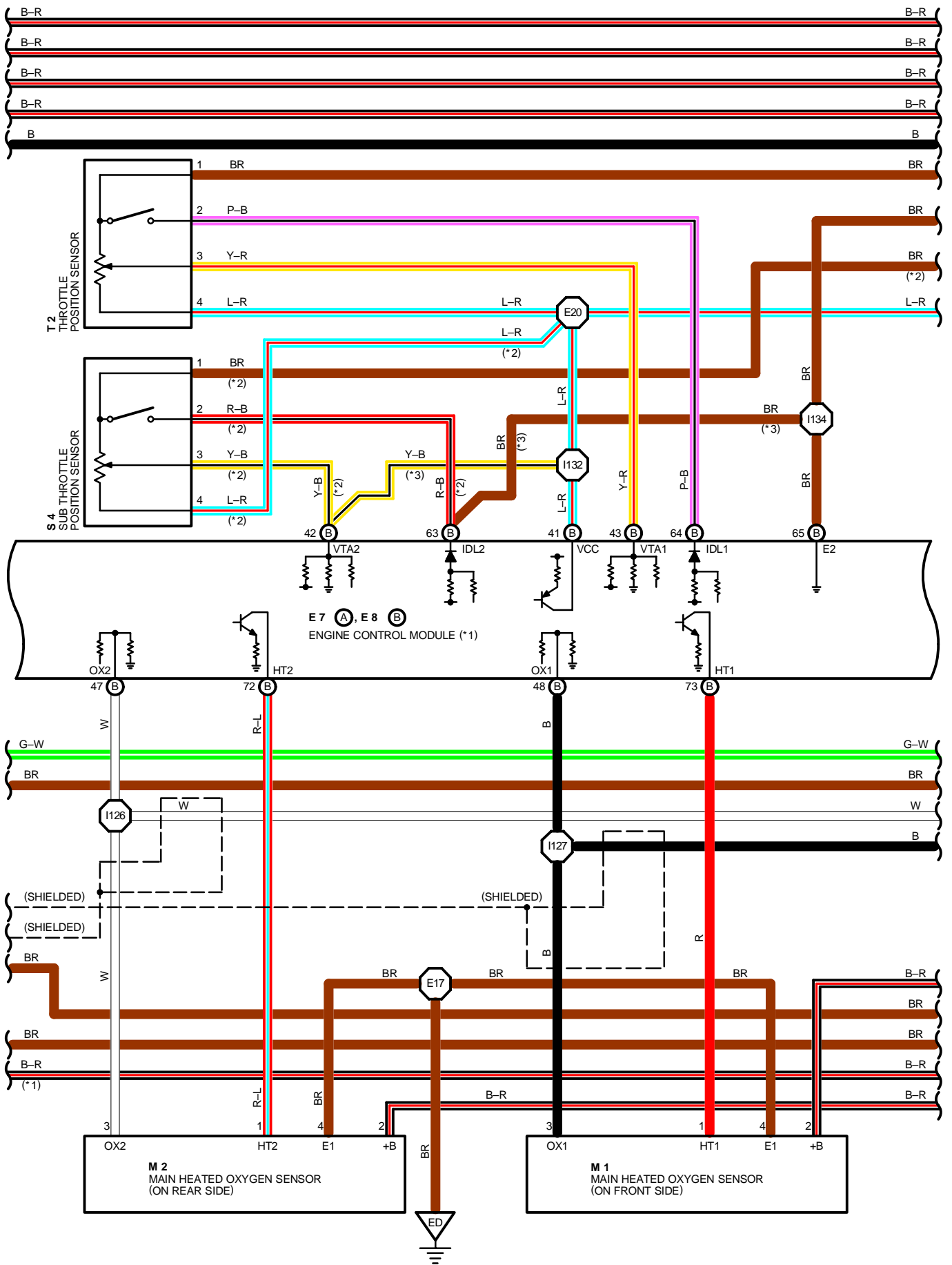

# ENGINE CONTROL

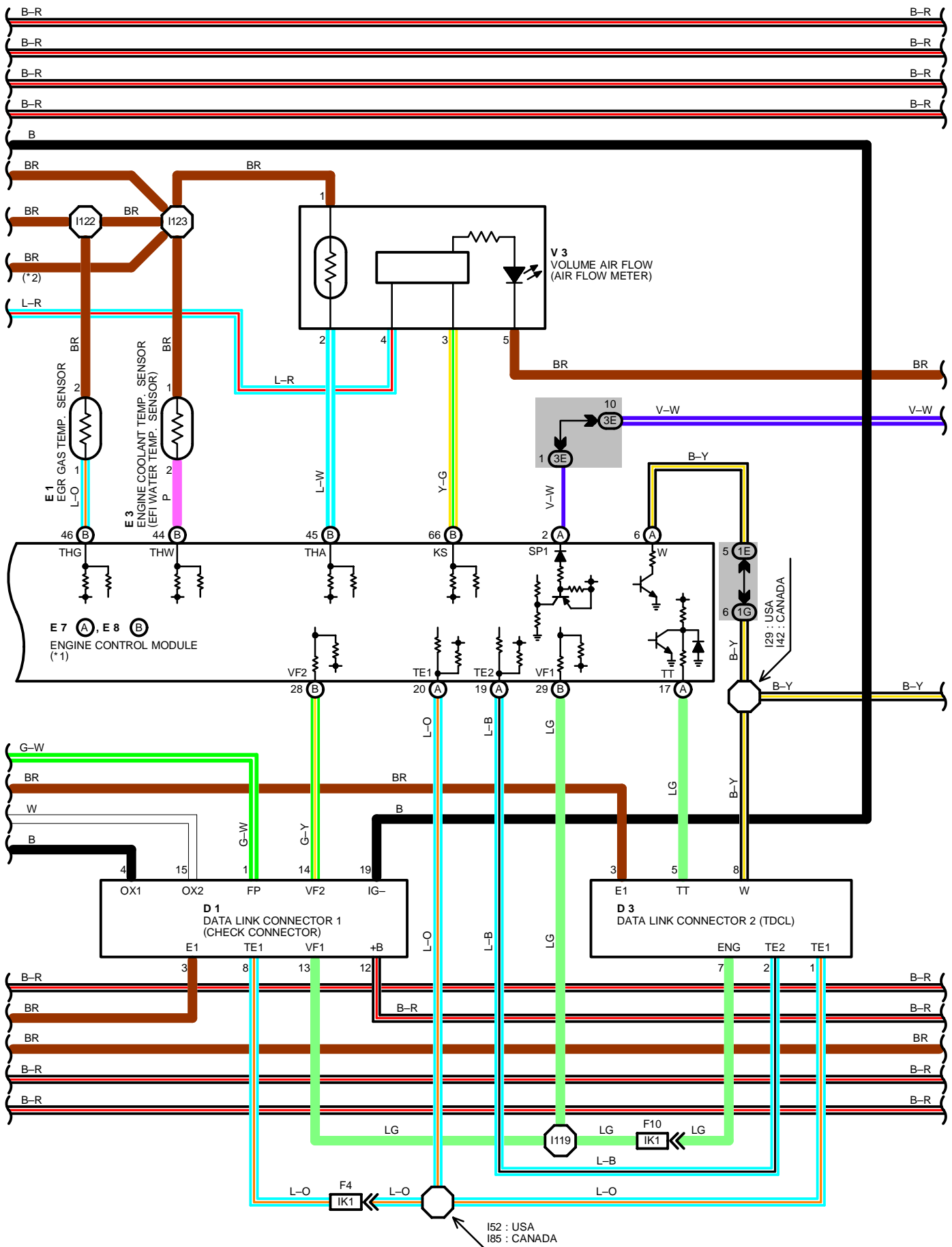

- \* 1 : ENGINE AND ELECTRONICALLY CONTROLLED TRANSMISSION ECU
- \* 2 : W/ TRACTION CONTROL
- \* 3 : W/O TRACTION CONTROL

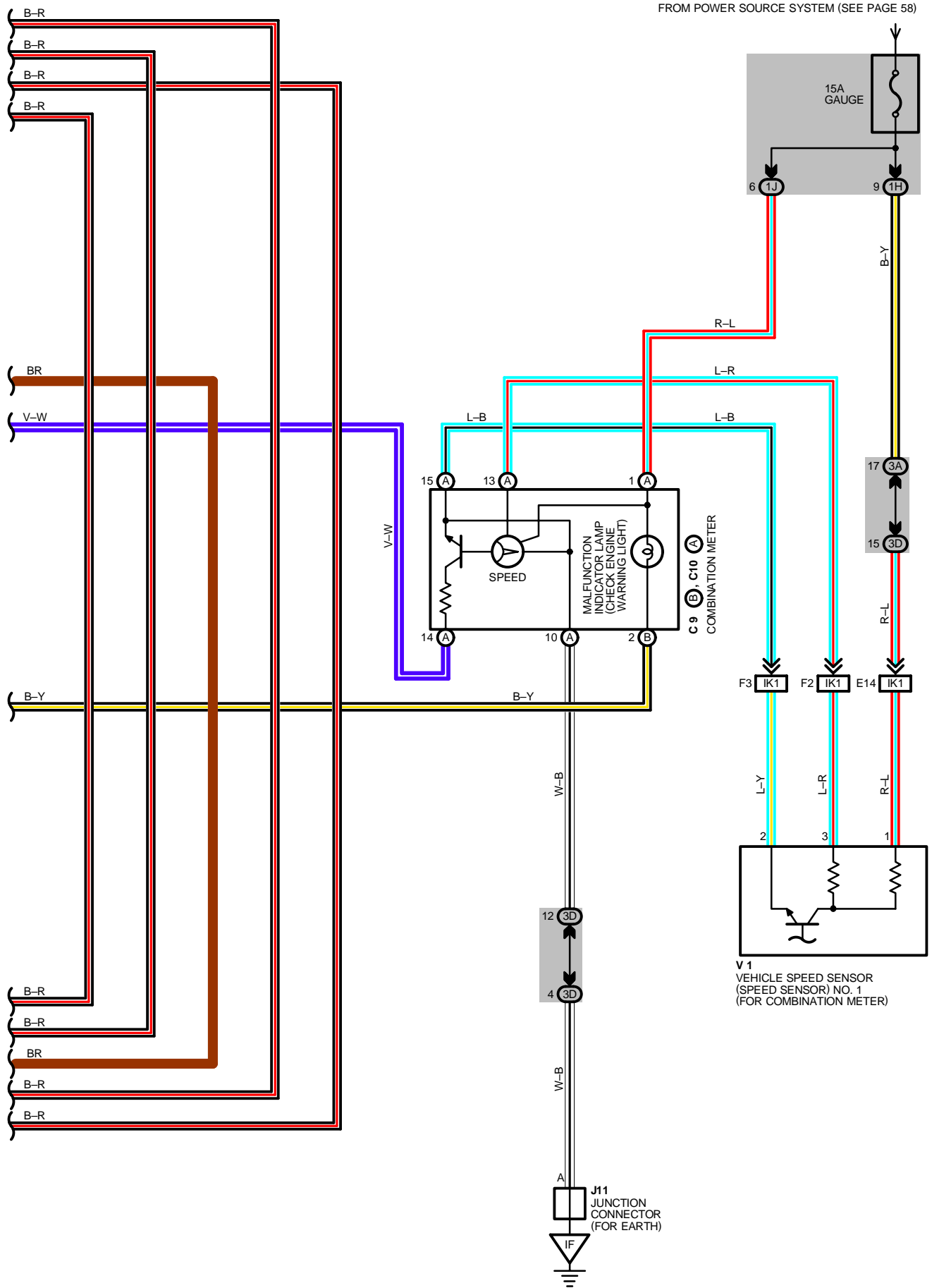

# ENGINE CONTROL

## SERVICE HINTS

### EFI MAIN RELAY

(2)3–(2)5 : CLOSED WITH IGNITION SW AT ON POSITION

### E 3 ENGINE COOLANT TEMP. SENSOR (EFI WATER TEMP. SENSOR)

1–2: 10–20 K (–20°C, –4°F)  
4–7 K (0°C, 32°F)  
2–3 K (20°C, 68°F)  
0.9–1.3 K (40°C, 104°F)  
0.4–0.7 K (60°C, 140°F)  
0.2–0.4 K (80°C, 176°F)

### I 1 IDLE AIR CONTROL VALVE (ISC VALVE)

1, 3–2 : APPROX. 10–30  
4, 6–5 : APPROX. 10–30

### I 4, I 5, I 6, I 7, I 8, I 9 INJECTOR

1–2 : APPROX. 13.8

### T2 THROTTLE POSITION SENSOR

1–4 : APPROX. 4–9  
1–3 : 3.3–10.0 K WITH THROTTLE VALVE FULLY OPENED POSITION  
0.2–0.8 K WITH CLEARANCE BETWEEN LEVER AND STOP SCREW 0 MM (0 IN.)  
1–2 : 0–2.3 K WITH CLEARANCE BETWEEN LEVER AND STOP SCREW 0.45 MM (0.018 IN.)  
INFINITY WITH CLEARANCE BETWEEN LEVER AND STOP SCREW 0.55 MM (0.022 IN.)

### E 7(A), E 8(B) ENGINE CONTROL MODULE (ENGINE AND ELECTRONICALLY CONTROLLED TRANSMISSION ECU) (VOLTAGE AT ENGINE AND ELECTRONICALLY CONTROLLED TRANSMISSION ECU WIRING CONNECTORS)

BATT – E1 : 9–14 VOLTS  
IGSW – E1 : 9–14 VOLTS WITH IGNITION SW ON  
M–REL – E1 : 9–14 VOLTS WITH IGNITION SW ON  
+B – E1 : 9–14 VOLTS WITH IGNITION SW ON  
IDL1 – E2 : 9–14 VOLTS WITH IGNITION SW ON AND THROTTLE VALVE OPEN  
VTA1 – E2 : 0.3–0.8 VOLTS WITH IGNITION SW ON AND THROTTLE VALVE FULLY CLOSED  
3.2–4.4 VOLTS WITH IGNITION SW ON AND THROTTLE VALVE OPEN  
#10, #20, #30, #40, #50, #60 – E01, E02 : 9–14 VOLTS WITH IGNITION SW ON  
THA – E2 : 0.5–3.4 VOLTS WITH IGNITION SW ON AND INTAKE AIR TEMP. 20°C (68°F)  
THW – E2 : 0.2–1.0 VOLTS WITH IGNITION SW ON AND COOLANT TEMP. 80°C (176°F)  
STA – E1 : 6–14 VOLTS WITH ENGINE CRANKING  
ISC1, ISC2, ISC3, ISC4 – E1 : 10–14 VOLTS WITH IGNITION SW ON  
W – E1 : 9–14 VOLTS WITH ENGINE IDLING  
ACIS – E1 : 9–14 VOLTS WITH IGNITION SW ON  
IGF – E1 : 0–1.5 VOLTS WITH IGNITION SW ON  
NSW – E1 : 0–3 VOLTS WITH IGNITION SW ON AND SHIFT LEVER P OR N POSITION  
9–14 VOLTS WITH IGNITION SW ON AND SHIFT LEVER EXCEPT P OR N POSITION  
SP1 : 0–4 VOLTS WITH IGNITION SW ON AND ROTATE DRIVING WHEEL ONLY  
TE1, TE2 – E1 : 9–14 VOLTS WITH IGNITION SW ON AND DATA LINK CONNECTOR 1 (CHECK CONNECTOR)  
TE1–E1 NOT CONNECTED  
0–1 VOLTS WITH IGNITION SW ON AND DATA LINK CONNECTOR 1 (CHECK CONNECTOR)  
TE1–E1 CONNECTED  
A/C – E1 : 0–1.5 VOLTS WITH IGNITION SW ON AND AIR CONDITIONING OFF  
7.5–14 VOLTS WITH IGNITION SW ON AND AIR CONDITIONING ON  
ELS – E1 : 9–14 VOLTS WITH TAILLIGHT ON, DEFOGGER ON  
0–3 VOLTS WITH TAILLIGHT OFF, DEFOGGER OFF  
STP – E1 : 9–14 VOLTS WITH STOP LIGHT SW ON (BRAKE PEDAL DEPRESSED)  
0–3 VOLTS WITH STOP LIGHT SW OFF

### (RESISTANCE OF ENGINE AND ELECTRONICALLY CONTROLLED TRANSMISSION ECU WIRING CONNECTORS)

IDL1 – E2 : INFINITY WITH THROTTLE VALVE OPEN  
0–2.3 K WITH THROTTLE VALVE FULLY CLOSED  
VTA1 – E2 : 3.3 K –10.0 K WITH THROTTLE VALVE FULLY OPEN  
200 –800 WITH THROTTLE VALVE FULLY CLOSED  
VCC – E2 : 4 K –9 K  
THA – E2 : 2 K –3 K WITH INTAKE AIR TEMP. 20°C (68°F)  
THW – E2 : 200 –400 WITH COOLANT TEMP. 80°C (176°F)  
ISC1, ISC2, ISC3, ISC4 – +B : 10–30  
#10, #20, #30, #40, #50, #60 – +B : 13.2 –14.2  
ACIS – +B : 38.5 –44.5



 : PARTS LOCATION

CODE	SEE PAGE	CODE	SEE PAGE	CODE	SEE PAGE
C9	B 28	I4	26	M2	27
C10	A 28	I5	26	M3	27
D1	26	I6	26	M4	27
D2	26	I7	26	P1	27
D3	28	I8	26	P2	27
D6	28	I9	26	S4	27
E1	26	I11	29	S10	29
E3	26	J1	27	T2	27
E7	A 28	J6	29	V1	27
E8	B 28	J9	29	V3	27
F12	30	J11	29	V4	27
F13	30	K1	27	V5	27
I1	26	K2	27	V6	27
I2	26	M1	27	V7	27

 : RELAY BLOCKS

CODE	SEE PAGE	RELAY BLOCKS (RELAY BLOCK LOCATION)
2	19	R/B NO. 2 (ENGINE COMPARTMENT LEFT)

 : JUNCTION BLOCK AND WIRE HARNESS CONNECTOR

CODE	SEE PAGE	JUNCTION BLOCK AND WIRE HARNESS (CONNECTOR LOCATION)
1A	20	COWL WIRE AND J/B NO. 1 (LEFT KICK PANEL)
1E		
1G		
1H		
1J		
3A	22	COWL WIRE AND J/B NO. 3 (BEHIND INSTRUMENT PANEL CENTER)
3D		
3E		

 : CONNECTOR JOINING WIRE HARNESS AND WIRE HARNESS

CODE	SEE PAGE	JOINING WIRE HARNESS AND WIRE HARNESS (CONNECTOR LOCATION)
EA1	34	ENGINE ROOM MAIN WIRE AND R/B NO. 2 WIRE (INSIDE OF R/B NO. 2)
EB1	34	COWL WIRE AND R/B NO. 2 WIRE (INSIDE OF R/B NO. 2)
EB2		
ED1	34	ENGINE ROOM MAIN WIRE AND ENGINE NO. 4 WIRE (NEAR THE R/B NO. 2)
IC2	36	ENGINE ROOM MAIN WIRE AND COWL WIRE (UNDER THE GLOVE BOX)
IE1	36	COWL WIRE AND FLOOR NO. 2 WIRE (LEFT KICK PANEL)
IE2		
IK1	38	ENGINE WIRE AND COWL WIRE (UNDER THE GLOVE BOX)
IK2		

 : GROUND POINTS

CODE	SEE PAGE	GROUND POINTS LOCATION
EB	34	FRONT SIDE OF LEFT FENDER
ED	34	REAR SIDE OF INTAKE MANIFOLD
IF	36	BEHIND COMBINATION METER
BK	40	UNDER THE FRONT SEAT LH

# ENGINE CONTROL

 : SPLICE POINTS

CODE	SEE PAGE	WIRE HARNESS WITH SPLICE POINTS	CODE	SEE PAGE	WIRE HARNESS WITH SPLICE POINTS
E16	34	ENGINE WIRE	I89	38	COWL WIRE
E17					
E18					
E19					
E20					
E21					
E22					
E23					
I29	38	ENGINE WIRE	I118	38	ENGINE WIRE
I42					
I45					
I52					
I64					
I77					
I85					
I87					
			B20	40	FLOOR NO. 2 WIRE
			B21		

C 9 (B)

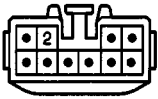

C10 (A) ORANGE

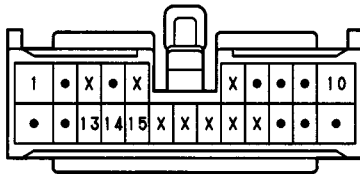

D 1 BLACK

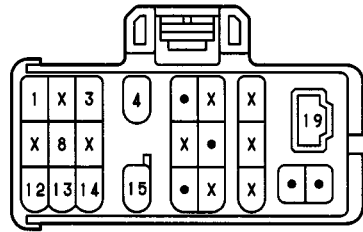

D 2 BLACK

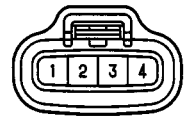

D 3

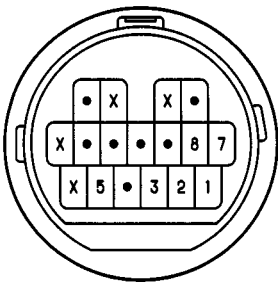

D 6 ORANGE



E 1 DARK GRAY



E 3 GREEN



E 7 (A) DARK GRAY

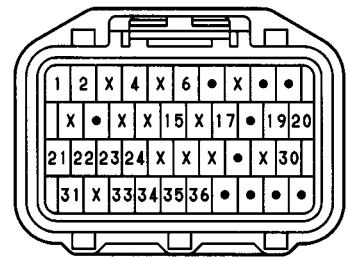

E 8 (B) DARK GRAY

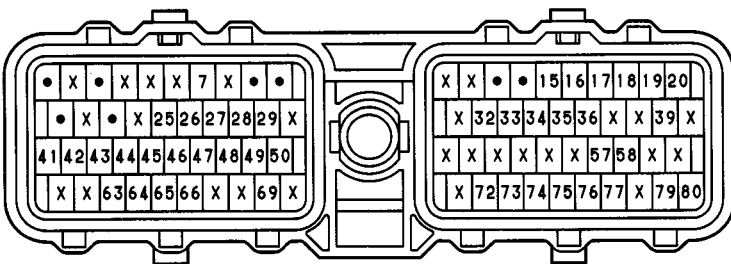

F12 DARK GRAY

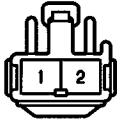

F13 BLACK

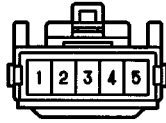

I 1 GRAY



I 2 BLACK

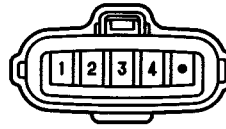

I 4, I 6, I 8 DARK GRAY



I 5, I 7, I 9 BROWN



I11 BLACK

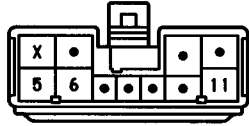

J 1



(HINT:SEE PAGE 7)

J 6 GRAY



(HINT:SEE PAGE 7)

J 9 GRAY

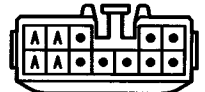

(HINT:SEE PAGE 7)

J11

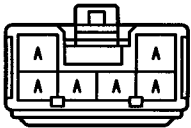

(HINT:SEE PAGE 7)

K 1, K 2 DARK GRAY



M 1, M 2 DARK GRAY



M 3 DARK GRAY



M 4 DARK GRAY

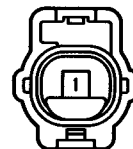

P 1 GRAY

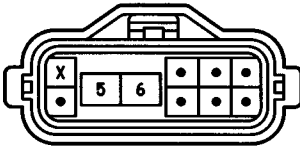

P 2 DARK GRAY



S 4 BLACK



S10 DARK GRAY



T 2 BLACK



V 1 BLACK



V 3 BLACK



V 4 BLACK



V 5 BLUE



V 6 BLUE



V 7 BROWN



# HEADLIGHT (FOR USA)

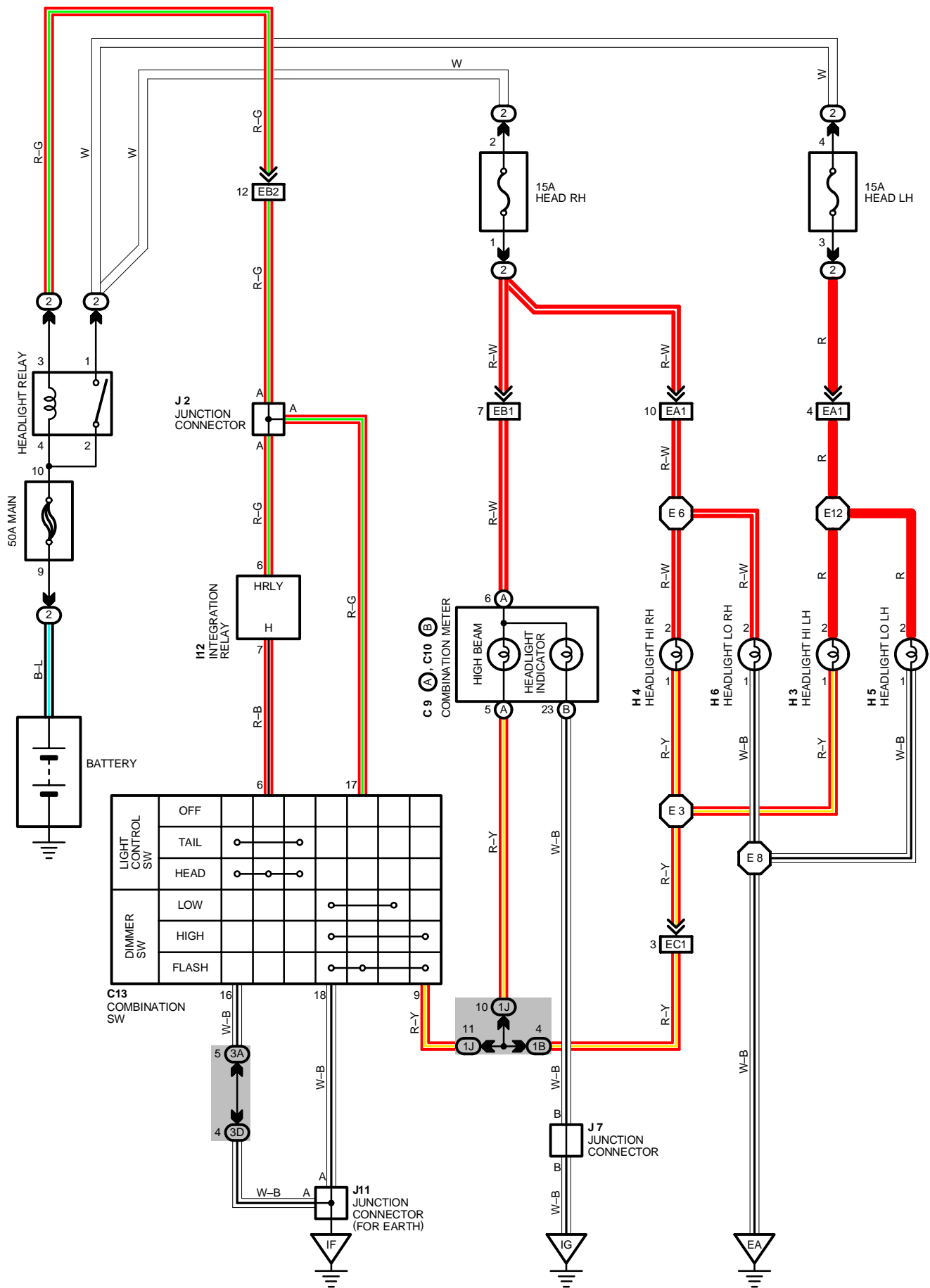

## SERVICE HINTS

### HEADLIGHT RELAY

(2) 2-(2) 1 : CLOSED WITH LIGHT CONTROL SW AT **HEAD** POSITION OR DIMMER SW AT **FLASH** POSITION

### C13 LIGHT CONTROL SW [COMB. SW]

6-16 : CLOSED WITH LIGHT CONTROL SW AT **HEAD** POSITION

### C13 DIMMER SW [COMB. SW]

17-18 : CLOSED WITH DIMMER SW AT **FLASH** POSITION

9-18 : CLOSED WITH DIMMER SW AT **HIGH** OR **FLASH** POSITION

### ○ : PARTS LOCATION

CODE	SEE PAGE	CODE	SEE PAGE	CODE	SEE PAGE
C 9	A	28		H 4	26
C10	B	28		H 5	26
C13	28	H 6	26	J 2	29
H 3	26	I12	29	J 7	29
				J11	29

### ○ : RELAY BLOCKS

CODE	SEE PAGE	RELAY BLOCKS (RELAY BLOCK LOCATION)
2	19	R/B NO. 2 (ENGINE COMPARTMENT LEFT)

### ○ : JUNCTION BLOCK AND WIRE HARNESS CONNECTOR

CODE	SEE PAGE	JUNCTION BLOCK AND WIRE HARNESS (CONNECTOR LOCATION)
1B	20	COWL WIRE AND J/B NO. 1 (LEFT KICK PANEL)
1J		
3A	22	COWL WIRE AND J/B NO. 3 (BEHIND THE INSTRUMENT PANEL CENTER)
3D		

### □ : CONNECTOR JOINING WIRE HARNESS AND WIRE HARNESS

CODE	SEE PAGE	JOINING WIRE HARNESS AND WIRE HARNESS (CONNECTOR LOCATION)
EA1	34	ENGINE ROOM MAIN WIRE AND R/B NO. 2 WIRE (INSIDE OF R/B NO. 2)
EB1	34	COWL WIRE AND R/B NO. 2 WIRE (INSIDE OF R/B NO. 2)
EB2		
EC1	34	COWL WIRE AND ENGINE ROOM MAIN WIRE (INSIDE OF R/B NO. 2)

### ▽ : GROUND POINTS

CODE	SEE PAGE	GROUND POINTS LOCATION
EA	34	FRONT SIDE OF RIGHT FENDER
IF	36	BEHIND COMBINATION METER
IG	36	BEHIND GOLVE BOX

### ○ : SPLICE POINTS

CODE	SEE PAGE	WIRE HARNESS WITH SPLICE POINTS	CODE	SEE PAGE	WIRE HARNESS WITH SPLICE POINTS
E 3	34	ENGINE ROOM MAIN WIRE	E 8	34	ENGINE ROOM MAIN WIRE
E 6			E12		

C 9 (A)

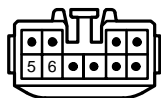

C10 (B) ORANGE

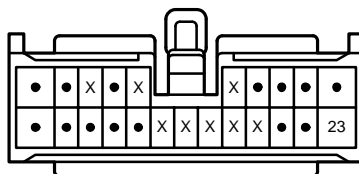

C13

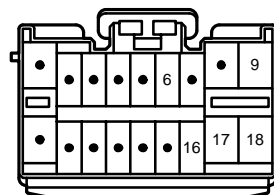

H 3, H 4 BLACK



H 5, H 6 BROWN



I12

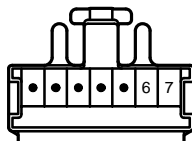

J 2

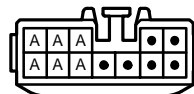

(HINT : SEE PAGE 7)

J 7 GRAY

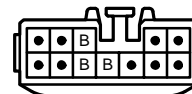

(HINT : SEE PAGE 7)

J11

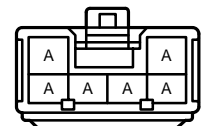

(HINT : SEE PAGE 7)

# HEADLIGHT (FOR CANADA)

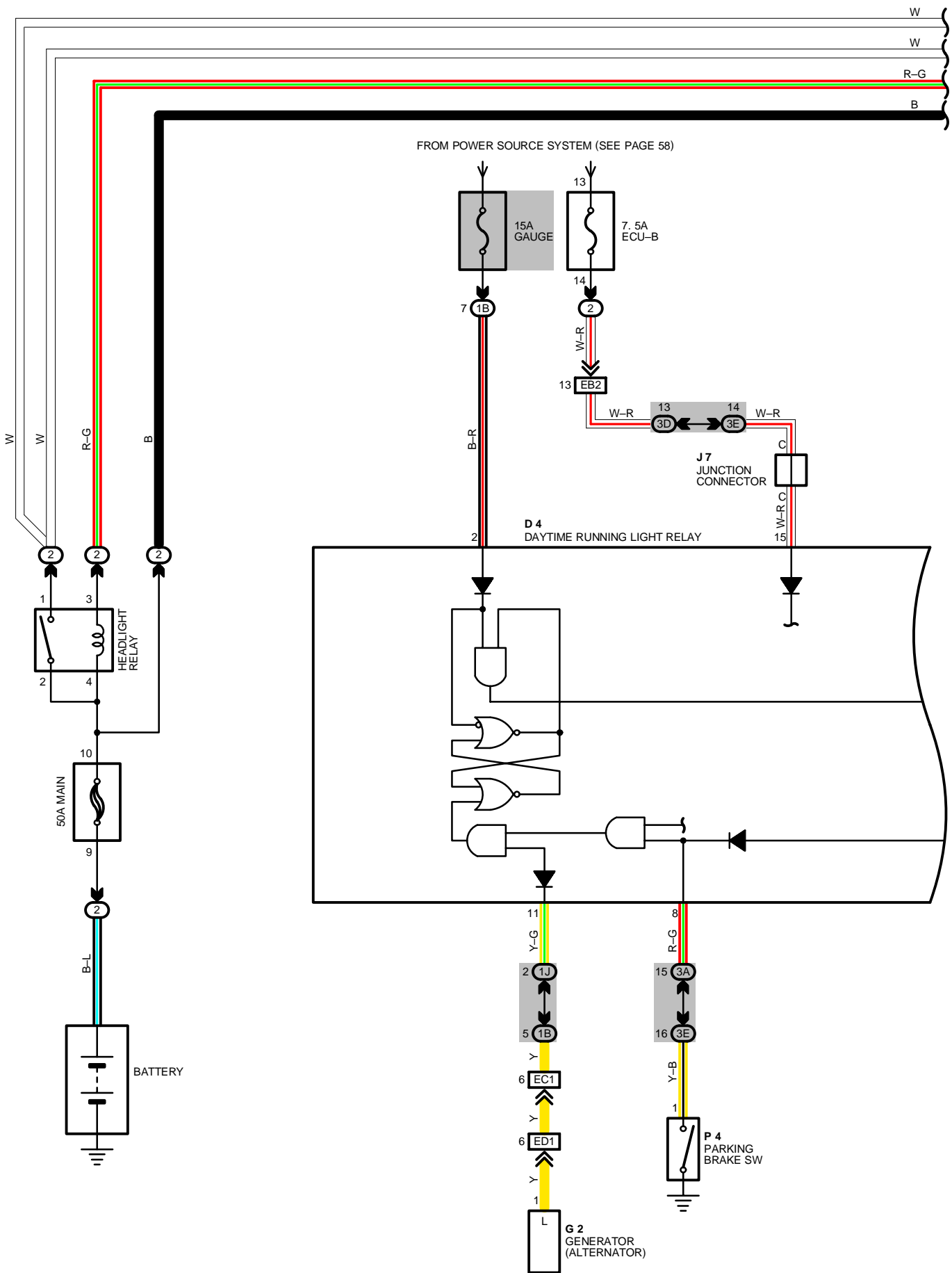



# HEADLIGHT (FOR CANADA)

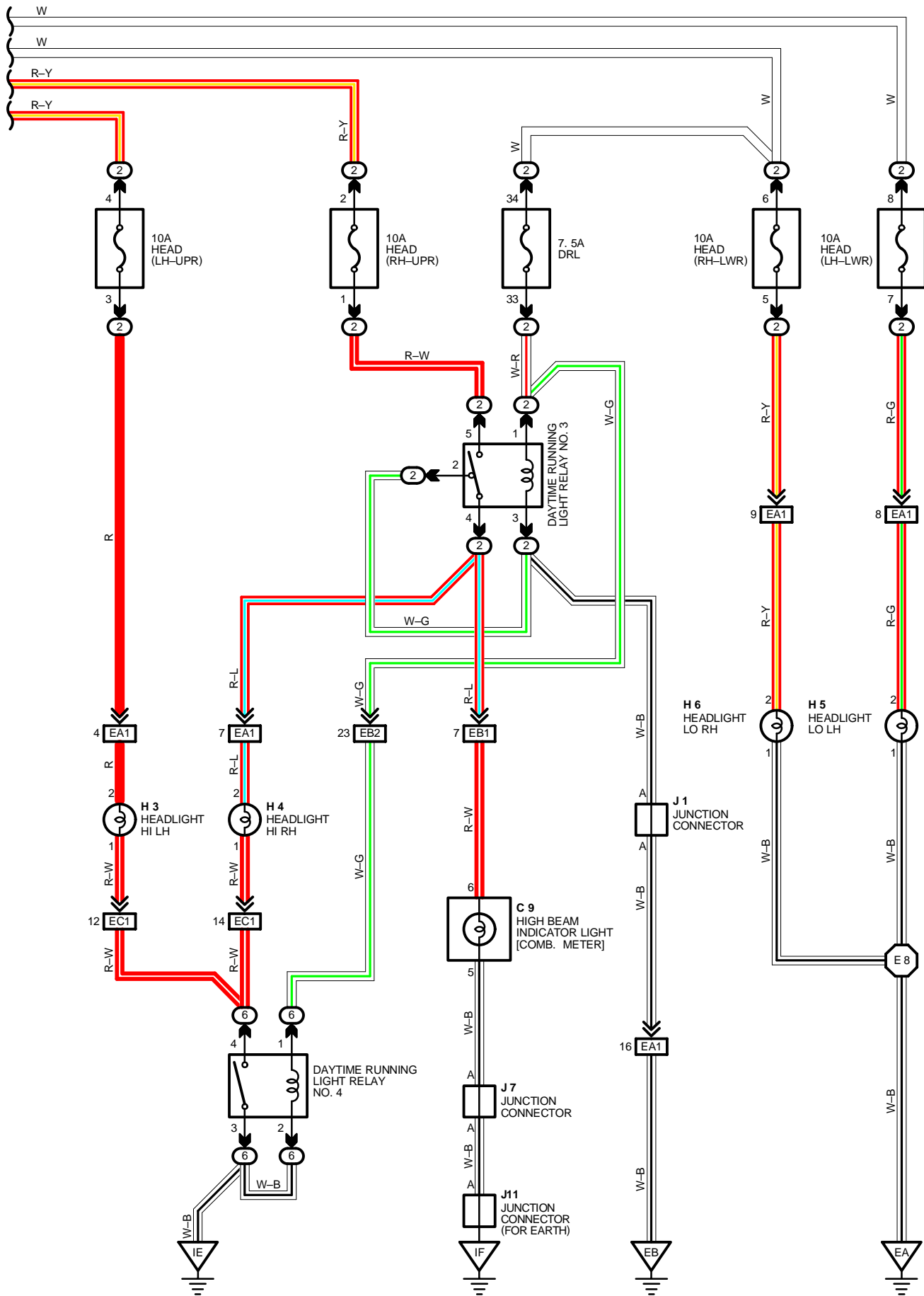



## SYSTEM OUTLINE

VOLTAGE IS ALWAYS APPLIED FROM THE **MAIN** FUSE, THROUGH THE HEADLIGHT RELAY (COIL SIDE) TO **TERMINAL 5** OF THE DAYTIME RUNNING LIGHT RELAY, **TERMINAL 6** OF INTEGRATION RELAY, **TERMINAL 17** OF DIMMER SW, DAYTIME RUNNING LIGHT RELAY NO. 2 (COIL SIDE), TO **TERMINAL 17** OF THE DAYTIME RUNNING LIGHT RELAY. WHEN THE IGNITION SW IS TURNED ON, VOLTAGE FROM THE **GAUGE** FUSE IS APPLIED TO **TERMINAL 2** OF THE DAYTIME RUNNING LIGHT RELAY.

### 1. DAYTIME RUNNING LIGHT OPERATION

WHEN THE ENGINE STARTS, VOLTAGE FROM **TERMINAL L** OF THE GENERATOR (ALTERNATOR) IS APPLIED TO **TERMINAL 11** OF THE DAYTIME RUNNING LIGHT RELAY. IF THE PARKING BRAKE PEDAL IS DEPRESSED (PARKING BRAKE SW ON) AT THIS TIME, THE RELAY AND THE DAYTIME RUNNING LIGHT DO NOT OPERATE.

WHEN THE PARKING BRAKE IS RELEASED (PARKING BRAKE SW OFF), A SIGNAL IS OUTPUT FROM **TERMINAL 1** OF THE PARKING BRAKE SW TO **TERMINAL 8** OF THE DAYTIME RUNNING LIGHT RELAY. THIS ACTIVATES THE DAYTIME RUNNING LIGHT RELAY, TURNING ON THE DAYTIME RUNNING LIGHT RELAY NO. 2. CURRENT ALSO FLOWS FROM THE **MAIN** FUSE TO DAYTIME RUNNING LIGHT RELAY NO. 2 (POINT SIDE) → **HEAD (LH-UPR)** FUSE → HEADLIGHT HI-LH → HEADLIGHT HI-RH → **TERMINAL 4** OF DAYTIME RUNNING LIGHT RELAY NO. 3 → **TERMINAL 2** → **GROUND**, CAUSING THE HEADLIGHTS TO LIGHT UP AT HALF THEIR NORMAL BRIGHTNESS.

ONCE THE DAYTIME RUNNING LIGHT RELAY HAS BEEN ACTIVATED AND THE HEADLIGHTS LIGHT UP, THE HEADLIGHTS REMAIN ON EVEN IF THE PARKING BRAKE PEDAL IS ENGAGED AGAIN (PARKING BRAKE SW ON).

### 2. HEADLIGHT OPERATION

WHEN THE LIGHT CONTROL SW IS AT **HEAD** POSITION AND THE DIMMER SW AT **LOW** POSITION, CURRENT FLOWS FROM THE HEADLIGHT RELAY (COIL SIDE) TO **TERMINAL 6** OF THE INTEGRATION RELAY → **TERMINAL 7** → **TERMINAL 6** OF LIGHT CONTROL SW → **TERMINAL 16** → **GROUND**, ACTIVATING THE HEADLIGHT RELAY.

THIS CAUSES CURRENT TO FLOW FROM HEADLIGHT RELAY (POINT SIDE) TO THE **HEAD LWR** FUSE → HEADLIGHT LO → **GROUND**, CAUSING THE HEADLIGHTS TO LIGHT UP AT NORMAL BRIGHTNESS. SIMULTANEOUSLY, CURRENT FLOWS FROM THE **DRL** FUSE → DAYTIME RUNNING LIGHT RELAY NO. 3, NO. 4 (COIL SIDE) → **GROUND**, ACTIVATING RELAY NO. 3 AND NO. 4.

WHEN THE DIMMER SW IS AT **HIGH** POSITION, **TERMINAL 9** OF THE DIMMER SW OUTPUTS A SIGNAL TO **TERMINAL 16** OF THE DAYTIME RUNNING LIGHT RELAY TO ACTIVATE IT. THIS TURNS ON DAYTIME RUNNING LIGHT RELAY RELAY NO. 2 SO CURRENT FLOWS FROM DAYTIME RUNNING LIGHT RELAY NO. 2 (POINT SIDE) TO THE **HEAD (LH-UPR)** FUSE → HEADLIGHT HI LH → DAYTIME RUNNING LIGHT RELAY NO. 4 (POINT SIDE) → **GROUND**, AND FROM THE **HEAD (RH-UPR)** FUSE → DAYTIME RUNNING LIGHT RELAY NO. 3 (POINT SIDE) → HEADLIGHT HI RH → DAYTIME RUNNING LIGHT RELAY NO. 4 (POINT SIDE) → **GROUND**, CAUSING THE HEADLIGHTS TO OPERATE AT HI.

WHEN THE DIMMER SW IS AT **FLASH** POSITION, CURRENT FROM THE HEADLIGHT RELAY (COIL SIDE) FLOWS TO **TERMINAL 17** OF THE DIMMER SW → **TERMINAL 18** → **GROUND**, ACTIVATING THE RELAY. SIMULTANEOUSLY, CURRENT FROM THE HEADLIGHT RELAY (POINT SIDE) FLOWS TO HEADLIGHT LO, LIGHTING UP HEADLIGHT LO AND ACTIVATING DAYTIME RUNNING LIGHT RELAY NO. 3 AND NO. 4. THEN **TERMINAL 9** OF THE DIMMER SW OUTPUTS A SIGNAL TO **TERMINAL 16** OF THE DAYTIME RUNNING LIGHT RELAY, ACTIVATING THE DAYTIME RUNNING LIGHT RELAY SO THAT CURRENT FLOWS TO HEADLIGHT HI LIKE IT DOES FOR **HIGH** POSITION. THIS CAUSES ALL HEADLIGHTS TO LIGHT UP.

## SERVICE HINTS

### D 4 DAYTIME RUNNING LIGHT RELAY

15-GROUND : ALWAYS APPROX. 12 VOLTS

2-GROUND : APPROX. 12 VOLTS WITH THE IGNITION SW AT **ON** POSITION

13-GROUND : ALWAYS CONTINUITY

5-GROUND : APPROX. 12 VOLTS WITH THE DAYTIME RUNNING LIGHT SYSTEM

DOES NOT OPERATE OR LIGHT CONTROL SW AT **OFF** OR **TAIL** POSITION

(WITH THE CONNECTOR IS DISCONNECTED, ALWAYS APPROX. 12 VOLTS)

8-GROUND : CONTINUITY WITH THE PARKING BRAKE PEDAL DEPRESSED

## ○ : PARTS LOCATION

CODE	SEE PAGE	CODE	SEE PAGE	CODE	SEE PAGE
<b>B 1</b>	26	<b>H 3</b>	26	<b>J 2</b>	29
<b>C 9</b>	28	<b>H 4</b>	26	<b>J 7</b>	29
<b>C13</b>	28	<b>H 5</b>	26	<b>J 9</b>	29
<b>D 4</b>	28	<b>H 6</b>	26	<b>J11</b>	29
<b>D 7</b>	28	<b>H12</b>	29	<b>P 4</b>	29
<b>G 2</b>	26	<b>J 1</b>	27		

# HEADLIGHT (FOR CANADA)

## ○ : RELAY BLOCKS

CODE	SEE PAGE	RELAY BLOCKS (RELAY BLOCK LOCATION)
2	19	R/B NO. 2 (ENGINE COMPARTMENT LEFT)
6	24	R/B NO. 6 (LEFT KICK PANEL)

## ○ : JUNCTION BLOCK AND WIRE HARNESS CONNECTOR

CODE	SEE PAGE	JUNCTION BLOCK AND WIRE HARNESS (CONNECTOR LOCATION)
1B	20	COWL WIRE AND J/B NO. 1 (LEFT KICK PANEL)
1J		
3A	22	COWL WIRE AND J/B NO. 3 (BEHIND THE INSTRUMENT PANEL CENTER)
3D		
3E		

## □ : CONNECTOR JOINING WIRE HARNESS AND WIRE HARNESS

CODE	SEE PAGE	JOINING WIRE HARNESS AND WIRE HARNESS (CONNECTOR LOCATION)
EA1	34	ENGINE ROOM MAIN WIRE AND R/B NO. 2 WIRE (INSIDE OF R/B NO. 2)
EB1	34	COWL WIRE AND R/B NO. 2 WIRE (INSIDE OF R/B NO. 2)
EB2		
EC1	34	COWL WIRE AND ENGINE ROOM MAIN WIRE (INSIDE OF R/B NO. 2)
ED1	34	ENGINE ROOM MAIN WIRE AND ENGINE NO. 4 WIRE (NEAR THE R/B NO. 2)

## ▽ : GROUND POINTS

CODE	SEE PAGE	GROUND POINTS LOCATION
EA	34	FRONT SIDE OF RIGHT FENDER
EB	34	FRONT SIDE OF LEFT FENDER
IE	36	LEFT KICK PANEL
IF	36	BEHIND COMBINATION METER

## ○ : SPLICE POINTS

CODE	SEE PAGE	WIRE HARNESS WITH SPLICE POINTS	CODE	SEE PAGE	WIRE HARNESS WITH SPLICE POINTS
E 8	34	ENGINE ROOM MAIN WIRE	I26	38	COWL WIRE

B 1 GRAY



C 9

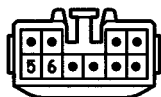

C13

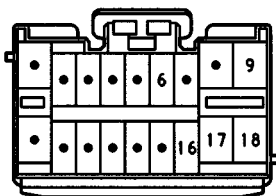

D 4 GRAY

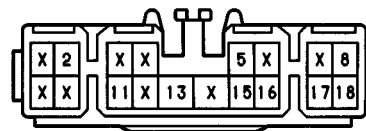

D 7 BLACK



G 2 GRAY

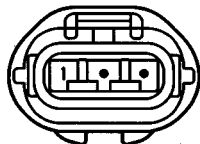

H 3, H 4 BLACK



H 5, H 6 BROWN



I12

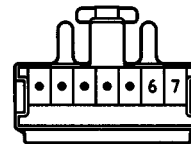

J 1



(HINT:SEE PAGE 7)

J 2



(HINT:SEE PAGE 7)

J 7 GRAY

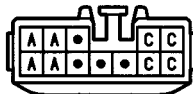

(HINT:SEE PAGE 7)

J 9 GRAY

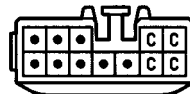

(HINT:SEE PAGE 7)

J11

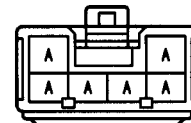

(HINT:SEE PAGE 7)

P 4 GRAY



---

# FOG LIGHT

FROM POWER SOURCE SYSTEM (SEE PAGE 58)

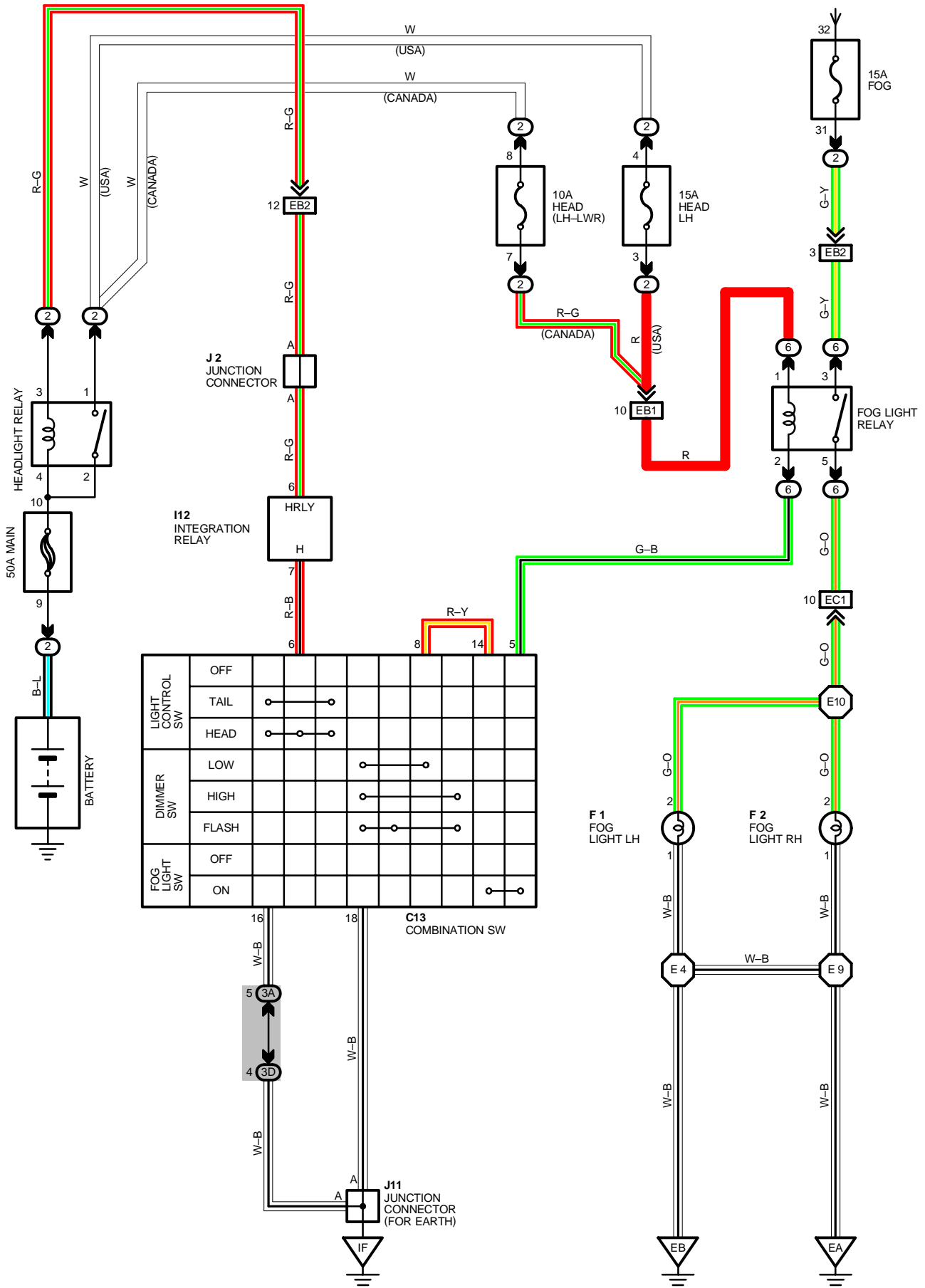

## SERVICE HINTS

### FOG LIGHT RELAY

(6) 3- (6) 5 : CLOSED WITH LIGHT CONTROL SW AT **HEAD** POSITION, DIMMER SW AT **LOW** POSITION AND FOG LIGHT SW **ON** POSITION

### ○ : PARTS LOCATION

CODE	SEE PAGE	CODE	SEE PAGE	CODE	SEE PAGE
C13	28	F 2	26	J 2	29
F 1	26	I12	29	J11	29

### ○ : RELAY BLOCKS

CODE	SEE PAGE	RELAY BLOCKS (RELAY BLOCK LOCATION)
2	19	R/B NO. 2 (ENGINE COMPARTMENT LEFT)
6	24	R/B NO. 6 (LEFT KICK PANEL)

### ○ : JUNCTION BLOCK AND WIRE HARNESS CONNECTOR

CODE	SEE PAGE	JUNCTION BLOCK AND WIRE HARNESS (CONNECTOR LOCATION)
3A	22	COWL WIRE AND J/B NO. 3 (BEHIND THE INSTRUMENT PANEL CENTER)
3D		

### □ : CONNECTOR JOINING WIRE HARNESS AND WIRE HARNESS

CODE	SEE PAGE	JOINING WIRE HARNESS AND WIRE HARNESS (CONNECTOR LOCATION)
EB1	34	COWL WIRE AND R/B NO. 2 WIRE (INSIDE OF R/B NO. 2)
EB2		
EC1	34	COWL WIRE AND ENGINE ROOM MAIN WIRE (INSIDE OF R/B NO. 2)

### ▽ : GROUND POINTS

CODE	SEE PAGE	GROUND POINTS LOCATION
EA	34	FRONT SIDE OF RIGHT FENDER
EB	34	FRONT SIDE OF LEFT FENDER
IF	36	BEHIND COMBINATION METER

### ○ : SPLICE POINTS

CODE	SEE PAGE	WIRE HARNESS WITH SPLICE POINTS	CODE	SEE PAGE	WIRE HARNESS WITH SPLICE POINTS
E 4	34	ENGINE ROOM MAIN WIRE	E10	34	ENGINE ROOM MAIN WIRE
E 9					

C13

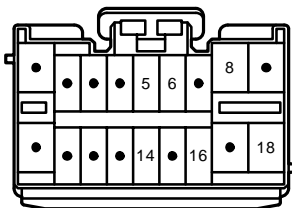

F 1 BLACK



F 2 BLACK



I12

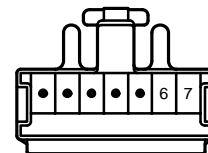

J 2

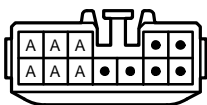

(HINT : SEE PAGE 7)

J11

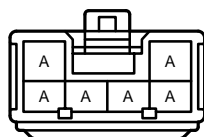

(HINT : SEE PAGE 7)

# TURN SIGNAL AND HAZARD WARNING LIGHT

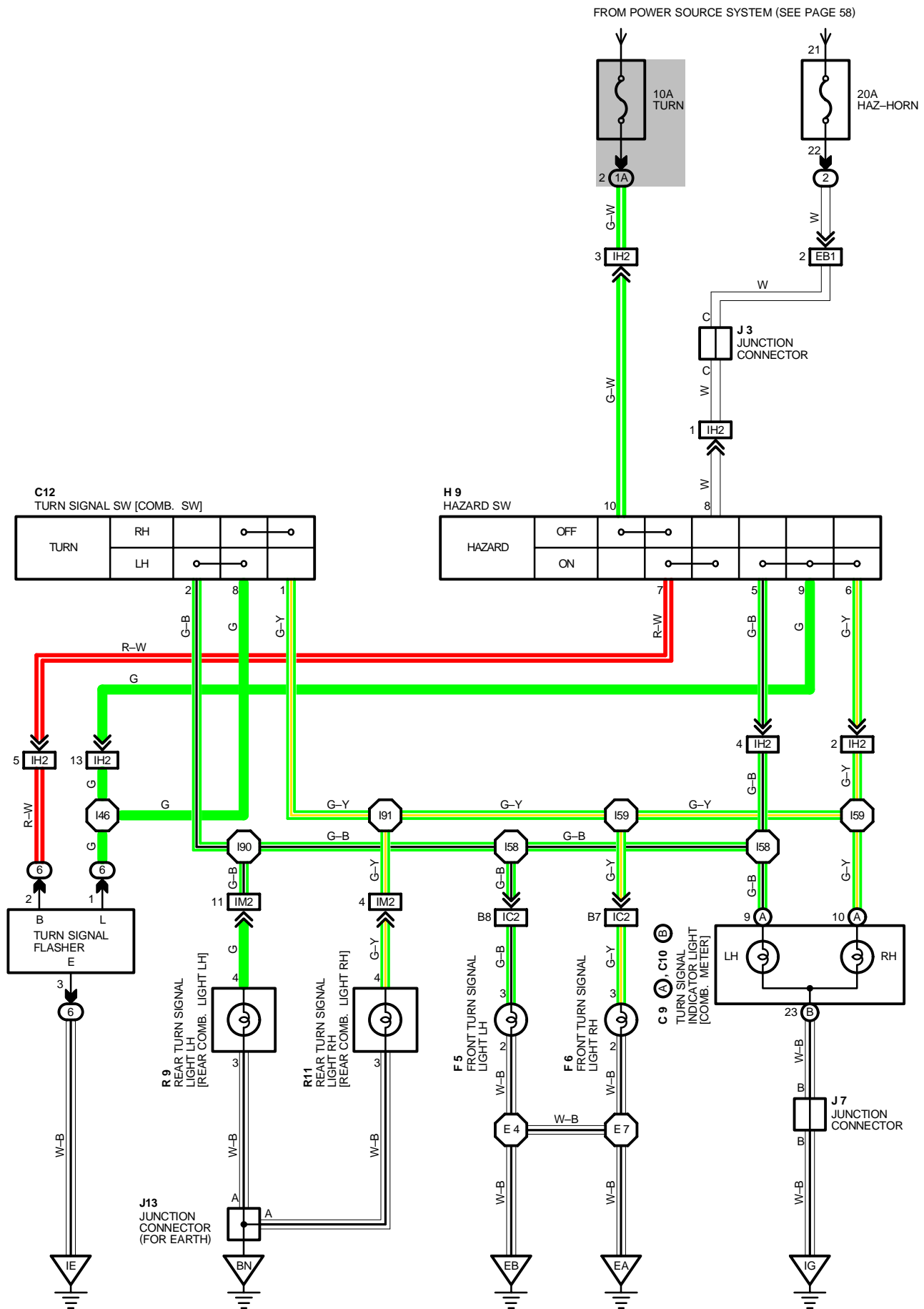

## SERVICE HINTS

### TURN SIGNAL FLASHER

- (6) 1 – GROUND : CHANGES FROM APPROX. 12 VOLTS TO 0 VOLTS WITH IGNITION SW ON AND TURN SIGNAL SW LEFT OR RIGHT, OR WITH HAZARD SW ON
- (6) 2 – GROUND : APPROX. 12 VOLTS WITH IGNITION SW ON OR HAZARD SW ON
- (6) 3 – GROUND : ALWAYS CONTINUITY

### : PARTS LOCATION

CODE	SEE PAGE	CODE	SEE PAGE	CODE	SEE PAGE
C 9	A 28	F6	26	J13	30
C10	B 28	H 9	29	R 9	31
C12	28	J 3	29	R11	31
F 5	26	J 7	29		

### : RELAY BLOCKS

CODE	SEE PAGE	RELAY BLOCKS (RELAY BLOCK LOCATION)
2	19	R/B NO. 2 (ENGINE COMPARTMENT LEFT)
6	24	R/B NO. 6 (LEFT KICK PANEL)

### : JUNCTION BLOCK AND WIRE HARNESS CONNECTOR

CODE	SEE PAGE	JUNCTION BLOCK AND WIRE HARNESS (CONNECTOR LOCATION)
1A	20	COWL WIRE AND J/B NO. 1 (LEFT KICK PANEL)

### : CONNECTOR JOINING WIRE HARNESS AND WIRE HARNESS

CODE	SEE PAGE	JOINING WIRE HARNESS AND WIRE HARNESS (CONNECTOR LOCATION)
EB1	34	COWL WIRE AND R/B NO. 2 WIRE (INSIDE OF R/B NO. 2)
IC2	36	ENGINE ROOM MAIN WIRE AND COWL WIRE (UNDER THE GLOVE BOX)
IH2	36	COWL WIRE AND INSTRUMENT PANEL WIRE (BEHIND GLOVE BOX)
IM2	38	COWL WIRE AND FLOOR NO. 1 WIRE (RIGHT KICK PANEL)

### : GROUND POINTS

CODE	SEE PAGE	GROUND POINTS LOCATION
EA	34	FRONT SIDE OF RIGHT FENDER
EB	34	FRONT SIDE OF LEFT FENDER
IE	36	LEFT KICK PANEL
IG	36	BEHIND GLOVE BOX
BN	40	LUGGAGE ROOM RIGHT

### : SPLICE POINTS

CODE	SEE PAGE	WIRE HARNESS WITH SPLICE POINTS	CODE	SEE PAGE	WIRE HARNESS WITH SPLICE POINTS
E 4	34	ENGINE ROOM MAIN WIRE	I59	38	COWL WIRE
E 7			I90		
I46	38	COWL WIRE	I91		
I58					

# TURN SIGNAL AND HAZARD WARNING LIGHT

C 9 (A)



C10 (B) ORANGE

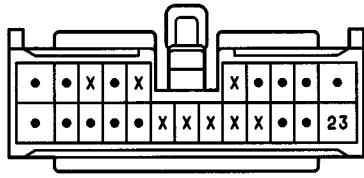

C12 BLACK

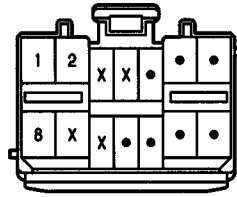

F 5 GRAY

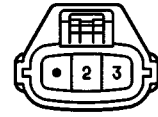

F 6 GRAY



H 9 BLACK

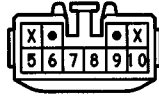

J 3 BLACK

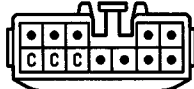

(HINT:SEE PAGE 7)

J 7 GRAY

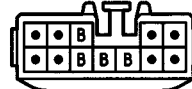

(HINT:SEE PAGE 7)

J13

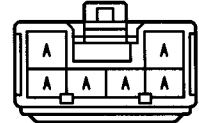

(HINT:SEE PAGE 7)

R 9

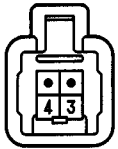

R11

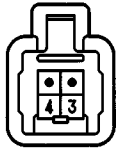



---

# INTERIOR LIGHT

FROM POWER SOURCE SYSTEM (SEE PAGE 58)

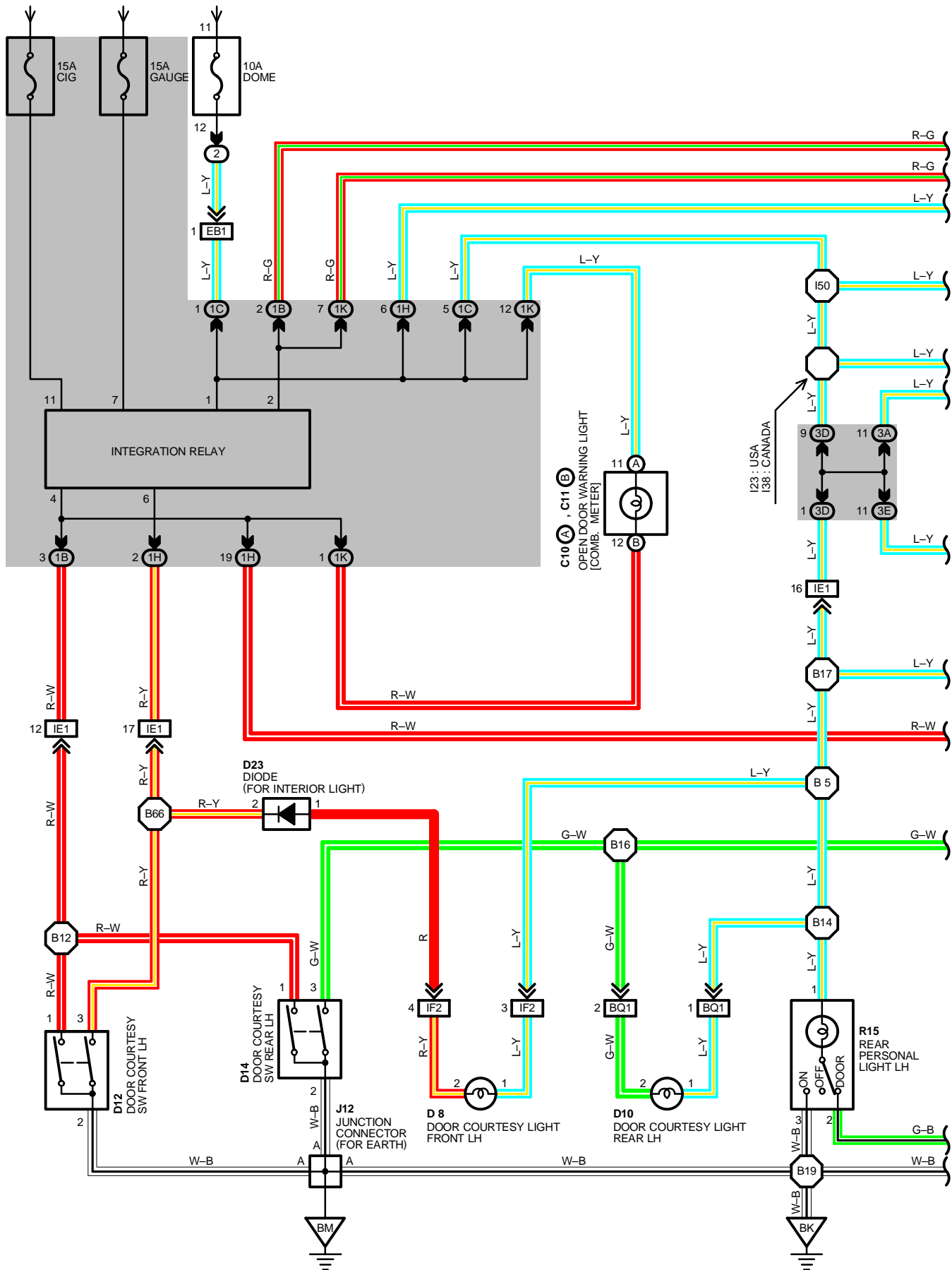

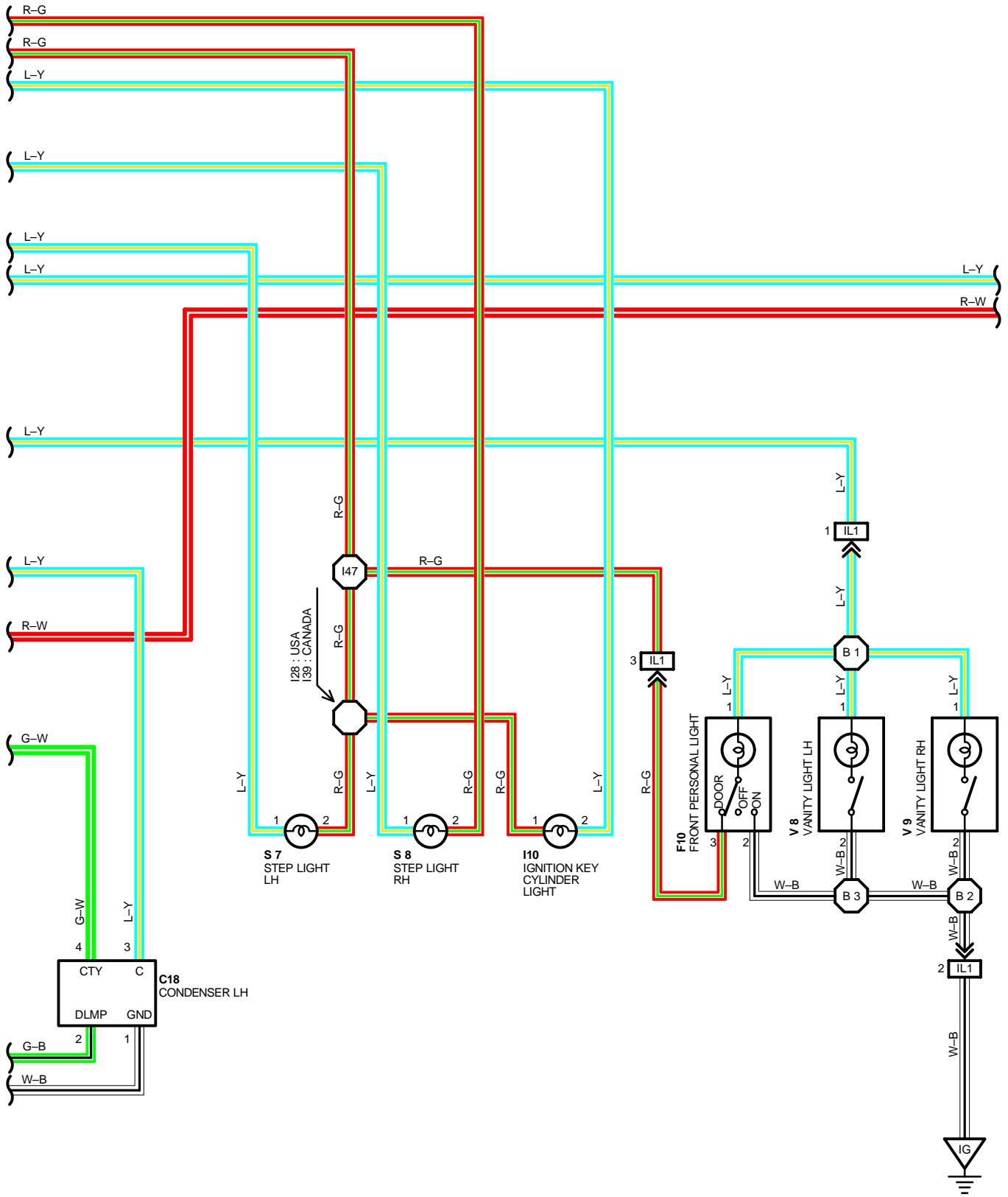

# INTERIOR LIGHT

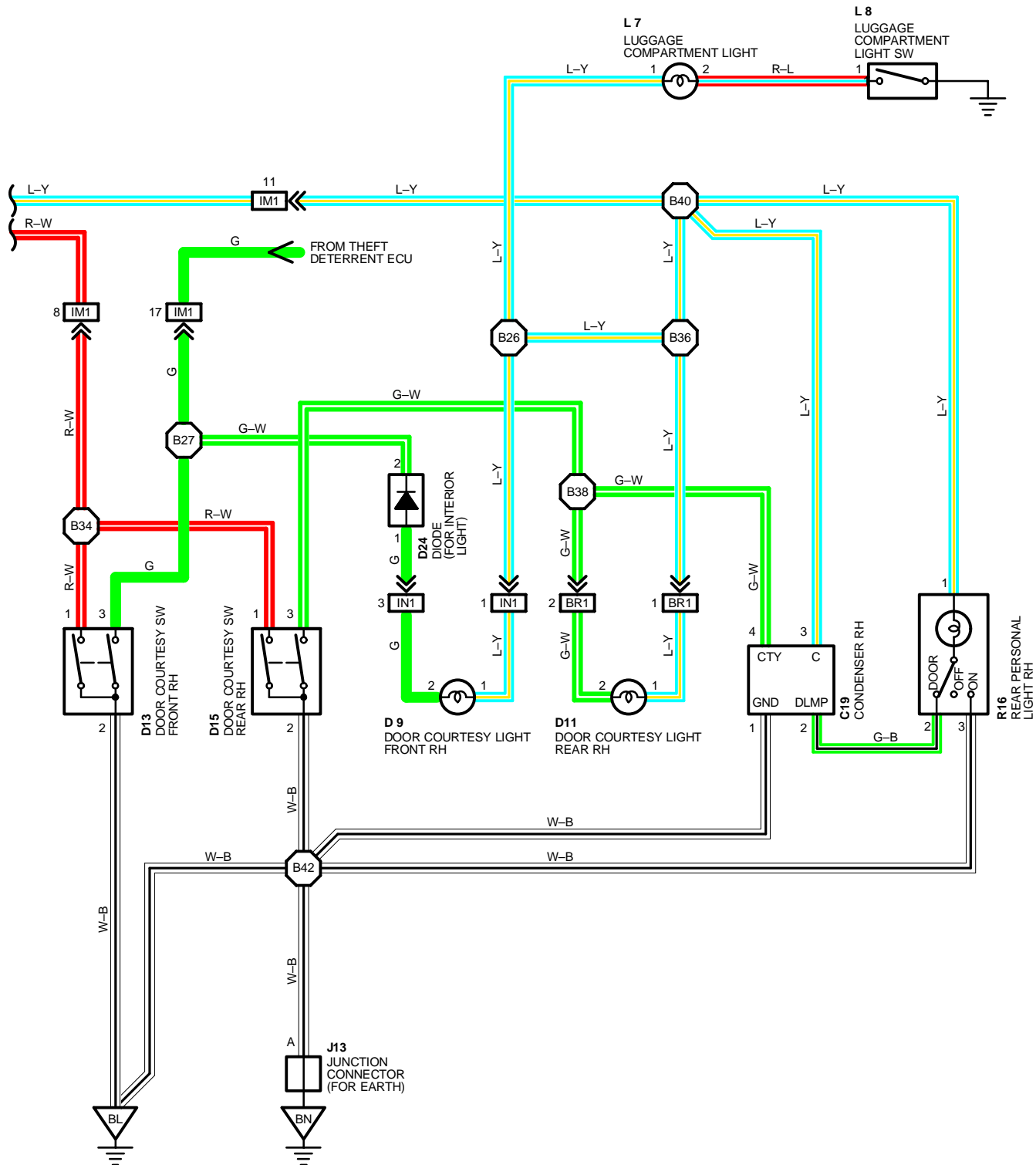

## SERVICE HINTS

### INTEGRATION RELAY

- 1-GROUND : ALWAYS APPROX. 12 VOLTS
- 4-GROUND : CONTINUITY WITH EACH DOOR (FRONT LH AND RH, REAR LH AND RH) OPEN
- 6-GROUND : CONTINUITY WITH FRONT LH DOOR OPEN

### D12, D13, D14, D15 DOOR COURTESY SW FRONT LH, RH, REAR LH, RH

- 1, 3-GROUND : CLOSED WITH DOOR OPEN

### L 8 LUGGAGE COMPARTMENT LIGHT SW

- 1-GROUND : CLOSED WITH LUGGAGE COMPARTMENT DOOR OPEN

## ○ : PARTS LOCATION

CODE	SEE PAGE	CODE	SEE PAGE	CODE	SEE PAGE
C10	A 28	D13	30	L 7	30
C11	B 28	D14	30	L 8	30
C18	30	D15	30	R15	31
C19	30	D23	28	R16	31
D 8	30	D24	28	S 7	29
D 9	30	F10	30	S 8	29
D10	30	I10	29	V 8	31
D11	30	J12	30	V 9	31
D12	30	J13	30		

## ○ : RELAY BLOCKS

CODE	SEE PAGE	RELAY BLOCKS (RELAY BLOCK LOCATION)
2	19	R/B NO. 2 (ENGINE COMPARTMENT LEFT)

## ○ : JUNCTION BLOCK AND WIRE HARNESS CONNECTOR

CODE	SEE PAGE	JUNCTION BLOCK AND WIRE HARNESS (CONNECTOR LOCATION)
1B	20	COWL WIRE AND J/B NO. 1 (LEFT KICK PANEL)
1C		
1H		
1K		
3A	22	COWL WIRE AND J/B NO. 3 (BEHIND THE INSTRUMENT PANEL CENTER)
3D		
3E		

## □ : CONNECTOR JOINING WIRE HARNESS AND WIRE HARNESS

CODE	SEE PAGE	JOINING WIRE HARNESS AND WIRE HARNESS (CONNECTOR LOCATION)
EB1	34	COWL WIRE AND R/B NO. 2 WIRE (INSIDE OF R/B NO. 2)
IE1	36	COWL WIRE AND FLOOR NO. 2 WIRE (LEFT KICK PANEL)
IF2	36	FRONT DOOR LH WIRE AND FLOOR NO. 2 WIRE (LEFT KICK PANEL)
IL1	38	COWL WIRE AND ROOF WIRE (BEHIND GLOVE BOX)
IM1	38	COWL WIRE AND FLOOR NO. 1 WIRE (RIGHT KICK PANEL)
IN1	38	FRONT DOOR RH WIRE AND FLOOR NO. 1 WIRE (RIGHT KICK PANEL)
BQ1	40	REAR DOOR LH WIRE AND FLOOR NO. 2 WIRE (LEFT CENTER PILLAR)
BR1	40	REAR DOOR RH WIRE AND FLOOR NO. 1 WIRE (RIGHT CENTER PILLAR)

## ▽ : GROUND POINTS

CODE	SEE PAGE	GROUND POINTS LOCATION
IG	36	BEHIND GLOVE BOX
BK	40	UNDER THE FRONT SEAT LH
BL	40	UNDER THE FRONT SEAT RH
BM	40	LUGGAGE ROOM LEFT
BN	40	LUGGAGE ROOM RIGHT

# INTERIOR LIGHT

 : SPLICE POINTS

CODE	SEE PAGE	WIRE HARNESS WITH SPLICE POINTS	CODE	SEE PAGE	WIRE HARNESS WITH SPLICE POINTS
I23	38	COWL WIRE	B16	40	FLOOR NO. 2 WIRE
I28			B17		
I38			B19		
I39			B26		
I47			B27		
I50			B34		
B 1	40	ROOF WIRE	B36	40	FLOOR NO. 1 WIRE
B 2			B38		
B 3			B40		
B 5			B42		
B12	40	FRONT NO. 2 WIRE	B66	40	FLOOR NO. 2 WIRE
B14					

C10 (A) ORANGE

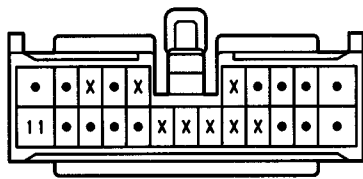

C11 (B) GRAY

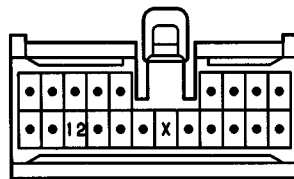

C18

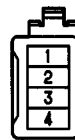

C19

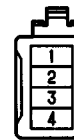

D 8 GRAY



D 9 GRAY



D10 GRAY



D11 GRAY



D12 BLACK

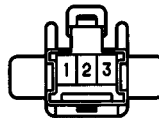

D13 BLACK

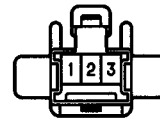

D14 BLACK

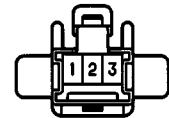

D15 BLACK

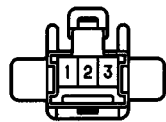

D23 BLACK



D24 BLACK



F10

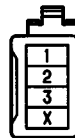

I10



J12

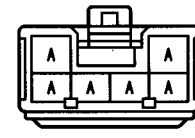

(HINT:SEE PAGE 7)

J13

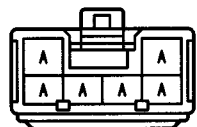

(HINT:SEE PAGE 7)

L 7 GRAY



L 8 GRAY



R15



R16

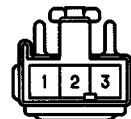

S 7 BLACK



S 8 BLACK



V 8

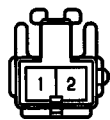

V 9



# ILLUMINATION

A10 ORANGE



A15



A29, A30



C 7



C 8 BLACK

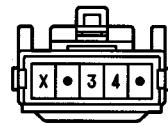

C10 (B) ORANGE

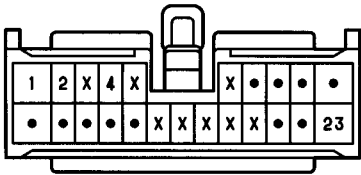

C11 (A) GRAY

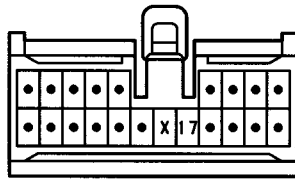

C13

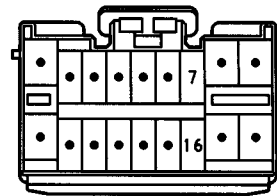

E 6



G 3 GRAY



G 4 BLACK



H 9 BLACK



I12

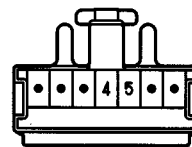

J 3 BLACK

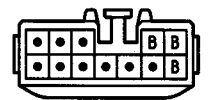

(HINT:SEE PAGE 7)

J 6 GRAY

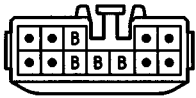

(HINT:SEE PAGE 7)

J 7 GRAY

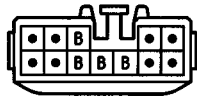

(HINT:SEE PAGE 7)

J10 GRAY

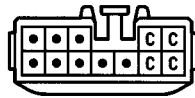

(HINT:SEE PAGE 7)

J11, J12

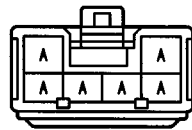

(HINT:SEE PAGE 7)

R 3 BLUE



R 6 GRAY



R 8



S 5



# ILLUMINATION

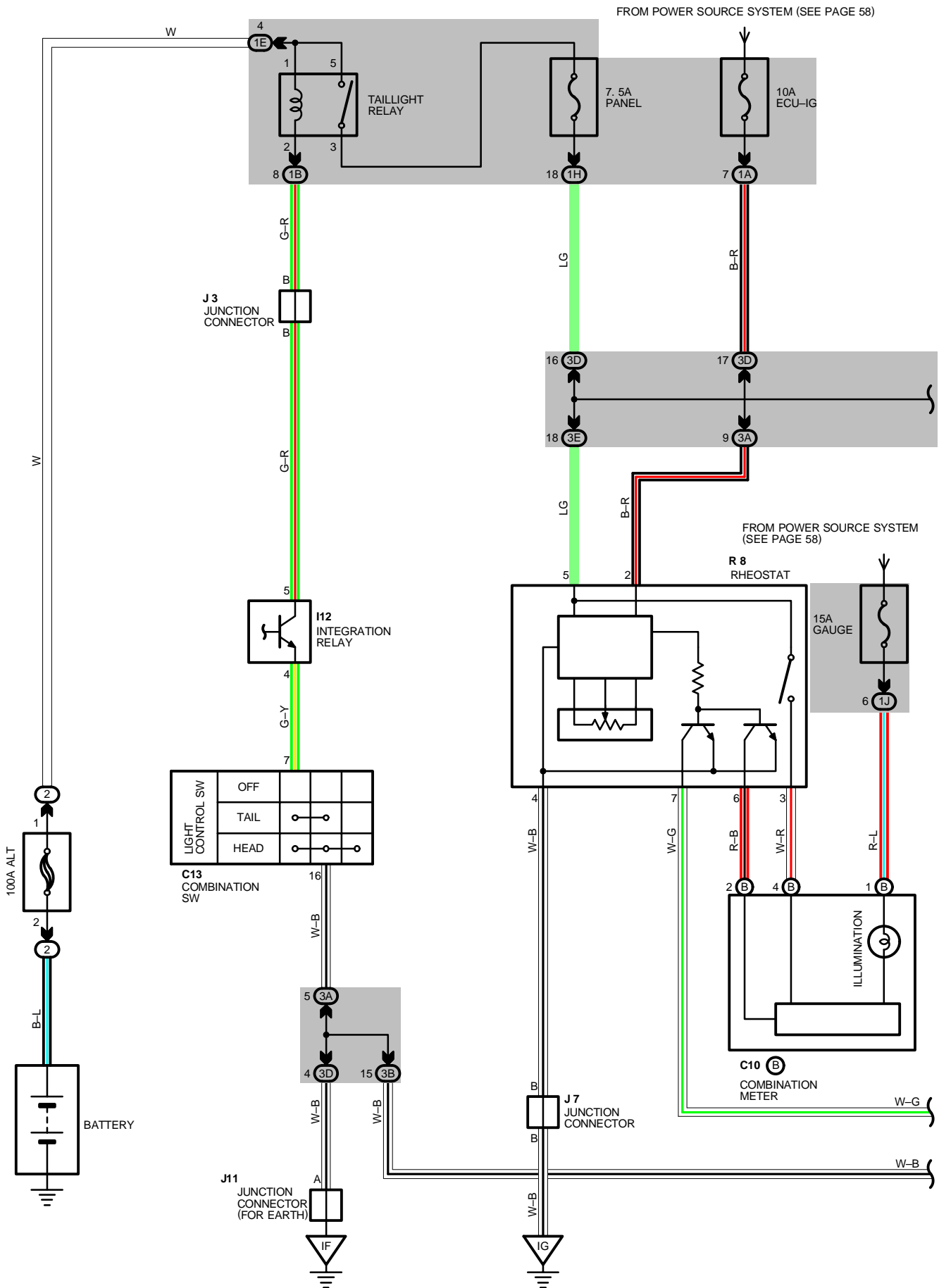



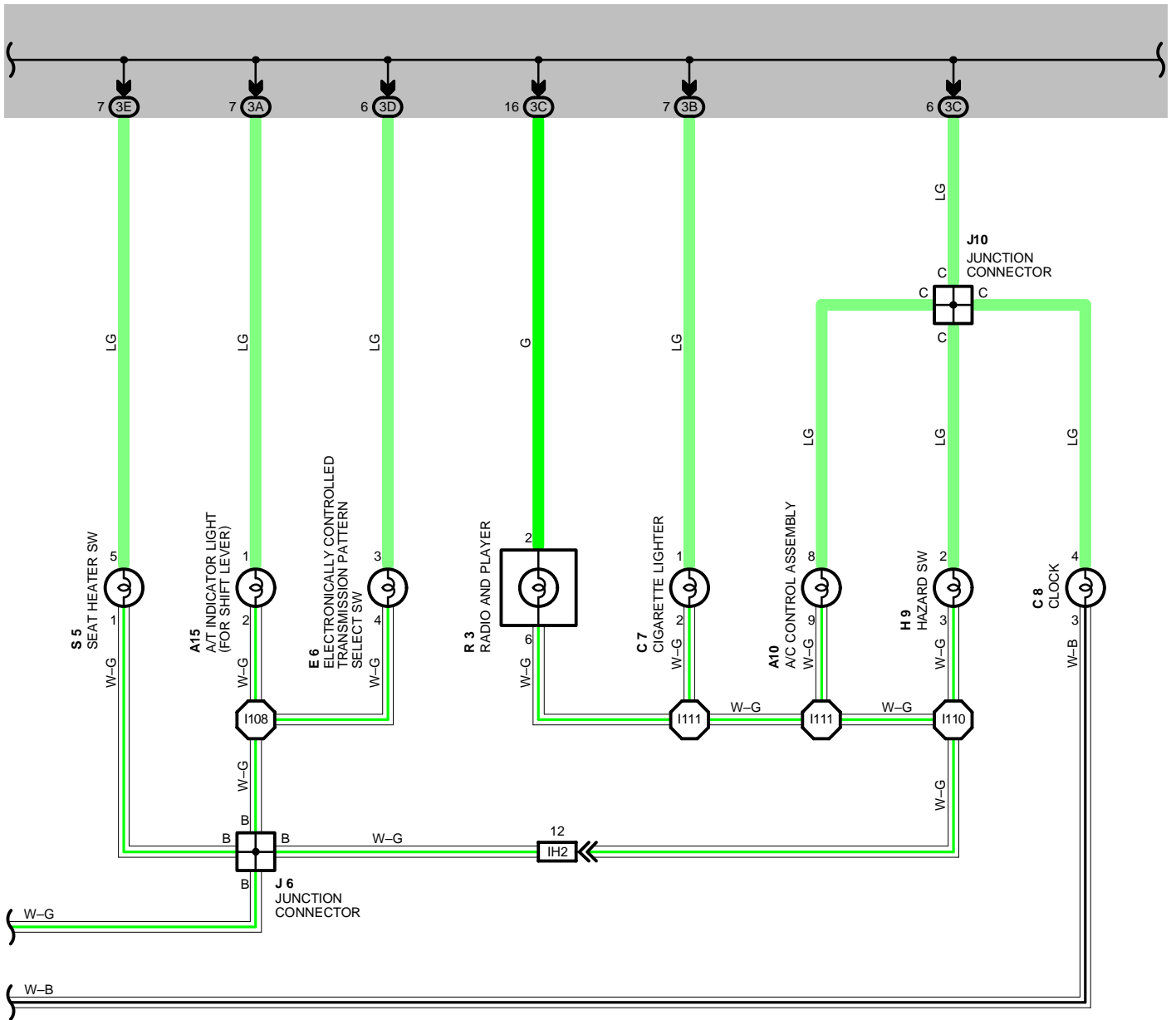

# ILLUMINATION

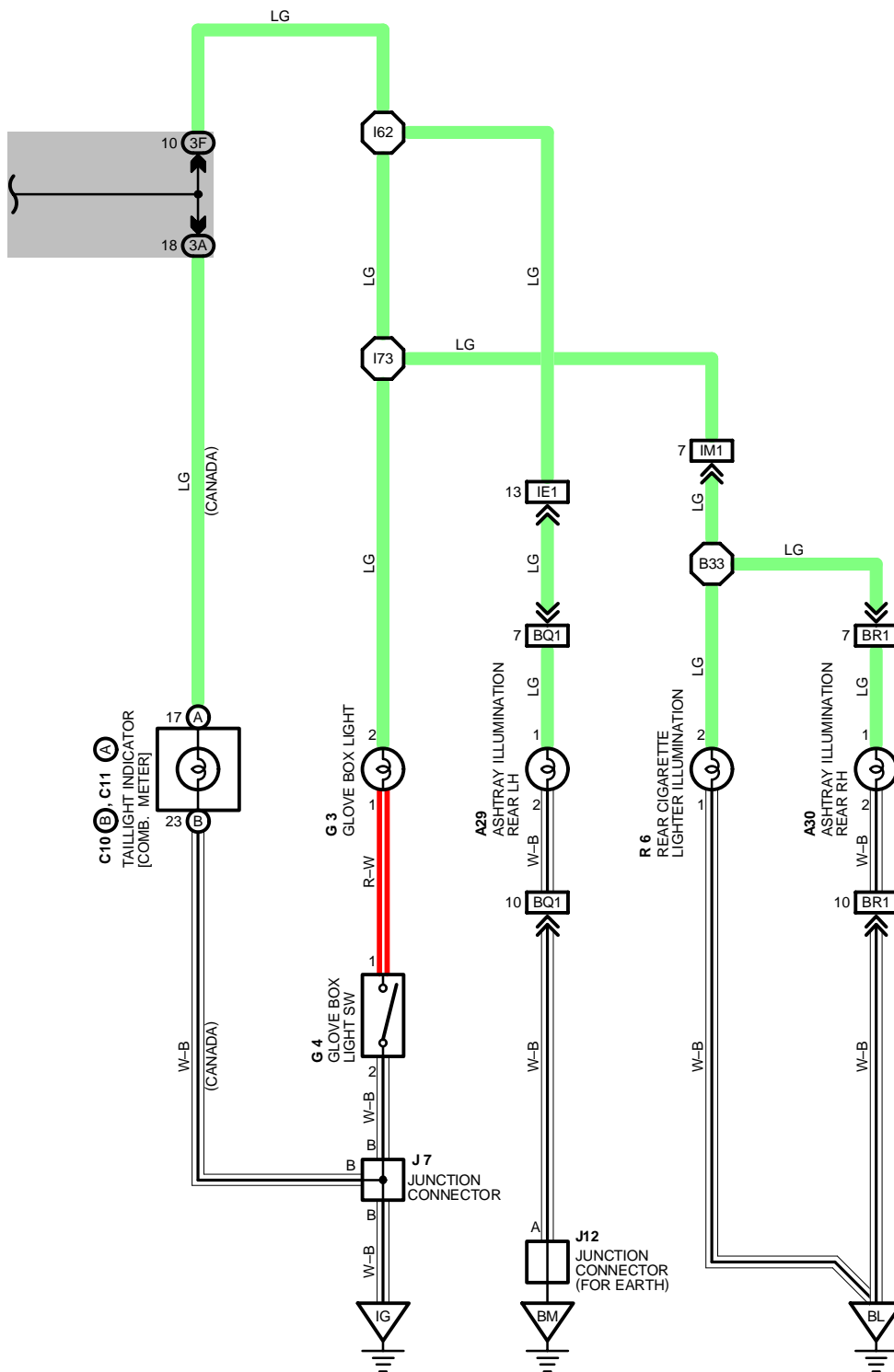

## SERVICE HINTS

### TAILLIGHT RELAY

5-3 : CLOSED WITH LIGHT CONTROL SW AT **TAIL** OR **HEAD** POSITION

### C13 LIGHT CONTROL SW [COMB. SW]

7-16 : CLOSED WITH LIGHT CONTROL SW AT **TAIL** OR **HEAD** POSITION

## ○ : PARTS LOCATION

CODE	SEE PAGE	CODE	SEE PAGE	CODE	SEE PAGE
A10	28	C13	28	J 7	29
A15	28	E 6	28	J10	29
A29	30	G 3	28	J11	29
A30	30	G 4	28	J12	30
C 7	28	H 9	29	R 3	29
C 8	28	I12	29	R 6	29
C10	B 28	J 3	29	R 8	29
C11	A 28	J 6	29	S 5	29

## ○ : RELAY BLOCKS

CODE	SEE PAGE	RELAY BLOCKS (RELAY BLOCK LOCATION)
2	19	R/B NO. 2 (ENGINE COMPARTMENT LEFT)

## ○ : JUNCTION BLOCK AND WIRE HARNESS CONNECTOR

CODE	SEE PAGE	JUNCTION BLOCK AND WIRE HARNESS (CONNECTOR LOCATION)
1A	20	COWL WIRE AND J/B NO. 1 (LEFT KICK PANEL)
1B		
1E		
1H		
1J		
3A	22	COWL WIRE AND J/B NO. 3 (BEHIND THE INSTRUMENT PANEL CENTER)
3B	22	INSTRUMENT PANEL WIRE AND J/B NO. 3 (BEHIND THE INSTRUMENT PANEL CENTER)
3C		
3D	22	COWL WIRE AND J/B NO. 3 (BEHIND THE INSTRUMENT PANEL CENTER)
3E		
3F		

## □ : CONNECTOR JOINING WIRE HARNESS AND WIRE HARNESS

CODE	SEE PAGE	JOINING WIRE HARNESS AND WIRE HARNESS (CONNECTOR LOCATION)
IE1	36	COWL WIRE AND FLOOR NO. 2 WIRE (LEFT KICK PANEL)
IH2	36	COWL WIRE AND INSTRUMENT PANEL WIRE (BEHIND GLOVE BOX)
IM1	38	COWL WIRE AND FLOOR NO. 1 WIRE (RIGHT KICK PANEL)
BQ1	40	REAR DOOR LH WIRE AND FLOOR NO. 2 WIRE (LEFT CENTER PILLAR)
BR1	40	REAR DOOR RH WIRE AND FLOOR NO. 1 WIRE (RIGHT CENTER PILLAR)

## ▽ : GROUND POINTS

CODE	SEE PAGE	GROUND POINTS LOCATION
IF	36	BEHIND COMBINATION METER
IG	36	BEHIND GLOVE BOX
BL	40	UNDER THE FRONT SEAT RH
BM	40	LUGGAGE ROOM LEFT

## ○ : SPLICE POINTS

CODE	SEE PAGE	WIRE HARNESS WITH SPLICE POINTS	CODE	SEE PAGE	WIRE HARNESS WITH SPLICE POINTS
I62	38	COWL WIRE	I110	38	INSTRUMENT PANEL WIRE
I73			I111		
I108			B33	40	FLOOR NO. 1 WIRE

# TAILLIGHT

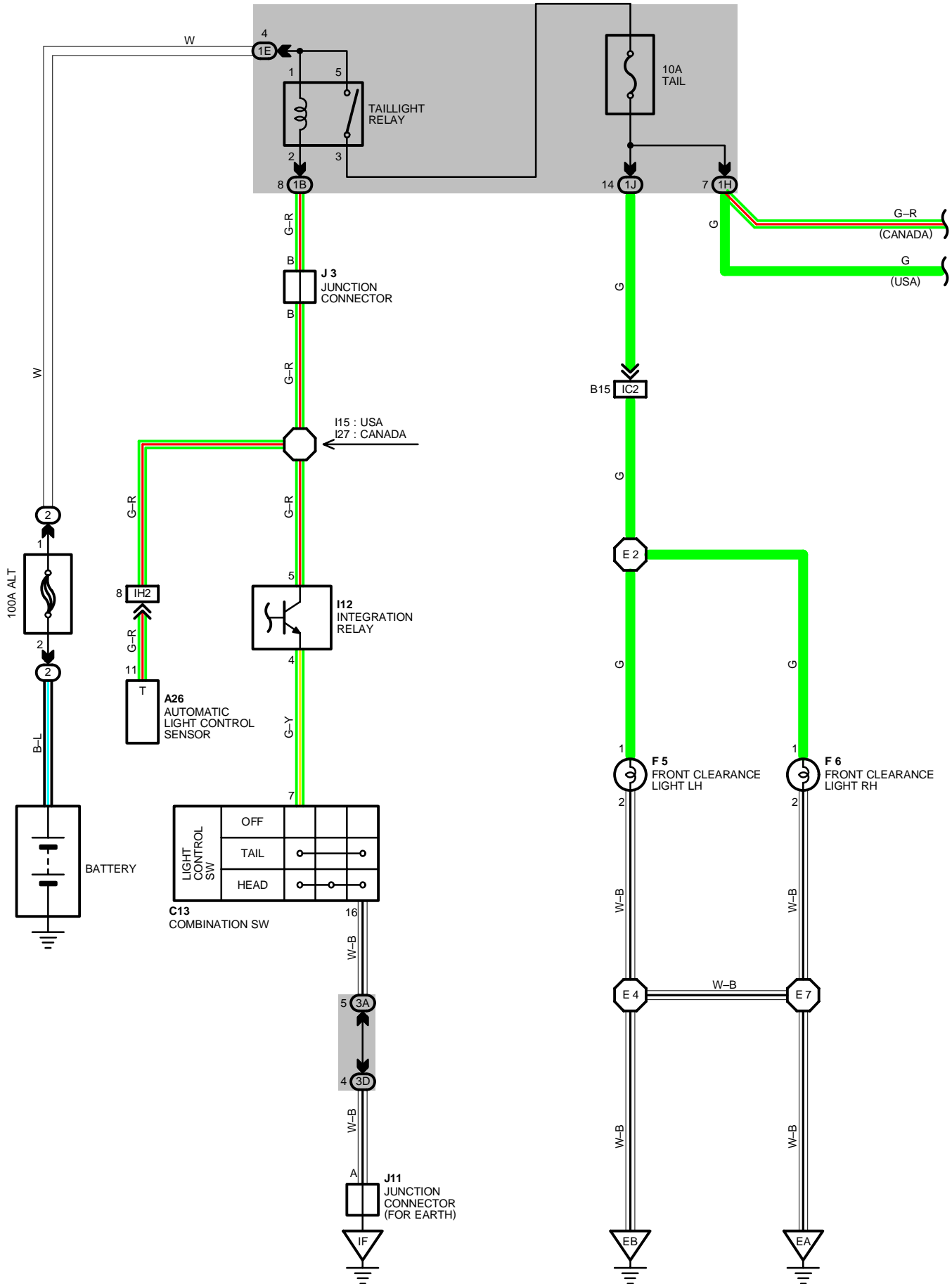

FROM POWER SOURCE SYSTEM (SEE PAGE 58)

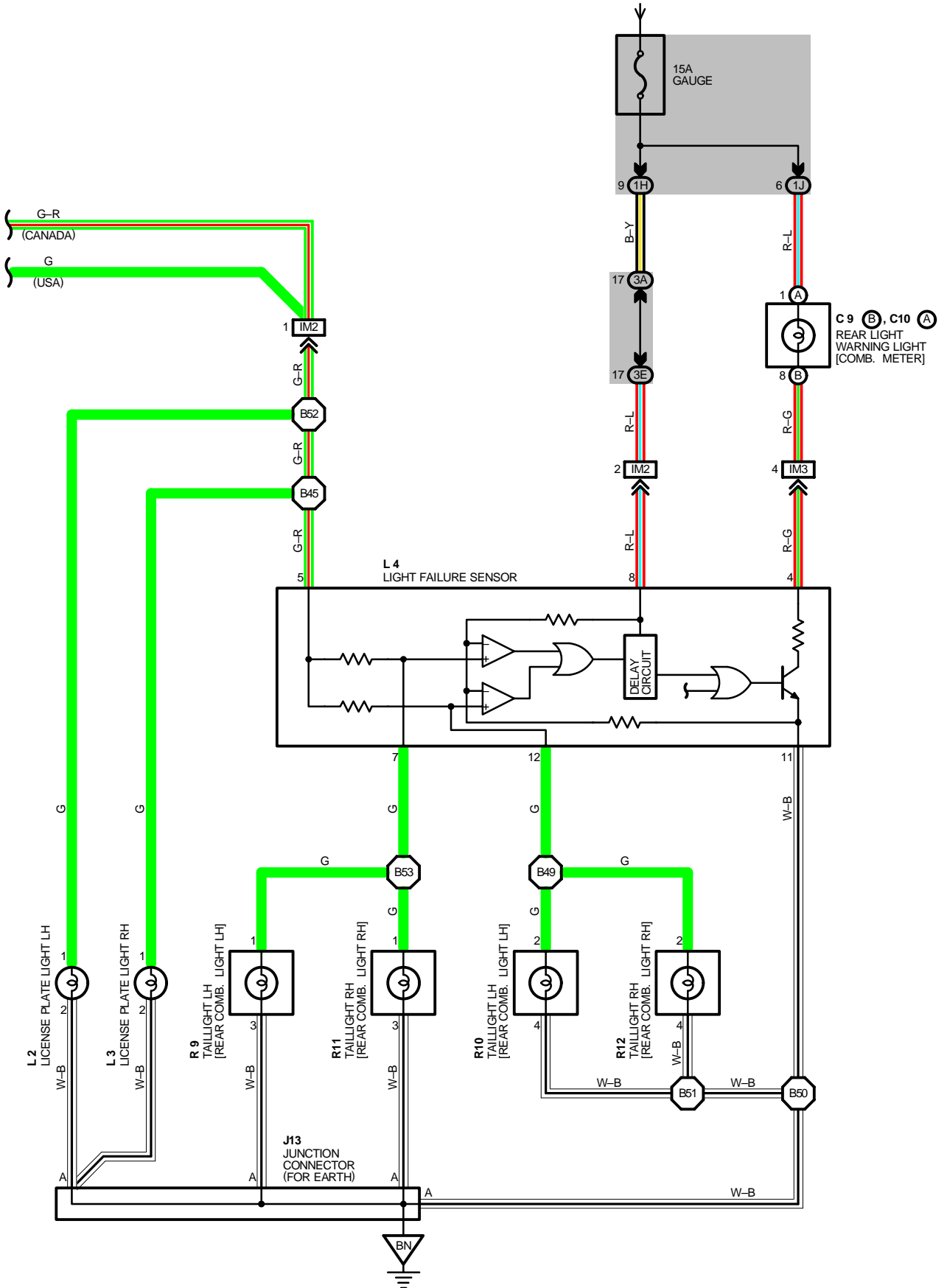

# TAILLIGHT

## SYSTEM OUTLINE

WHEN THE LIGHT CONTROL SW IS TURNED TO **TAIL** OR **HEAD** POSITION. THE CURRENT FLOWS TO **TERMINAL 5** OF LIGHT FAILURE SENSOR THROUGH THE **TAIL** FUSE.

WHEN THE IGNITION SW IS TURNED ON, THE CURRENT FLOWS FROM THE **GAUGE** FUSE TO **TERMINAL 8** OF THE LIGHT FAILURE SENSOR, AND ALSO FLOWS THROUGH THE REAR LIGHT WARNING LIGHT TO **TERMINAL 4** OF THE LIGHT FAILURE SENSOR.

### TAILLIGHT DISCONNECTION WARNING

WITH THE IGNITION SW ON AND THE LIGHT CONTROL SW TURNED TO **TAIL** OR **HEAD** POSITION. IF THE TAILLIGHT CIRCUIT IS OPEN, THE LIGHT FAILURE SENSOR DETECTS THE FAILURE BY THE CHANGE IN CURRENT FLOWING FROM **TERMINAL 5** OF THE LIGHT FAILURE SENSOR TO **TERMINAL 7, 12** AND THE WARNING CIRCUIT OF THE LIGHT FAILURE SENSOR IS ACTIVATED.

AS A RESULT, THE CURRENT FLOWS FROM **TERMINAL 4** OF THE LIGHT FAILURE SENSOR → **TERMINAL 11** → **GROUND** AND TURNS THE REAR LIGHT WARNING LIGHT ON, WHICH REMAINS ON UNTIL THE LIGHT CONTROL SW IS TURNED OFF.

## SERVICE HINTS

### TAILLIGHT RELAY

5-3: CLOSED WITH LIGHT CONTROL SW AT **TAIL** OR **HEAD** POSITION

### L 4 LIGHT FAILURE SENSOR

4, 8-GROUND: APPROX. **12** VOLTS WITH IGNITION SW AT **ON** POSITION

5-GROUND: APPROX. **12** VOLTS WITH LIGHT CONTROL SW AT **TAIL** OR **HEAD** POSITION

11-GROUND : ALWAYS CONTINUITY

## ○ : PARTS LOCATION

CODE	SEE PAGE	CODE	SEE PAGE	CODE	SEE PAGE
A26	28	I12	29	L 4	30
C 9	B 28	J 3	29	R 9	31
C10	A 28	J11	29	R10	31
C13	28	J13	30	R11	31
F 5	26	L 2	30	R12	31
F 6	26	L 3	30		

## ○ : RELAY BLOCKS

CODE	SEE PAGE	RELAY BLOCKS (RELAY BLOCK LOCATION)
2	19	R/B NO. 2 (ENGINE COMPARTMENT LEFT)

## ○ : JUNCTION BLOCK AND WIRE HARNESS CONNECTOR

CODE	SEE PAGE	JUNCTION BLOCK AND WIRE HARNESS (CONNECTOR LOCATION)
1B	20	COWL WIRE AND J/B NO. 1 (LEFT KICK PANEL)
1E		
1H		
1J		
3A	22	COWL WIRE AND J/B NO. 3 (BEHIND THE INSTRUMENT PANEL CENTER)
3D		
3E		

## □ : CONNECTOR JOINING WIRE HARNESS AND WIRE HARNESS

CODE	SEE PAGE	JOINING WIRE HARNESS AND WIRE HARNESS (CONNECTOR LOCATION)
IC2	36	ENGINE ROOM MAIN WIRE AND COWL WIRE (UNDER THE GLOVE BOX)
IH2	36	COWL WIRE AND INSTRUMENT PANEL WIRE (BEHIND GLOVE BOX)
IM2	38	COWL WIRE AND FLOOR NO. 1 WIRE (RIGHT KICK PANEL)
IM3		

## ▽ : GROUND POINTS

CODE	SEE PAGE	GROUND POINTS LOCATION
EA	34	FRONT SIDE OF RIGHT FENDER
EB	34	FRONT SIDE OF LEFT FENDER
IF	36	BEHIND COMBINATION METER
BN	40	LUGGAGE ROOM RIGHT



**: SPLICE POINTS**

CODE	SEE PAGE	WIRE HARNESS WITH SPLICE POINTS	CODE	SEE PAGE	WIRE HARNESS WITH SPLICE POINTS
E 2	34	ENGINE ROOM MAIN WIRE	B49	40	FLOOR NO. 1 WIRE
E 4			B50		
E 7			B51		
I15	38	COWL WIRE	B52		
I27			B53		
B45	40	FLOOR NO. 1 WIRE			

**A26**

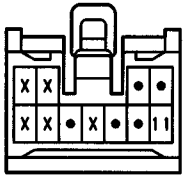

**C 9 (B)**



**C10 (A) ORANGE**

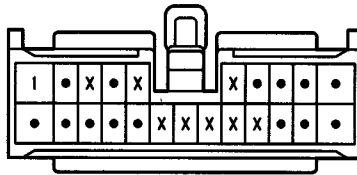

**C13**

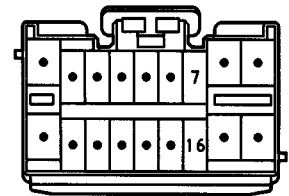

**F 5, F 6 GRAY**

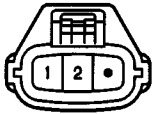

**I12**

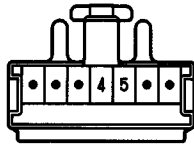

**J 3 BLACK**



(HINT:SEE PAGE 7)

**J11**

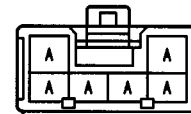

(HINT:SEE PAGE 7)

**J13**

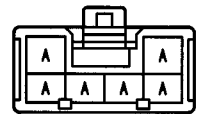

(HINT:SEE PAGE 7)

**L 2**



**L 3**

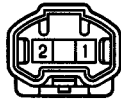

**L 4**

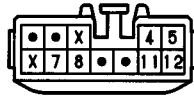

**R 9, R11**

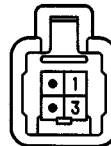

**R10, R12**

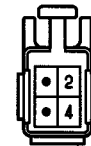

# STOP LIGHT

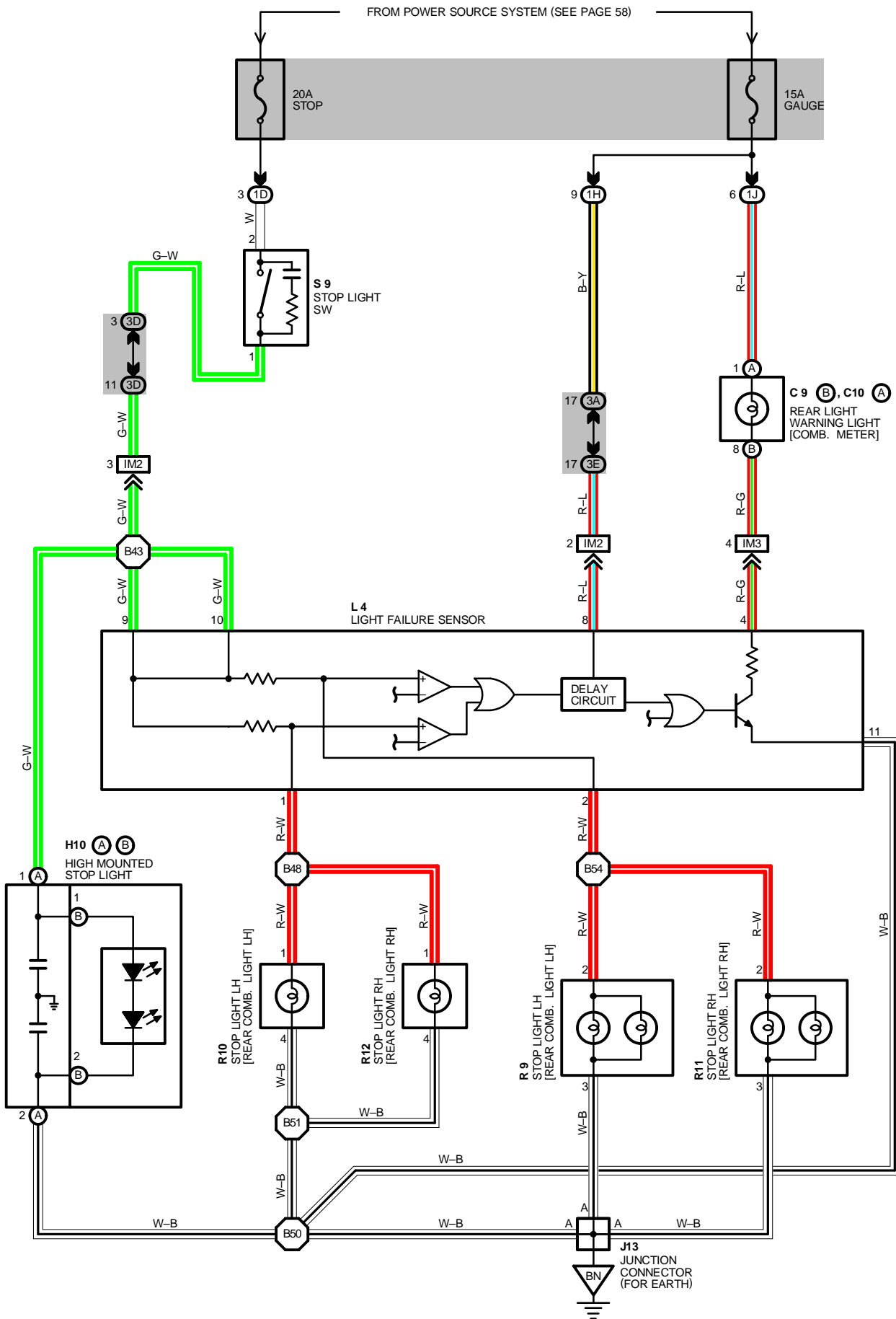



## SYSTEM OUTLINE

CURRENT IS APPLIED AT ALL TIMES THROUGH A **STOP FUSE** TO **TERMINAL 2** OF THE STOP LIGHT SW.

WHEN THE IGNITION SW IS TURNED ON, CURRENT FLOWS FROM THE **GAUGE FUSE** TO **TERMINAL 8** OF THE LIGHT FAILURE SENSOR, AND ALSO FLOWS THROUGH THE REAR LIGHT WARNING LIGHT TO **TERMINAL 4** OF THE LIGHT FAILURE SENSOR.

### STOP LIGHT DISCONNECTION WARNING

WHEN THE IGNITION SW IS TURNED ON AND THE BRAKE PEDAL IS PRESSED (STOP LIGHT SW ON), IF THE STOP LIGHT CIRCUIT IS OPEN, THE CURRENT FLOWING FROM **TERMINAL 9, 10** OF THE LIGHT FAILURE SENSOR TO **TERMINALS 1, 2** CHANGES, SO THE LIGHT FAILURE SENSOR DETECTS THE DISCONNECTION AND THE WARNING CIRCUIT OF THE LIGHT FAILURE SENSOR IS ACTIVATED.

AS A RESULT, THE CURRENT FLOWS FROM **TERMINAL 4** OF THE LIGHT FAILURE SENSOR → **TERMINAL 11** → **GROUND** AND TURNS THE REAR LIGHT WARNING LIGHT ON. BY PRESSING THE BRAKE PEDAL, THE CURRENT FLOWING TO **TERMINAL 8** OF THE LIGHT FAILURE SENSOR KEEPS THE WARNING CIRCUIT ON HOLD AND THE WARNING LIGHT ON UNTIL THE IGNITION SW IS TURNED OFF.

## SERVICE HINTS

### S 9 STOP LIGHT SW

2-1: CLOSED WITH BRAKE PEDAL DEPRESSED

### L 4 LIGHT FAILURE SENSOR

9, 10-GROUND : APPROX. 12 VOLTS WITH STOP LIGHT SW ON

4, 8-GROUND : APPROX. 12 VOLTS WITH IGNITION SW AT **ON** POSITION

11-GROUND : ALWAYS CONTINUITY

## ○ : PARTS LOCATION

CODE		SEE PAGE	CODE	SEE PAGE	CODE	SEE PAGE
C 9	B	28	J13	30	R11	31
C10	A	28	L 4	30	R12	31
H10	A	30	R 9	31	S 9	29
	B	30	R10	31		

## ○ : JUNCTION BLOCK AND WIRE HARNESS CONNECTOR

CODE	SEE PAGE	JUNCTION BLOCK AND WIRE HARNESS (CONNECTOR LOCATION)
1D	20	COWL WIRE AND J/B NO. 1 (LEFT KICK PANEL)
1H		
1J		
3A	22	COWL WIRE AND J/B NO. 3 (BEHIND THE INSTRUMENT PANEL CENTER)
3D		
3E		

## □ : CONNECTOR JOINING WIRE HARNESS AND WIRE HARNESS

CODE	SEE PAGE	JOINING WIRE HARNESS AND WIRE HARNESS (CONNECTOR LOCATION)
IM2	38	COWL WIRE AND FLOOR NO. 1 WIRE (RIGHT KICK PANEL)
IM3		

## ▽ : GROUND POINTS

CODE	SEE PAGE	GROUND POINTS LOCATION
BN	40	LUGGAGE ROOM RIGHT

## ○ : SPLICE POINTS

CODE	SEE PAGE	WIRE HARNESS WITH SPLICE POINTS	CODE	SEE PAGE	WIRE HARNESS WITH SPLICE POINTS
B43	40	FLOOR NO. 1 WIRE	B51	40	FLOOR NO. 1 WIRE
B48			B54		
B50					

# STOP LIGHT

C 9 (B)

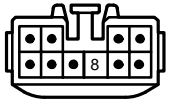

C10 (A) ORANGE

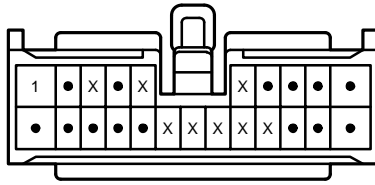

H10 (A) BLUE

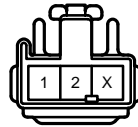

H10 (B)

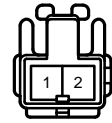

J13

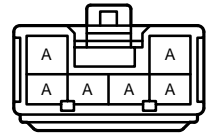

(HINT : SEE PAGE 7)

L 4

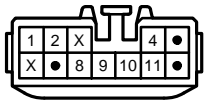

R 9, R11

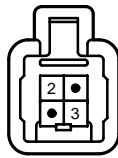

R10, R12

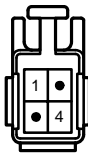

S 9

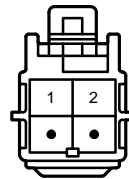

# BACK-UP LIGHT

FROM POWER SOURCE SYSTEM (SEE PAGE 58)

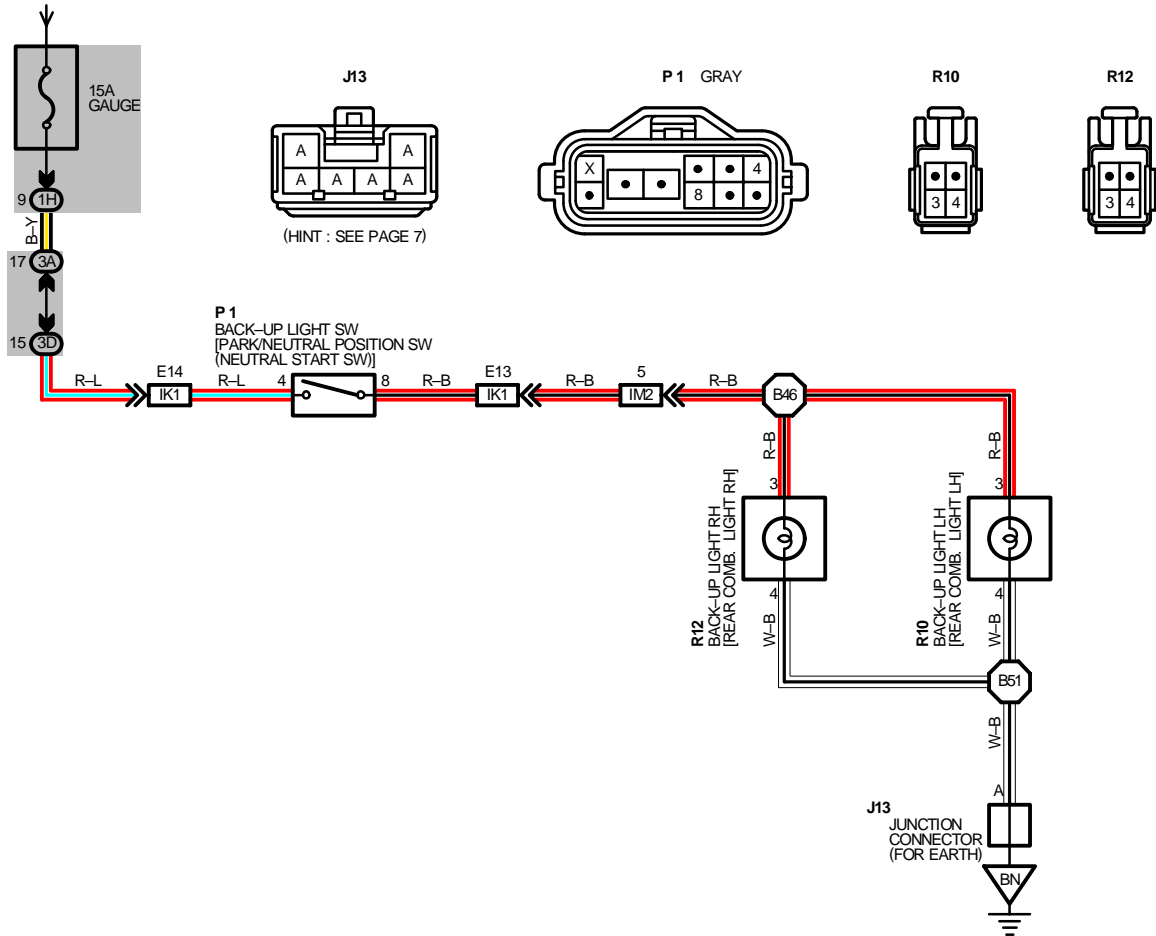

## SERVICE HINTS

**P 1 BACK-UP LIGHT SW [PARK/NEUTRAL POSITION SW (NEUTRAL START SW)]**  
4-8: CLOSED WITH SHIFT LEVER IN R POSITION

### ○ : PARTS LOCATION

CODE	SEE PAGE	CODE	SEE PAGE	CODE	SEE PAGE
J13	30	R10	31		
P 1	27	R12	31		

### ○ : JUNCTION BLOCK AND WIRE HARNESS CONNECTOR

CODE	SEE PAGE	JUNCTION BLOCK AND WIRE HARNESS (CONNECTOR LOCATION)
1H	20	COWL WIRE AND J/B NO. 1 (LEFT KICK PANEL)
3A	22	COWL WIRE AND J/B NO. 3 (BEHIND THE INSTRUMENT PANEL CENTER)
3D		

### □ : CONNECTOR JOINING WIRE HARNESS AND WIRE HARNESS

CODE	SEE PAGE	JOINING WIRE HARNESS AND WIRE HARNESS (CONNECTOR LOCATION)
IK1	38	ENGINE WIRE AND COWL WIRE (UNDER THE GLOVE BOX)
IM2	38	COWL WIRE AND FLOOR NO. 1 WIRE (RIGHT KICK PANEL)

### ▽ : GROUND POINTS

CODE	SEE PAGE	GROUND POINTS LOCATION
BN	40	LUGGAGE ROOM RIGHT

### ○ : SPLICE POINTS

CODE	SEE PAGE	WIRE HARNESS WITH SPLICE POINTS	CODE	SEE PAGE	WIRE HARNESS WITH SPLICE POINTS
B46	40	FLOOR NO. 1 WIRE	B51	40	FLOOR NO. 1 WIRE

# AUTOMATIC LIGHT CONTROL

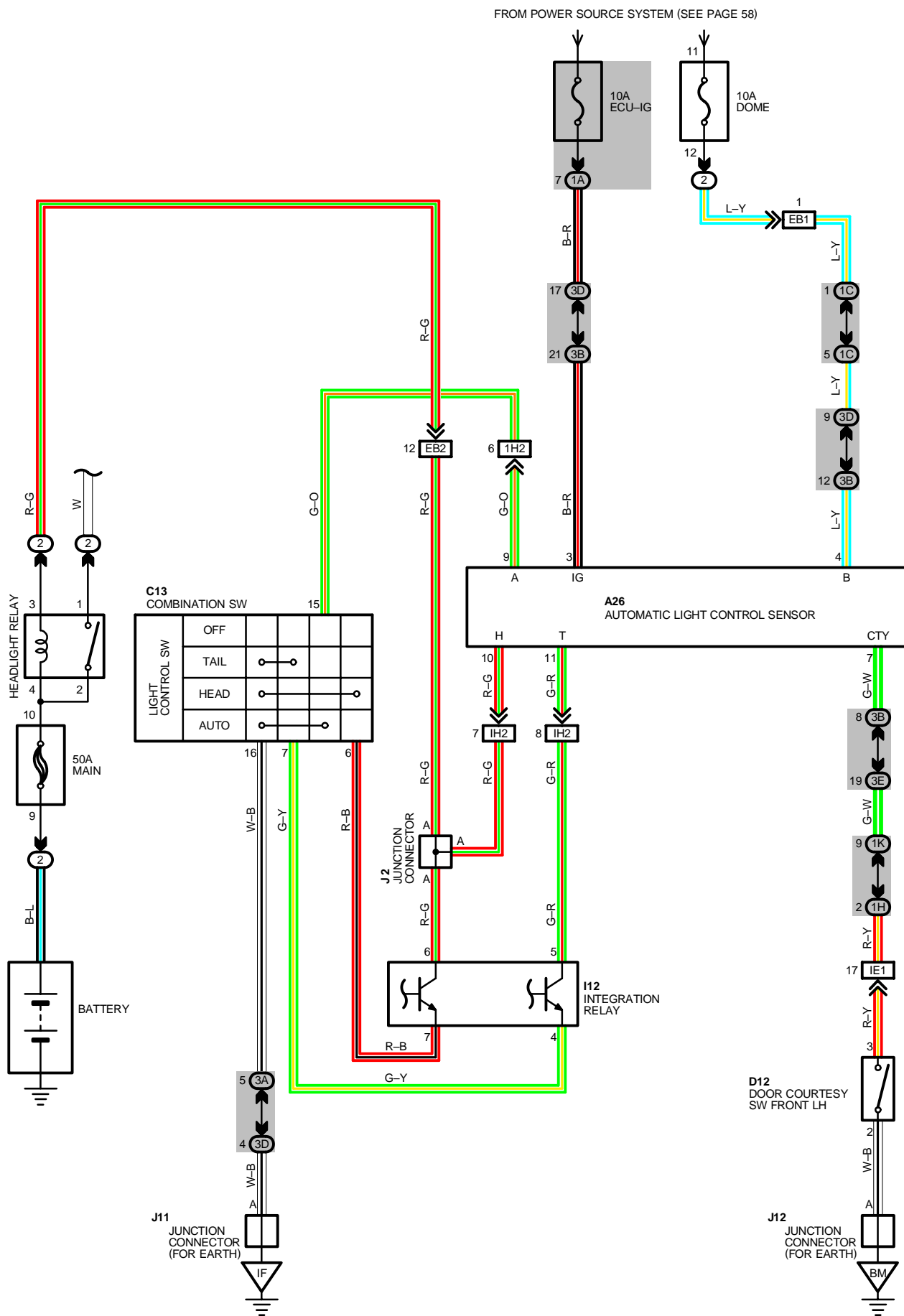

## SYSTEM OUTLINE

WITH THE IGNITION SW TURNED ON, THE CURRENT FLOWS TO **TERMINAL 3** OF AUTOMATIC LIGHT CONTROL SENSOR THROUGH **ECU-IG** FUSE. VOLTAGE IS APPLIED AT ALL TIMES TO **TERMINAL 4** OF AUTOMATIC LIGHT CONTROL SENSOR THROUGH **DOM**E FUSE, AND TO **TERMINAL 10** OF THE AUTOMATIC LIGHT CONTROL SENSOR THROUGH THE HEADLIGHT RELAY COIL.

### AUTOMATIC LIGHT CONTROL

WHEN THE LIGHT CONTROL SW IS IN AUTO POSITION, IF THE AUTOMATIC LIGHT CONTROL SENSOR DETECTS A DECREASE IN THE AMBIENT LIGHT (TO BETWEEN **80** AND **400** LUX), THE AUTOMATIC LIGHT SENSOR IS ACTIVATED. ABOUT **5** SECONDS AFTER IT IS ACTIVATED, CURRENT FLOWS FROM **TERMINAL 9** OF THE SENSOR TO **TERMINAL 15** OF THE LIGHT CONTROL SW TO **TERMINAL 16** TO **GROUND**, LIGHTING UP THE HEADLIGHT AND TAILLIGHTS.

IF THE AMBIENT LIGHT DROP BELOW **80** LUX, THE AUTOMATIC LIGHT SENSOR IS ACTIVATED AND ABOUT **3** SECONDS LATER CURRENT FLOWS FROM **TERMINAL 9** OF THE SENSOR TO **TERMINAL 15** OF THE LIGHT CONTROL SW TO **TERMINAL 16** TO **GROUND**, LIGHTING UP THE HEADLIGHTS AND TAILLIGHTS.

WHEN THE LIGHT CONTROL SW IS AT AUTO POSITION AND ACTIVATION OF THE AUTOMATIC LIGHT SENSOR HAS TURNED ON THE HEADLIGHTS AND TAILLIGHTS, IF THE AUTOMATIC LIGHT CONTROL SENSOR DETECTS AMBIENT LIGHT ABOVE **800** LUX, THE SENSOR IS TURNED OFF AFTER ABOUT **5** SECONDS. SO THE CURRENT FROM **TERMINAL 9** OF THE SENSOR TO **TERMINAL 15** OF LIGHT CONTROL SW STOP, AND THE HEADLIGHTS AND TAILLIGHTS TURN OFF.

## SERVICE HINTS

### A26 AUTOMATIC LIGHT CONTROL SENSOR

- 4-GROUND: ALWAYS APPROX. **12** VOLTS
- 3-GROUND: APPROX. **12** VOLTS WITH THE IGNITION SW AT **ON** POSITION
- 9-GROUND: CONTINUITY WITH LIGHT CONTROL SW AT **AUTO** POSITION
- 7-GROUND: CONTINUITY WITH DRIVER'S DOOR OPEN

### HEADLIGHT RELAY

- (2)1- (2)2 : CLOSED WITH LIGHT CONTROL SW AT **HEAD** POSITION

### C13 LIGHT CONTROL SW [COMB. SW]

- 15-16 : CLOSED WITH LIGHT CONTROL SW AT **AUTO** POSITION

## ○ : PARTS LOCATION

CODE	SEE PAGE	CODE	SEE PAGE	CODE	SEE PAGE
<b>A26</b>	<a href="#">28</a>	<b>I12</b>	<a href="#">29</a>	<b>J12</b>	<a href="#">30</a>
<b>C13</b>	<a href="#">28</a>	<b>J 2</b>	<a href="#">29</a>		
<b>D12</b>	<a href="#">30</a>	<b>J11</b>	<a href="#">29</a>		

## ○ : RELAY BLOCKS

CODE	SEE PAGE	RELAY BLOCKS (RELAY BLOCK LOCATION)
<b>2</b>	<a href="#">19</a>	R/B NO.2 (ENGINE COMPARTMENT LEFT)

## ○ : JUNCTION BLOCK AND WIRE HARNESS CONNECTOR

CODE	SEE PAGE	JUNCTION BLOCK AND WIRE HARNESS (CONNECTOR LOCATION)
<b>1A</b>	<a href="#">20</a>	COWL WIRE AND J/B NO.1 (LEFT KICK PANEL)
<b>1C</b>		
<b>1H</b>		
<b>1K</b>		
<b>3A</b>	<a href="#">22</a>	COWL WIRE AND J/B NO. 3 (BEHIND THE INSTRUMENT PANEL CENTER)
<b>3B</b>	<a href="#">22</a>	INSTRUMENT PANEL WIRE AND J/B NO. 3 (BEHIND THE INSTRUMENT PANEL CENTER)
<b>3D</b>	<a href="#">22</a>	COWL WIRE AND J/B NO. 3 (BEHIND THE INSTRUMENT PANEL CENTER)
<b>3E</b>		

## □ : CONNECTOR JOINING WIRE HARNESS AND WIRE HARNESS

CODE	SEE PAGE	JOINING WIRE HARNESS AND WIRE HARNESS (CONNECTOR LOCATION)
<b>EB1</b>	<a href="#">34</a>	COWL WIRE AND R/B NO. 2 WIRE (INSIDE OF R/B NO. 2)
<b>EB2</b>		
<b>IE1</b>	<a href="#">36</a>	COWL WIRE AND FLOOR NO. 2 WIRE (LEFT KICK PANEL)
<b>IH2</b>	<a href="#">36</a>	COWL WIRE AND INSTRUMENT PANEL WIRE (BEHIND GLOVE BOX)

## ▽ : GROUND POINTS

CODE	SEE PAGE	GROUND POINTS LOCATION
<b>IF</b>	<a href="#">36</a>	BEHIND COMBINATION METER
<b>BM</b>	<a href="#">40</a>	LUGGAGE ROOM LEFT

# AUTOMATIC LIGHT CONTROL

---

A26

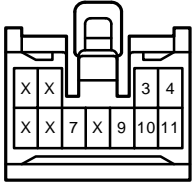

C13

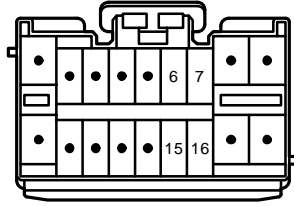

D12 BLACK

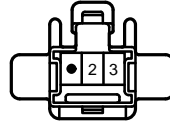

I12

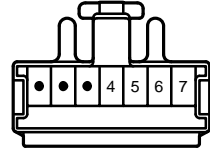

J 2

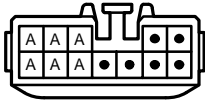

(HINT : SEE PAGE 7)

J11, J12

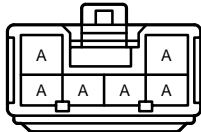

(HINT : SEE PAGE 7)

# HORN

FROM POWER SOURCE SYSTEM (SEE PAGE 58)

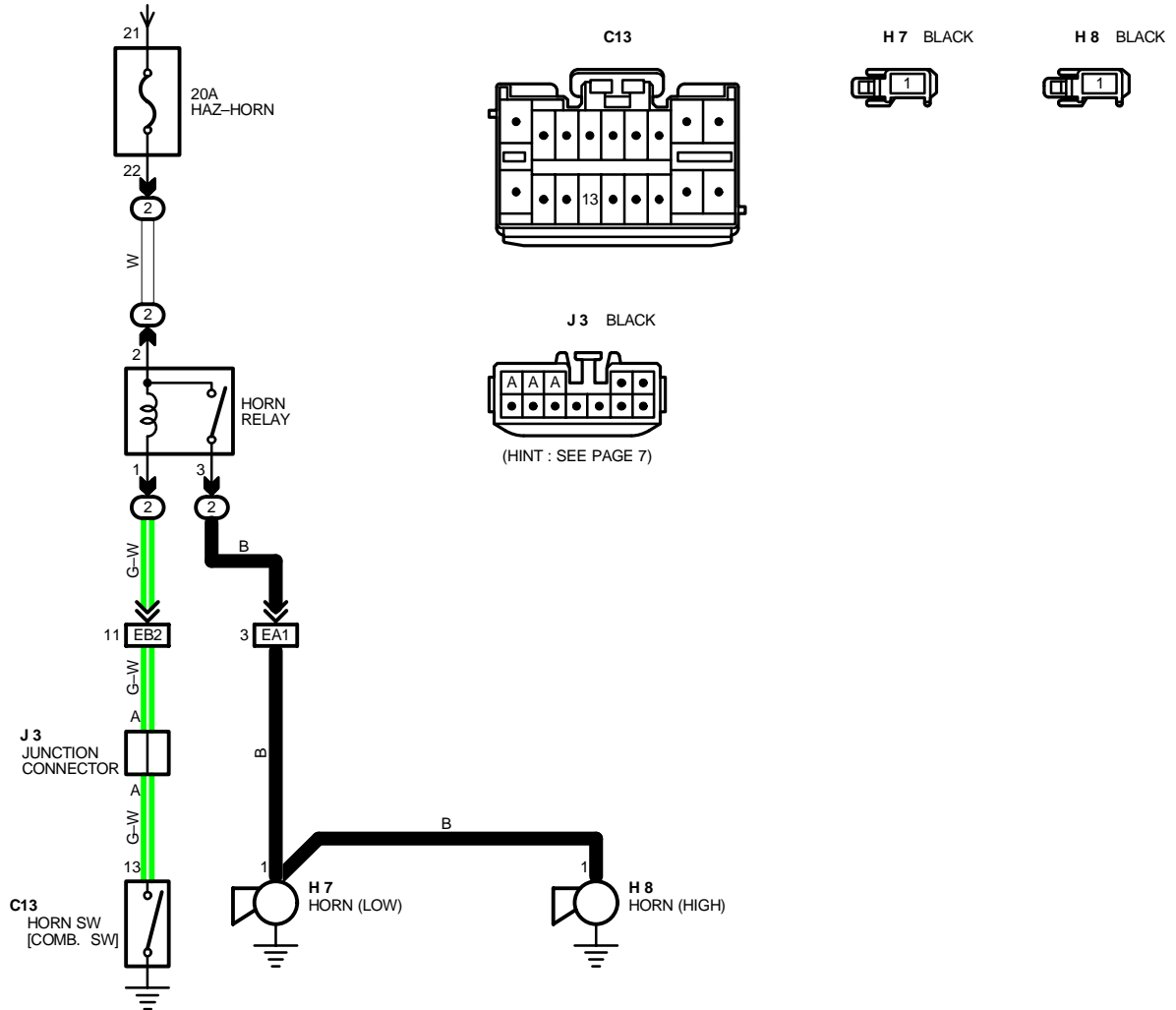

## SERVICE HINTS

### HORN RELAY

(2)2- (2)3 : CLOSED WITH HORN SW ON

### ○ : PARTS LOCATION

CODE	SEE PAGE	CODE	SEE PAGE	CODE	SEE PAGE
C13	28	H 8	26		
H 7	26	J 3	29		

### □ : RELAY BLOCKS

CODE	SEE PAGE	RELAY BLOCKS (RELAY BLOCK LOCATION)
2	19	R/B NO. 2 (ENGINE COMPARTMENT LEFT)

### □ : CONNECTOR JOINING WIRE HARNESS AND WIRE HARNESS

CODE	SEE PAGE	JOINING WIRE HARNESS AND WIRE HARNESS (CONNECTOR LOCATION)
EA1	34	ENGINE ROOM MAIN WIRE AND R/B NO. 2 WIRE (INSIDE OF R/B NO. 2)
EB2	34	COWL WIRE AND R/B NO. 2 WIRE (INSIDE OF R/B NO. 2)

# LIGHT AUTO TURN OFF

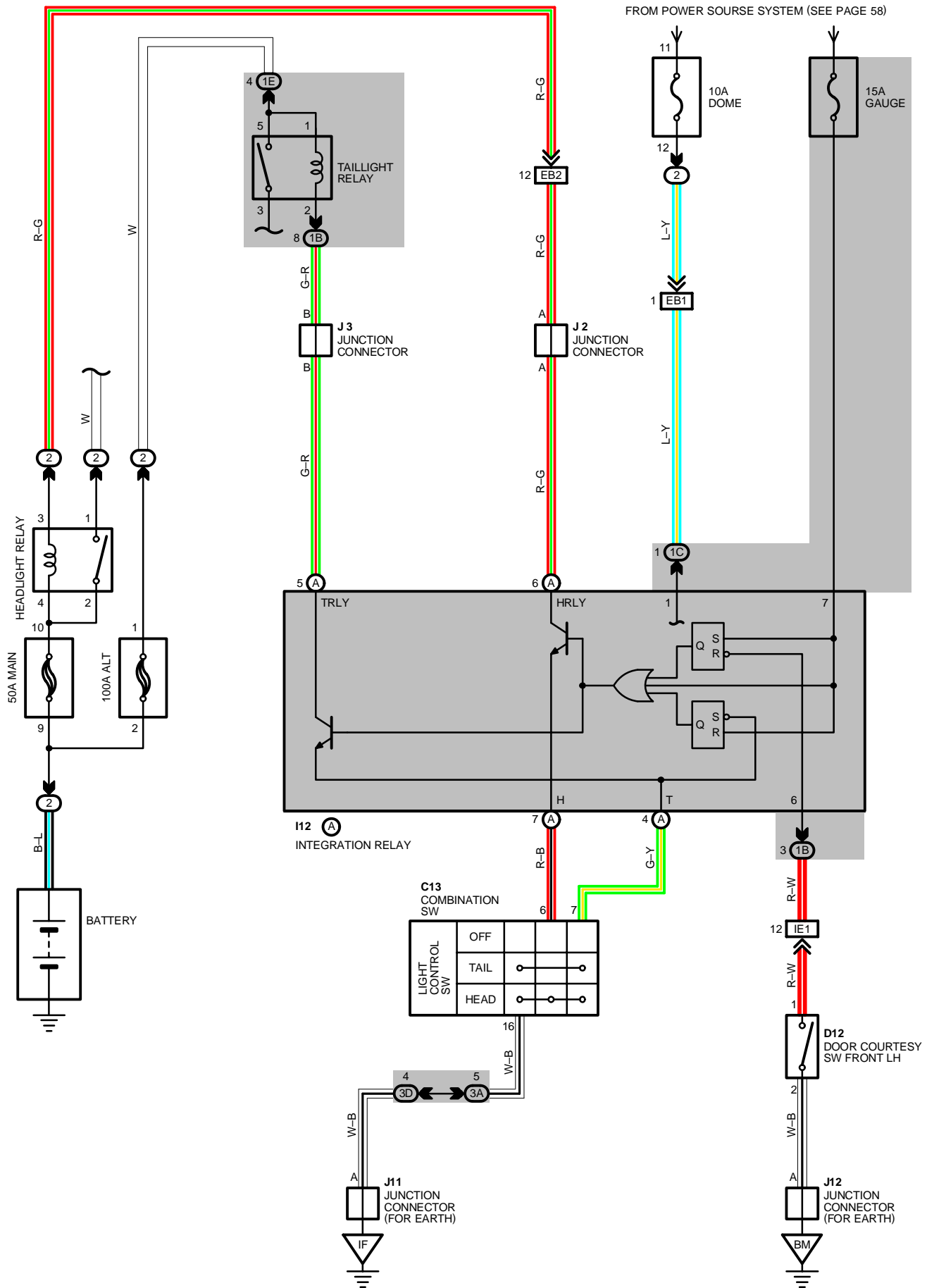



## SYSTEM OUTLINE

WITH THE IGNITION SW TURNED ON, THE CURRENT FLOWS TO **TERMINAL 7** OF THE INTEGRATION RELAY THROUGH **GAUGE FUSE**.

VOLTAGE IS APPLIED AT ALL TIMES TO **TERMINAL (A)5** OF THE INTEGRATION RELAY THROUGH THE TAILLIGHT RELAY COIL, AND TO **TERMINAL (A)6** THROUGH THE HEADLIGHT RELAY COIL.

### 1. NORMAL LIGHTING OPERATION

<TURN TAILLIGHT ON>

WITH LIGHT CONTROL SW TURNED TO **TAIL** POSITION, A SIGNAL IS INPUT INTO **TERMINAL (A)4** OF THE INTEGRATION RELAY. DUE TO THIS SIGNAL, THE CURRENT FLOWING TO **TERMINAL (A)5** OF THE RELAY FLOWS TO **TERMINAL (A)4** → **TERMINAL 7** OF THE LIGHT CONTROL SW → **TERMINAL 16** → TO **GROUND** AND TAILLIGHT RELAY CAUSES TAILLIGHTS TO TURN ON.

<TURN HEADLIGHT ON>

WITH LIGHT CONTROL SW TURNED TO **HEAD** POSITION, A SIGNAL INPUT INTO **TERMINALS (A)4** AND **(A)7** OF THE INTEGRATION RELAY. DUE TO THIS SIGNAL, THE CURRENT FLOWING TO **TERMINAL (A)6** OF THE RELAY FLOWS TO **TERMINAL (A)7** → **TERMINAL 6** OF THE LIGHT CONTROL SW → **TERMINAL 16** → TO **GROUND** IN THE HEADLIGHT CIRCUIT, AND CAUSES TAILLIGHT AND HEADLIGHT RELAY TO TURN ON. THE TAILLIGHT CIRCUIT IS SAME AS ABOVE.

### 2. LIGHT AUTO TURN OFF OPERATION

WITH LIGHT ON AND IGNITION SW TURNED OFF (INPUT SIGNAL GOES TO **TERMINAL 7** OF THE RELAY), WHEN DOOR ON DRIVER'S SIDE IS OPENED (INPUT SIGNAL GOES TO **TERMINAL 6** OF THE RELAY), THE RELAY OPERATES AND THE CURRENT IS CUT OFF WHICH FLOWS FROM **TERMINAL (A)5** OF THE RELAY TO **TERMINAL (A)4** IN TAILLIGHT CIRCUIT AND FROM **TERMINAL (A)6** TO **TERMINAL (A)7** IN HEADLIGHT CIRCUIT.

AS A RESULT, ALL LIGHTS ARE TURNED OFF AUTOMATICALLY.

## SERVICE HINTS

### HEAD RELAY

(2)2- (2)1 : CLOSED WITH LIGHT CONTROL SW AT **HEAD** POSITION OR DIMMER SW AT **FLASH** POSITION (FOR USA)  
: CLOSED WITH ENGINE RUNNING AND PARKING BRAKE PEDAL RELEASED (FOR CANADA)

### TAILLIGHT RELAY

5-3: CLOSED WITH LIGHT CONTROL SW AT **TAIL** OR **HEAD** POSITION

### D12 DOOR COURTESY SW FRONT LH

1-2: CLOSED WITH FRONT LH DOOR OPEN

### I12 INTEGRATION RELAY

7-GROUND : APPROX. **12** VOLTS WITH IGNITION SW AT **ON** POSITION

6-GROUND : CONTINUITY WITH FRONT LH DOOR OPEN

1-GROUND : ALWAYS APPROX. **12** VOLTS

(A) 5-GROUND : ALWAYS APPROX. **12** VOLTS

(A) 6-GROUND : ALWAYS APPROX. **12** VOLTS

(A) 7-GROUND : CONTINUITY WITH LIGHT CONTROL SW AT **HEAD** POSITION

(A) 4-GROUND : CONTINUITY WITH LIGHT CONTROL SW AT **TAIL** OR **HEAD** POSITION

## ○ : PARTS LOCATION

CODE	SEE PAGE	CODE	SEE PAGE	CODE	SEE PAGE
C13	28	J 2	29	J12	30
D12	30	J 3	29		
I12	A 29	J11	29		

## ○ : RELAY BLOCKS

CODE	SEE PAGE	RELAY BLOCKS (RELAY BLOCK LOCATION)
2	19	R/B NO. 2 (ENGINE COMPARTMENT LEFT)

## ○ : JUNCTION BLOCK AND WIRE HARNESS CONNECTOR

CODE	SEE PAGE	JUNCTION BLOCK AND WIRE HARNESS (CONNECTOR LOCATION)
1B	20	COWL WIRE AND J/B NO.1 (LEFT KICK PANEL)
1C		
1E		
3A	22	COWL WIRE AND J/B NO. 3 (BEHIND THE INSTRUMENT PANEL CENTER)
3D		

# LIGHT AUTO TURN OFF

 : CONNECTOR JOINING WIRE HARNESS AND WIRE HARNESS

CODE	SEE PAGE	JOINING WIRE HARNESS AND WIRE HARNESS (CONNECTOR LOCATION)
EB1	34	COWL WIRE AND R/B NO. 2 WIRE (INSIDE OF R/B NO. 2)
EB2		
IE1	36	COWL WIRE AND FLOOR NO. 2 WIRE (LEFT KICK PANEL)

 : GROUND POINTS

CODE	SEE PAGE	GROUND POINTS LOCATION
IF	36	BEHIND COMBINATION METER
BM	40	LUGGAGE ROOM LEFT

C13

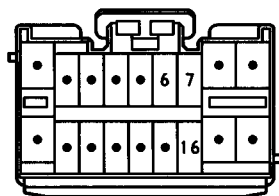

D12 BLACK

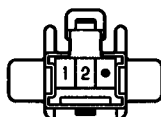

I12 (A)

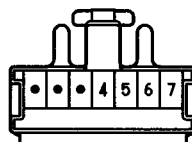

J 2

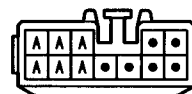

(HINT:SEE PAGE 7)

J 3 BLACK

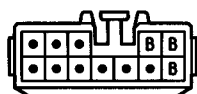

(HINT:SEE PAGE 7)

J11

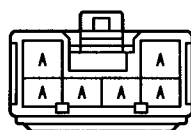

(HINT:SEE PAGE 7)

J12

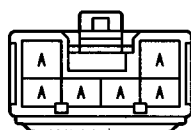

(HINT:SEE PAGE 7)

# HEADLIGHT CLEANER (FOR CANADA)

## SERVICE HINTS

### H 2 HEADLIGHT CLEANER RELAY

5-2 : CLOSED WITH IGNITION SW AT **ON** POSITION AND HEADLIGHT CLEANER SW **ON** POSITION

### ○ : PARTS LOCATION

CODE	SEE PAGE	CODE	SEE PAGE	CODE	SEE PAGE
C13	28	D 5	28	I12	29
C14	28	H 1	26	J 2	29
D 4	28	H 2	26	J11	29

### ○ : RELAY BLOCKS

CODE	SEE PAGE	RELAY BLOCKS (RELAY BLOCK LOCATION)
2	19	R/B NO. 2 (ENGINE COMPARTMENT LEFT)

### ○ : JUNCTION BLOCK AND WIRE HARNESS CONNECTOR

CODE	SEE PAGE	JUNCTION BLOCK AND WIRE HARNESS (CONNECTOR LOCATION)
1H	20	COWL WIRE AND J/B NO. 1 (LEFT KICK PANEL)
1L		
3A	22	COWL WIRE AND J/B NO. 3 (BEHIND THE INSTRUMENT PANEL CENTER)
3D		

### □ : CONNECTOR JOINING WIRE HARNESS AND WIRE HARNESS

CODE	SEE PAGE	JOINING WIRE HARNESS AND WIRE HARNESS (CONNECTOR LOCATION)
EB2	34	COWL WIRE AND R/B NO. 2 WIRE (INSIDE OF R/B NO. 2)

### ▽ : GROUND POINTS

CODE	SEE PAGE	GROUND POINTS LOCATION
IE	36	LEFT KICK PANEL
IF	36	BEHIND COMBINATION METER

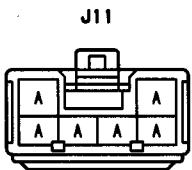
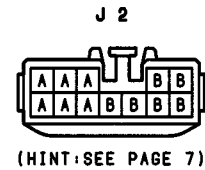
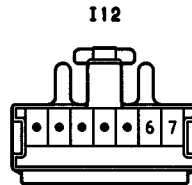
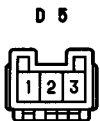
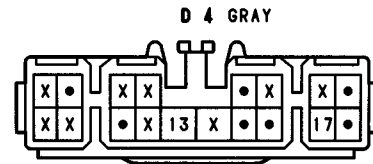
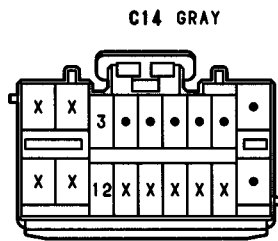
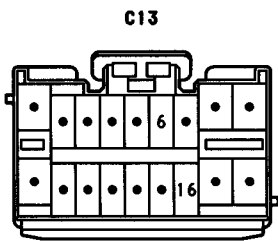

# HEADLIGHT CLEANER (FOR CANADA)

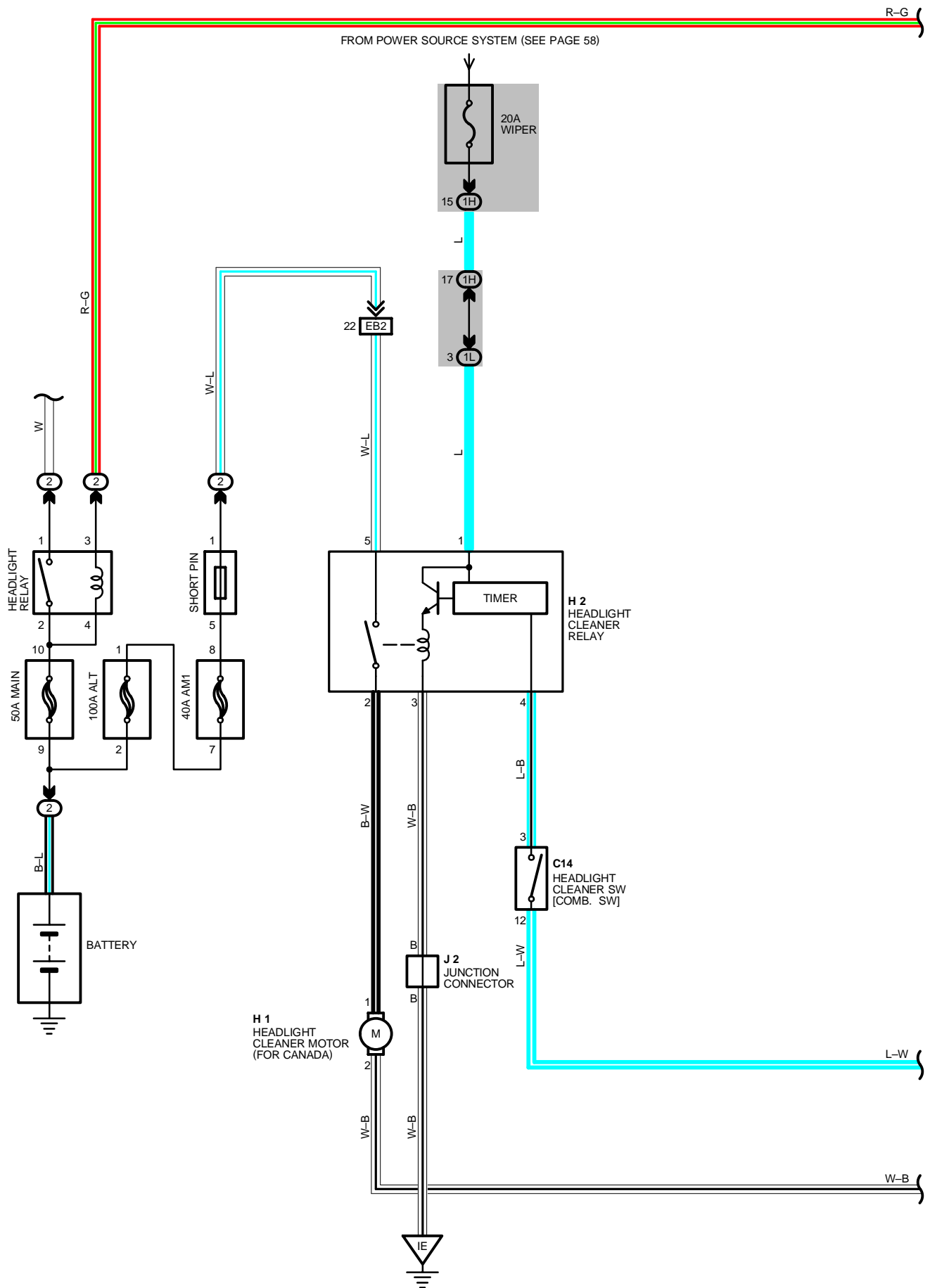

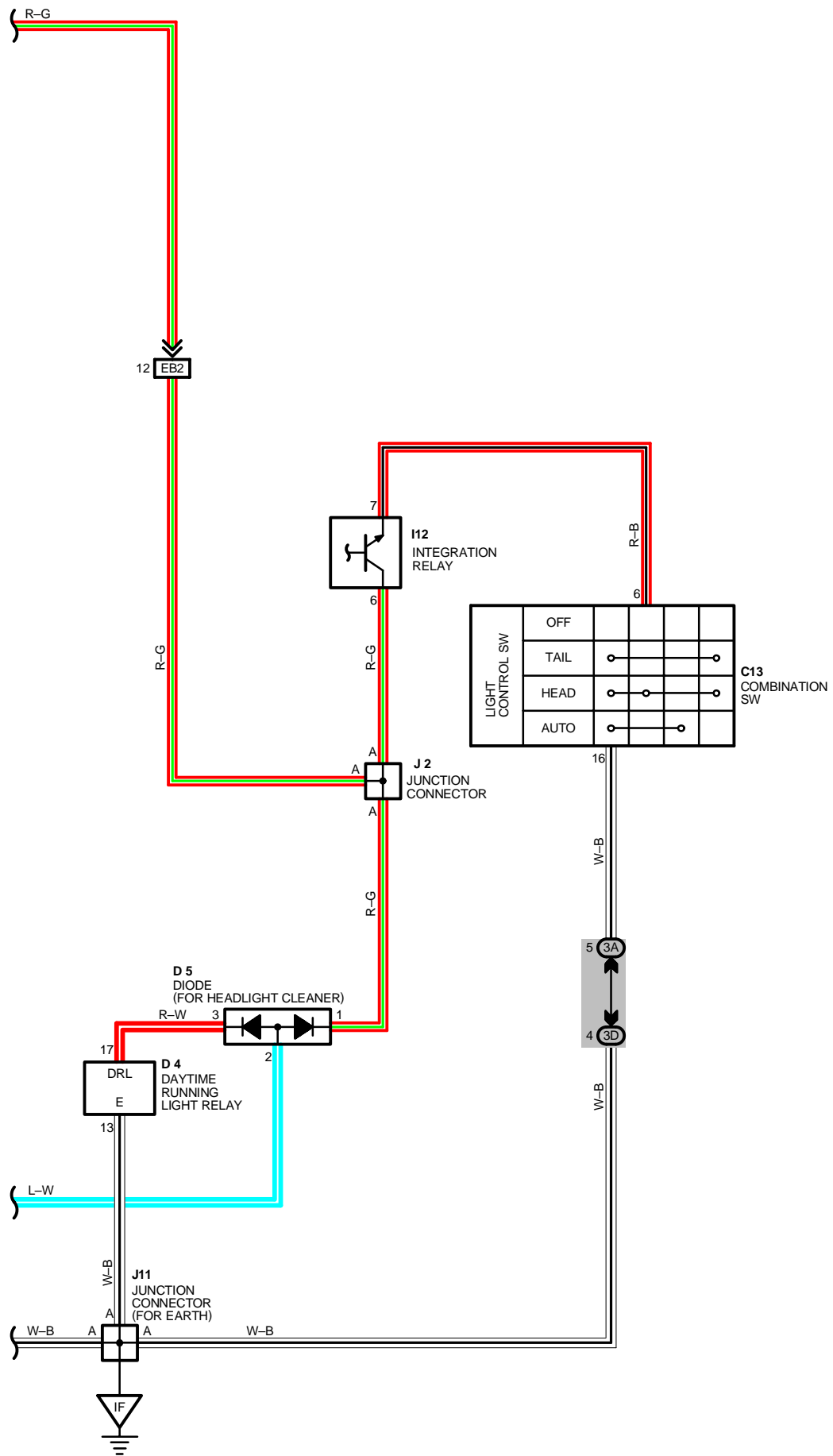

# REMOTE CONTROL MIRROR

FROM POWER SOURCE SYSTEM (SEE PAGE 58)

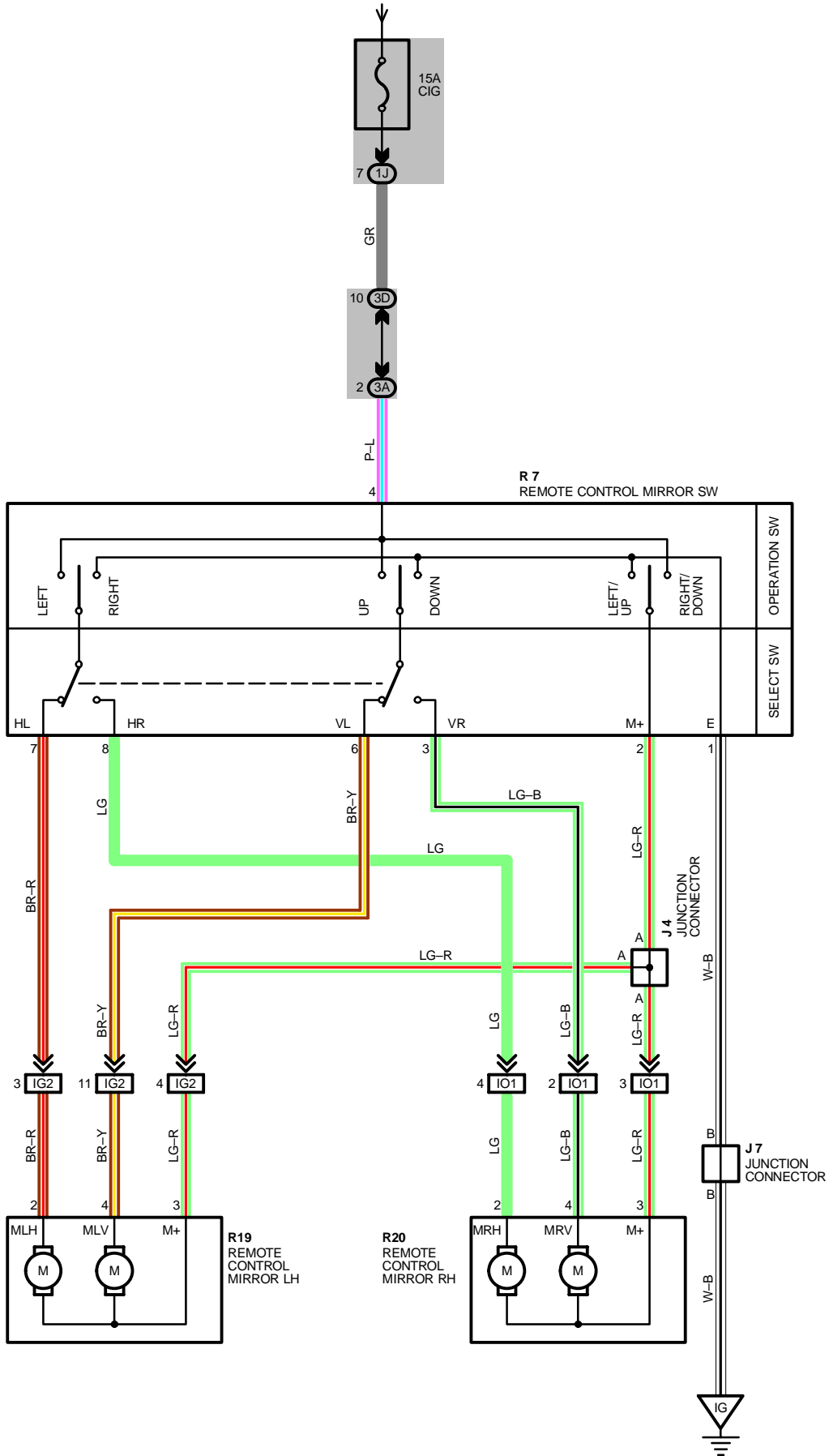

## SERVICE HINTS

### R 7 REMOTE CONTROL MIRROR SW

- 4-GROUND : APPROX. 12 VOLTS WITH IGNITION SW AT **ACC** OR **ON** POSITION
- 2-1 : CONTINUITY WITH OPERATION SW AT **LEFT** OR **UP** POSITION
- 4-2 : CONTINUITY WITH OPERATION SW AT **RIGHT** OR **DOWN** POSITION
- 1-GROUND : ALWAYS CONTINUITY

### ○ : PARTS LOCATION

CODE	SEE PAGE	CODE	SEE PAGE	CODE	SEE PAGE
J 4	29	R 7	29	R20	31
J 7	29	R19	31		

### ○ : JUNCTION BLOCK AND WIRE HARNESS CONNECTOR

CODE	SEE PAGE	JUNCTION BLOCK AND WIRE HARNESS (CONNECTOR LOCATION)
1J	20	COWL WIRE AND J/B NO. 1 (LEFT KICK PANEL)
3A	22	COWL WIRE AND J/B NO. 3 (BEHIND THE INSTRUMENT PANEL CENTER)
3D		

### □ : CONNECTOR JOINING WIRE HARNESS AND WIRE HARNESS

CODE	SEE PAGE	JOINING WIRE HARNESS AND WIRE HARNESS (CONNECTOR LOCATION)
IG2	36	FRONT DOOR LH WIRE AND COWL WIRE (LEFT KICK PANEL)
IO2	38	FRONT DOOR RH WIRE AND COWL WIRE (RIGHT KICK PANEL)

### ▽ : GROUND POINTS

CODE	SEE PAGE	GROUND POINTS LOCATION
IG	36	BEHIND GLOVE BOX

J 4 BLACK

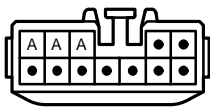

(HINT : SEE PAGE 7)

J 7 GRAY

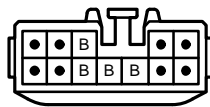

(HINT : SEE PAGE 7)

R 7 GREEN



R19

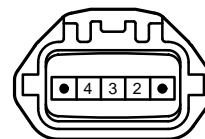

R20



# POWER WINDOW

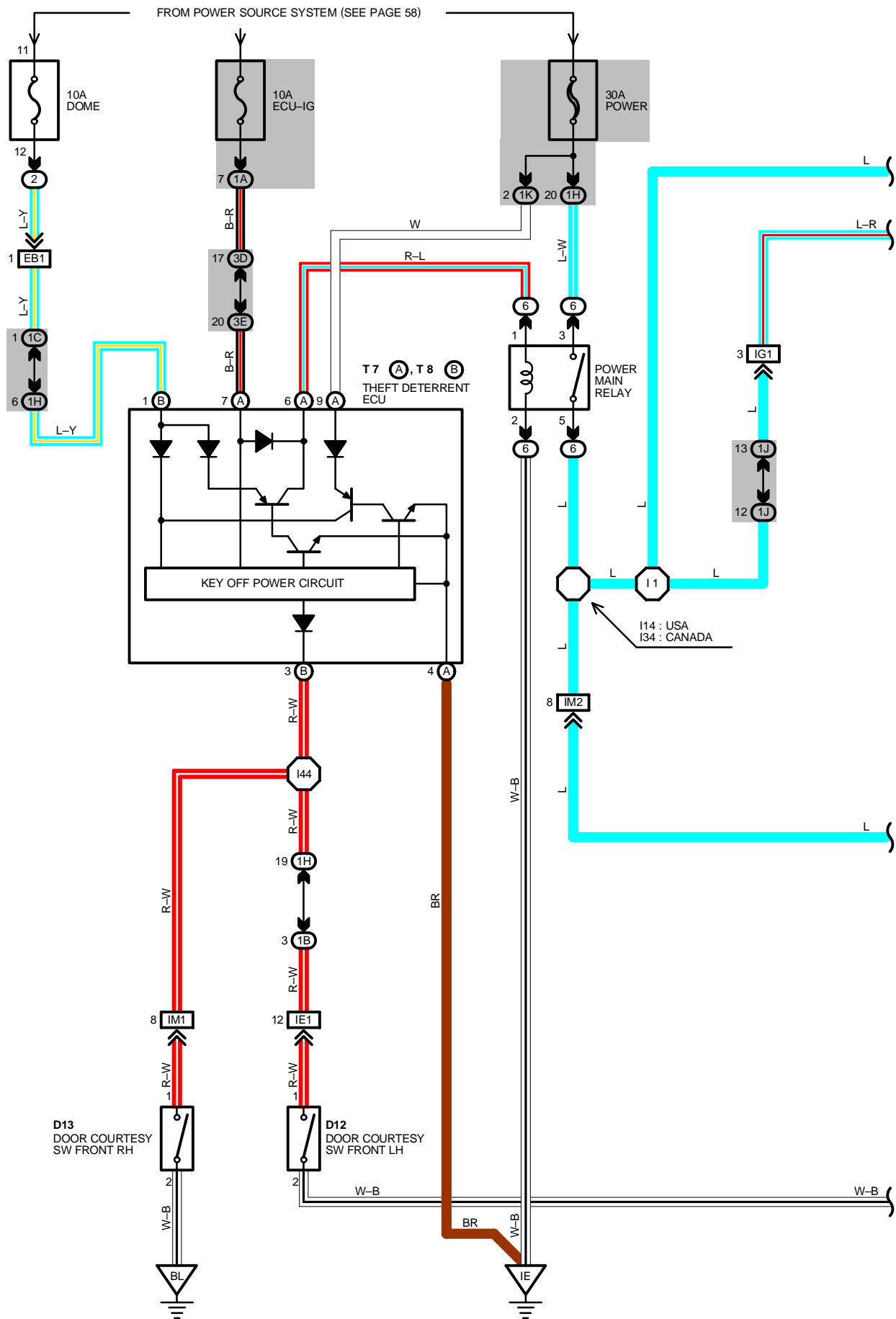



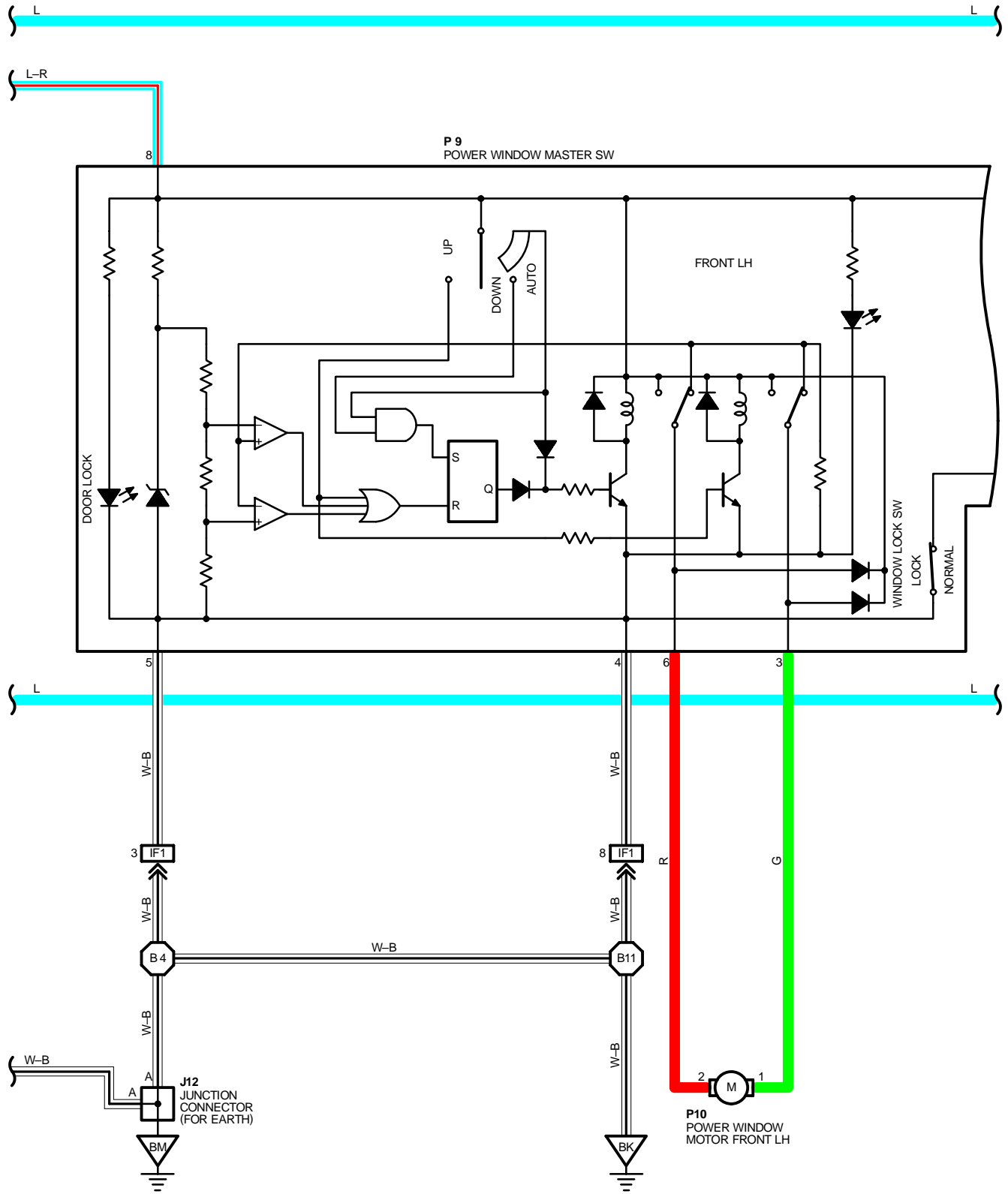

# POWER WINDOW

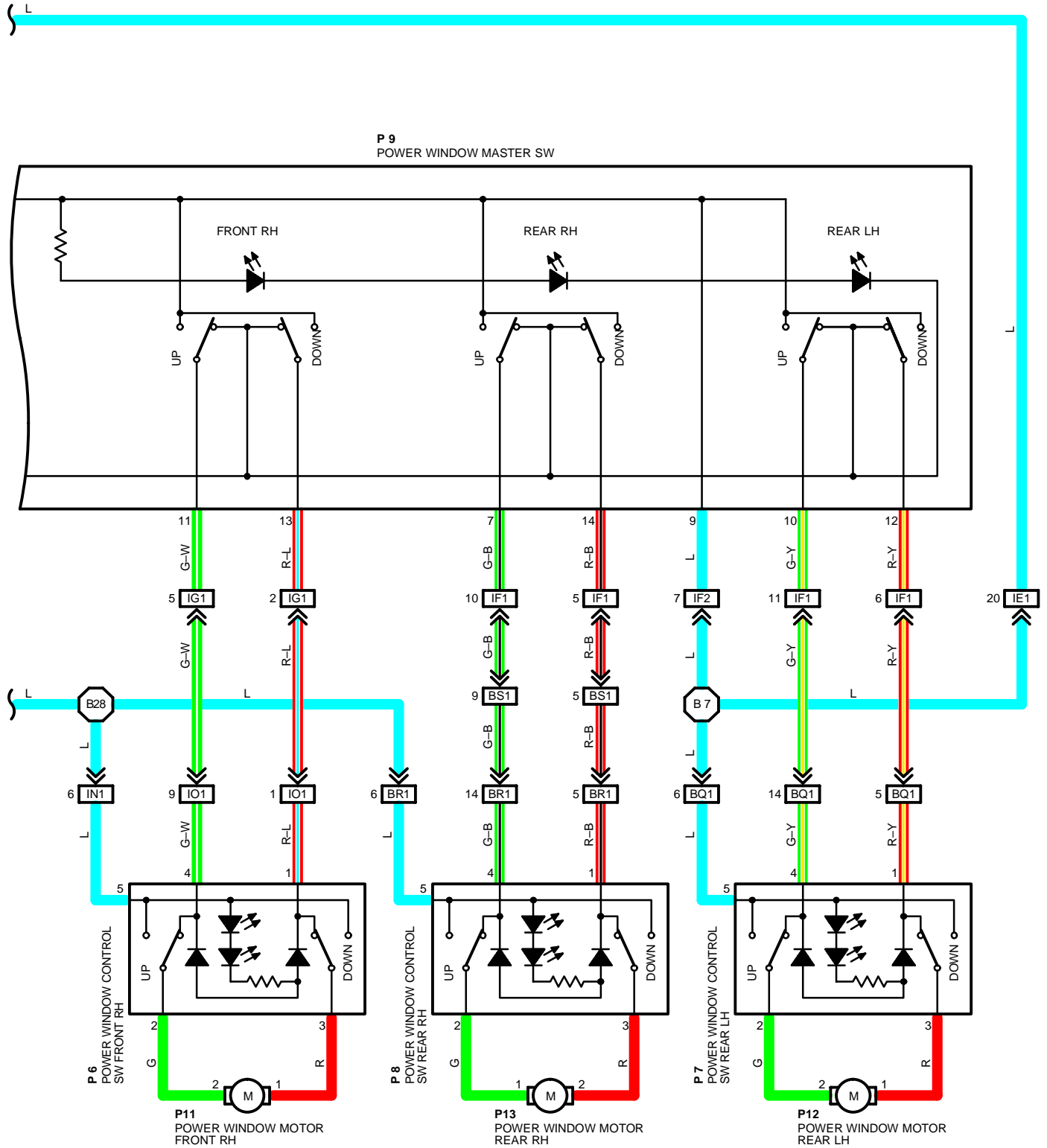

## SYSTEM OUTLINE

WITH THE IGNITION SW TURNED ON, CURRENT FLOWS THROUGH THE ECU-IG FUSE → **TERMINAL (A)7** OF THE THEFT DETERRENT ECU → **TERMINAL (A)6** → **TERMINAL 1** OF THE POWER MAIN RELAY → **TERMINAL 2** → TO **GROUND**, THIS ACTIVATES THE RELAY AND THE CURRENT FLOWING TO **TERMINAL 3** OF THE RELAY FROM **POWER FUSE** FLOWS TO **TERMINAL 5** OF THE RELAY → **TERMINAL 8** OF THE POWER WINDOW MASTER SW, **TERMINAL 5** (FRONT RH, REAR LH, RH) OF THE POWER WINDOW CONTROL SW.

### 1. MANUAL OPERATION (DRIVER'S WINDOW)

WITH THE IGNITION SW TURNED ON AND WITH THE POWER WINDOW MASTER SW (DRIVER'S) IN UP POSITION, THE CURRENT FLOWING TO **TERMINAL 8** OF THE POWER WINDOW MASTER SW FLOWS TO **TERMINAL 3** OF THE MASTER SW → **TERMINAL 1** OF THE POWER WINDOW MOTOR → **TERMINAL 2** → **TERMINAL 6** OF THE MASTER SW → **TERMINAL 4** → TO **GROUND** AND CAUSES THE POWER WINDOW MOTOR TO ROTATE IN THE UP DIRECTION. THE WINDOW ASCENDS ONLY WHILE THE SW IS BEING PUSHED.

IN DOWN OPERATION, THE FLOW OF CURRENT FROM **TERMINAL 8** OF THE POWER WINDOW MASTER SW TO **TERMINAL 6** OF THE MASTER SW CAUSES THE FLOW OF CURRENT FROM **TERMINAL 2** OF THE POWER WINDOW MOTOR → **TERMINAL 1** → **TERMINAL 3** OF THE MASTER SW → **TERMINAL 4** → TO **GROUND**, FLOWING IN THE OPPOSITE DIRECTION TO MANUAL UP OPERATION AND CAUSING THE MOTOR TO ROTATE IN REVERSE, LOWERING THE WINDOW.

### 2. DRIVER'S WINDOW AUTO DOWN OPERATION

WHEN THE DRIVER'S WINDOW SW IS PUSHED STRONGLY ON THE DOWN SIDE, THE CURRENT FLOWING TO **TERMINAL 8** OF THE POWER WINDOW MASTER SW FLOWS TO THE DOWN CONTACT POINT AND AUTO DOWN CONTACT POINT OF THE DRIVER'S SW.

THIS ACTIVATES THE RELAY (DOWN SIDE) INSIDE THE POWER WINDOW MASTER SW AND THE HOLD CIRCUIT ALSO TURNS ON AT THE SAME TIME, SO THE RELAY (DOWN SIDE) REMAINS ACTIVATED EVEN WHEN THE SW IS RELEASED.

CURRENT FLOWS AT THIS TIME FROM **TERMINAL 8** OF THE POWER WINDOW MASTER SW → **TERMINAL 6** → **TERMINAL 2** OF POWER WINDOW MOTOR → **TERMINAL 1** → **TERMINAL 3** OF POWER WINDOW MASTER SW → **TERMINAL 4** → **GROUND**, SO THE MOTOR CONTINUES TO OPERATE UNTIL THE DRIVER'S WINDOW IS FULLY DOWN.

WHEN THE DRIVER'S WINDOW FINISHES DOWN OPERATION THE HOLD CIRCUIT GOES OFF, SO THE RELAY (DOWN SIDE) ALSO TURNS OFF. THIS STOPS THE CURRENT FLOW FROM **TERMINAL 8** OF THE POWER WINDOW MASTER SW TO **TERMINAL 6**, SO THE POWER WINDOW MOTOR STOPS AND AUTO DOWN OPERATION STOPS.

WHEN THE DRIVER'S SW IS PULLED ON THE UP SIDE DURING AUTO DOWN OPERATION, THE HOLD CIRCUIT IS TURNED OFF SO CURRENT FLOW FROM **TERMINAL 8** OF THE POWER WINDOW MASTER SW TO **TERMINAL 6** IS CUT OFF AND THE POWER WINDOW MOTOR STOPS. IF THE SW REMAINS PULLED UP THE RELAY (UP SIDE) IS ACTIVATED, SO CURRENT FLOWS FROM **TERMINAL 8** OF THE POWER WINDOW MASTER SW → **TERMINAL 3** → **TERMINAL 1** OF POWER WINDOW MOTOR → **TERMINAL 2** → **TERMINAL 6** → **TERMINAL 4** → **GROUND**, THE POWER WINDOW MOTOR ROTATES IN THE UP DIRECTION AND MANUAL UP OPERATION OCCURS WHILE THE SW IS PULLED UP.

### 3. MANUAL OPERATION BY POWER WINDOW SW (PASSENGER'S WINDOW)

WITH POWER WINDOW SW (PASSENGER'S) PULLED TO THE UP SIDE, CURRENT FLOWING FROM **TERMINAL 5** OF THE POWER WINDOW CONTROL SW FLOWS TO **TERMINAL 2** OF THE POWER WINDOW SW → **TERMINAL 2** OF THE POWER WINDOW MOTOR → **TERMINAL 1** → **TERMINAL 3** OF THE POWER WINDOW SW → **TERMINAL 1** → **TERMINAL 13** OF THE MASTER SW → **TERMINAL 4** → TO **GROUND** AND CAUSES THE POWER WINDOW MOTOR (PASSENGER'S) TO ROTATE IN THE UP DIRECTION. UP OPERATION CONTINUES ONLY WHILE THE POWER WINDOW SW IS PULLED TO THE UP SIDE. WHEN THE WINDOW DESCENDS, THE CURRENT FLOWING TO THE MOTOR FLOWS IN THE OPPOSITE DIRECTION, FROM **TERMINAL 1** TO **TERMINAL 2**, AND THE MOTOR ROTATES IN REVERSE. WHEN THE WINDOW LOCK SW IS PUSHED TO THE LOCK SIDE, THE GROUND CIRCUIT TO THE PASSENGER'S WINDOW BECOMES OPEN.

AS A RESULT, EVEN IF OPEN/CLOSE OPERATION OF THE PASSENGER'S WINDOW IS TRIED, THE CURRENT FROM **TERMINAL 4** OF THE POWER WINDOW MASTER SW IS NOT GROUNDED AND THE MOTOR DOES NOT ROTATE, SO THE PASSENGER'S WINDOW CANNOT BE OPERATED AND WINDOW LOCK OCCURS. FURTHERMORE, REAR LH, RH WINDOW OPERATE THE SAME AS THE ABOVE CIRCUIT.

### 4. KEY OFF POWER WINDOW OPERATION

WITH THE IGNITION SW TURNED FROM ON TO OFF, THE THEFT DETERRENT ECU OPERATES AND CURRENT FLOWS FROM **POWER FUSE** TO **TERMINAL (A)9** OF THE ECU OR **DOME FUSE** TO **TERMINAL (B)1** OF THE ECU → **TERMINAL (A)6** → **TERMINAL 1** OF POWER MAIN RELAY → **TERMINAL 2** → TO **GROUND** FOR ABOUT 60 SECONDS. THE SAME AS NORMAL OPERATION, THE CURRENT FLOWS FROM **POWER FUSE** → **TERMINAL 3** OF THE POWER MAIN RELAY → **TERMINAL 5** → **TERMINAL 8** OF THE POWER WINDOW MASTER SW AND **TERMINAL 5** (FRONT RH, REAR LH, RH) OF THE POWER WINDOW CONTROL SW. AS A RESULT, FOR ABOUT 60 SECONDS AFTER THE IGNITION SW IS TURNED OFF, THE FUNCTIONING OF THIS RELAY MAKES IT POSSIBLE TO RAISE AND LOWER THE POWER WINDOW. ALSO, BY OPENING THE FRONT DOOR (DOOR OPEN DETECTION SW ON) WITHIN ABOUT 60 SECONDS AFTER TURNING THE IGNITION SW TO OFF, A SIGNAL IS INPUT TO **TERMINAL (B)3** OF THEFT DETERRENT ECU. AS A RESULT, THE ECU TURNED OFF AND UP AND DOWN MOVEMENT OF THE POWER WINDOW STOPS.

# POWER WINDOW

## SERVICE HINTS

### P 9 POWER WINDOW MASTER SW

- 8-GROUND: APPROX. 12 VOLTS WITH IGNITION SW AT **ON** POSITION
- 4, 5-GROUND: ALWAYS CONTINUITY
- 3-GROUND: APPROX. 12 VOLTS WITH IGNITION SW **ON** AND MASTER SW (DRIVER'S WINDOW) AT **UP** POSITION
- 6-GROUND: APPROX. 12 VOLTS WITH IGNITION SW **ON** AND MASTER SW (DRIVER'S WINDOW) AT **DOWN OR AUTO DOWN** POSITION

### WINDOW LOCK SW

- OPEN WITH WINDOW LOCK SW AT **LOCK** POSITION

## ○ : PARTS LOCATION

CODE	SEE PAGE	CODE	SEE PAGE	CODE	SEE PAGE
D12	30	P 8	31	P13	31
D13	30	P 9	31	T 7	A 29
J12	30	P10	31	T 8	B 29
P 6	31	P11	31		
P 7	31	P12	31		

## ○ : RELAY BLOCKS

CODE	SEE PAGE	RELAY BLOCKS (RELAY BLOCK LOCATION)
2	19	R/B NO. 2 (ENGINE COMPARTMENT LEFT)
6	24	R/B NO. 6 (LEFT KICK PANEL)

## ○ : JUNCTION BLOCK AND WIRE HARNESS CONNECTOR

CODE	SEE PAGE	JUNCTION BLOCK AND WIRE HARNESS (CONNECTOR LOCATION)
1A	20	COWL WIRE AND J/B NO.1 (LEFT KICK PANEL)
1B		
1C		
1H		
1J		
1K		
3D	22	COWL WIRE AND J/B NO. 3 (BEHIND THE INSTRUMENT PANEL CENTER)
3E		

## □ : CONNECTOR JOINING WIRE HARNESS AND WIRE HARNESS

CODE	SEE PAGE	JOINING WIRE HARNESS AND WIRE HARNESS (CONNECTOR LOCATION)
EB1	34	FRONT DOOR LH WIRE AND COWL WIRE (LEFT KICK PANEL)
IE1	36	FRONT DOOR RH WIRE AND COWL WIRE (RIGHT KICK PANEL)
IF1	36	FRONT DOOR LH WIRE AND COWL WIRE (LEFT KICK PANEL)
IF2		FRONT DOOR RH WIRE AND COWL WIRE (RIGHT KICK PANEL)
IG1	36	FRONT DOOR LH WIRE AND COWL WIRE (LEFT KICK PANEL)
IM1	38	FRONT DOOR LH WIRE AND COWL WIRE (LEFT KICK PANEL)
IM2		FRONT DOOR RH WIRE AND COWL WIRE (RIGHT KICK PANEL)
IN1	38	FRONT DOOR LH WIRE AND COWL WIRE (LEFT KICK PANEL)
IO1	38	FRONT DOOR RH WIRE AND COWL WIRE (RIGHT KICK PANEL)
BQ1	40	FRONT DOOR RH WIRE AND COWL WIRE (RIGHT KICK PANEL)
BR1	40	FRONT DOOR LH WIRE AND COWL WIRE (LEFT KICK PANEL)
BS1	40	FRONT DOOR RH WIRE AND COWL WIRE (RIGHT KICK PANEL)

## ▽ : GROUND POINTS

CODE	SEE PAGE	GROUND POINTS LOCATION
IE	36	LEFT KICK PANEL
BK	40	UNDER THE FRONT SEAT LH
BL	40	UNDER THE FRONT SEAT RH
BM	40	LUGGAGE ROOM LEFT

## ○ : SPLICE POINTS

CODE	SEE PAGE	WIRE HARNESS WITH SPLICE POINTS	CODE	SEE PAGE	WIRE HARNESS WITH SPLICE POINTS
I 1	38	COWL WIRE	B 4	40	FLOOR NO. 2 WIRE
I14			B 7		
I34			B11		
I44			B28	40	FLOOR NO. 1 WIRE

D12 BLACK

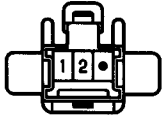

D13 BLACK

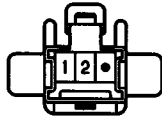

J12

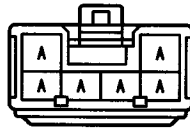

(HINT:SEE PAGE 7)

P 6



P 7



P 8



P 9

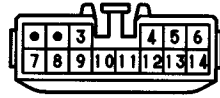

P10 GRAY



P11 GRAY



P12 GRAY

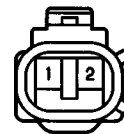

P13 GRAY



T 7 (A) ORANGE

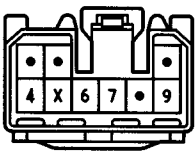

T 8 (B) ORANGE

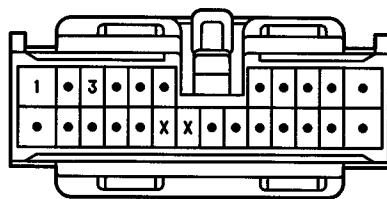

# THEFT DETERRENT AND DOOR LOCK CONTROL

FROM POWER SOURCE SYSTEM (SEE PAGE 58)

FROM POWER SOURCE SYSTEM (SEE PAGE 58)

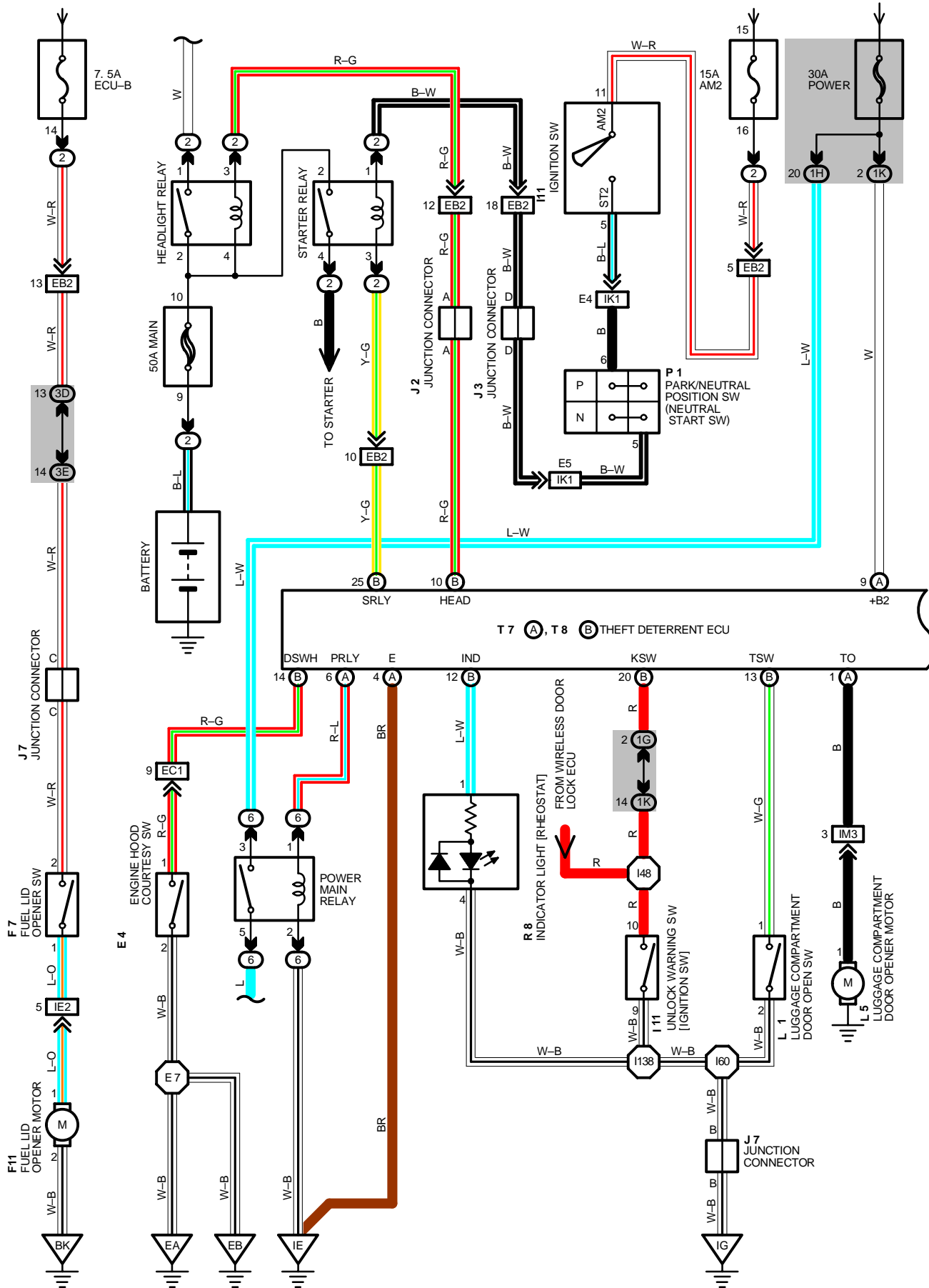

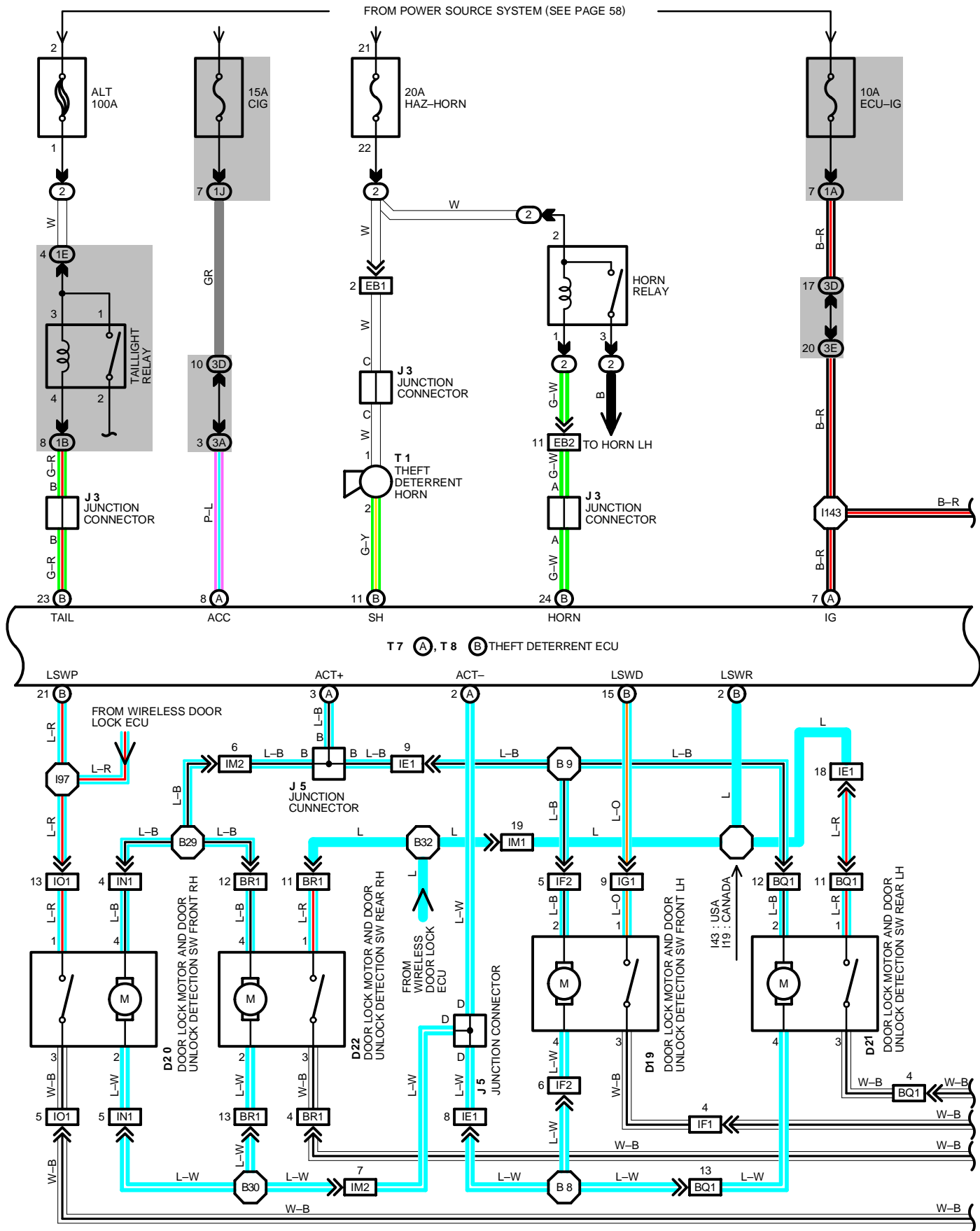

# THEFT DETERRENT AND DOOR LOCK CONTROL

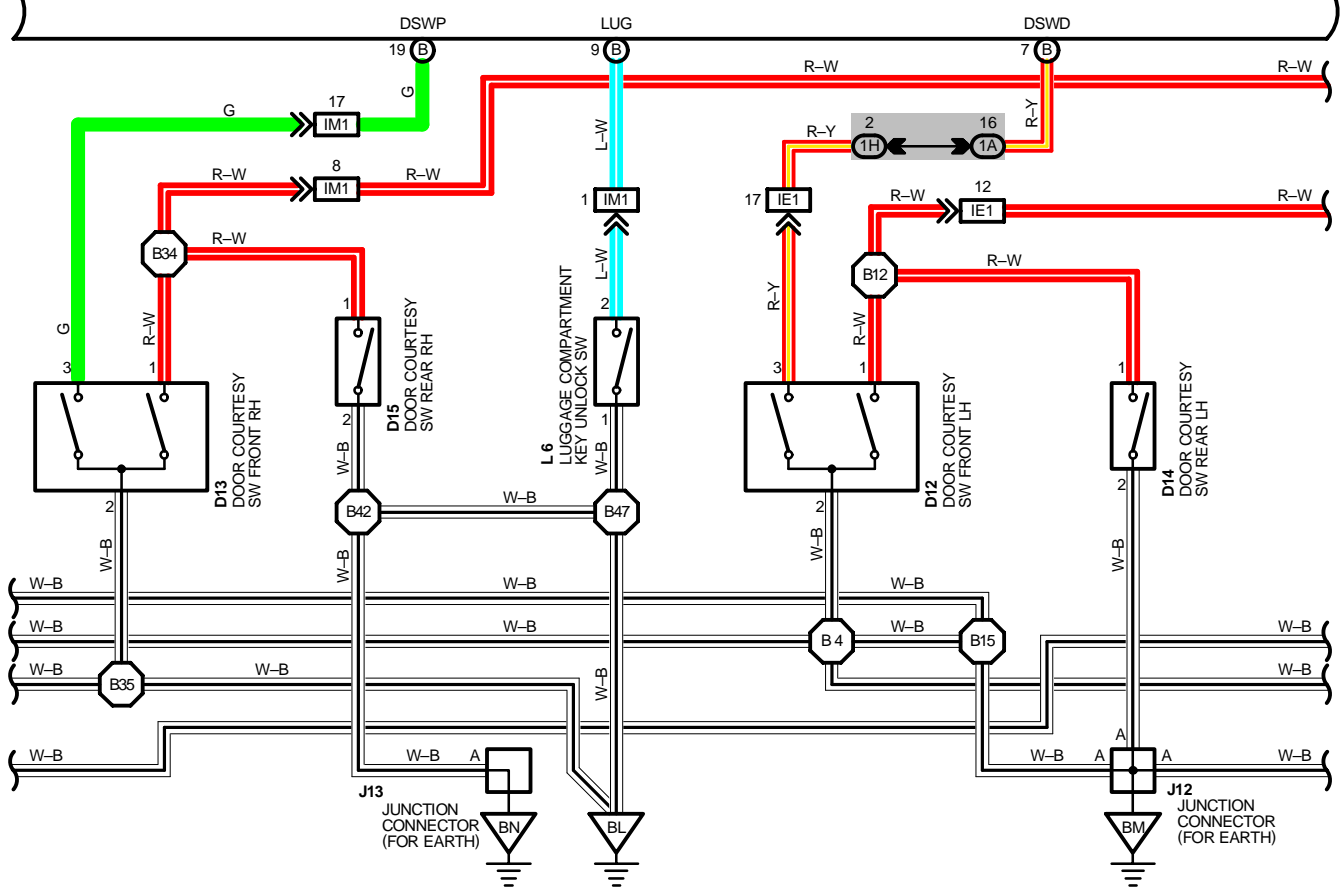
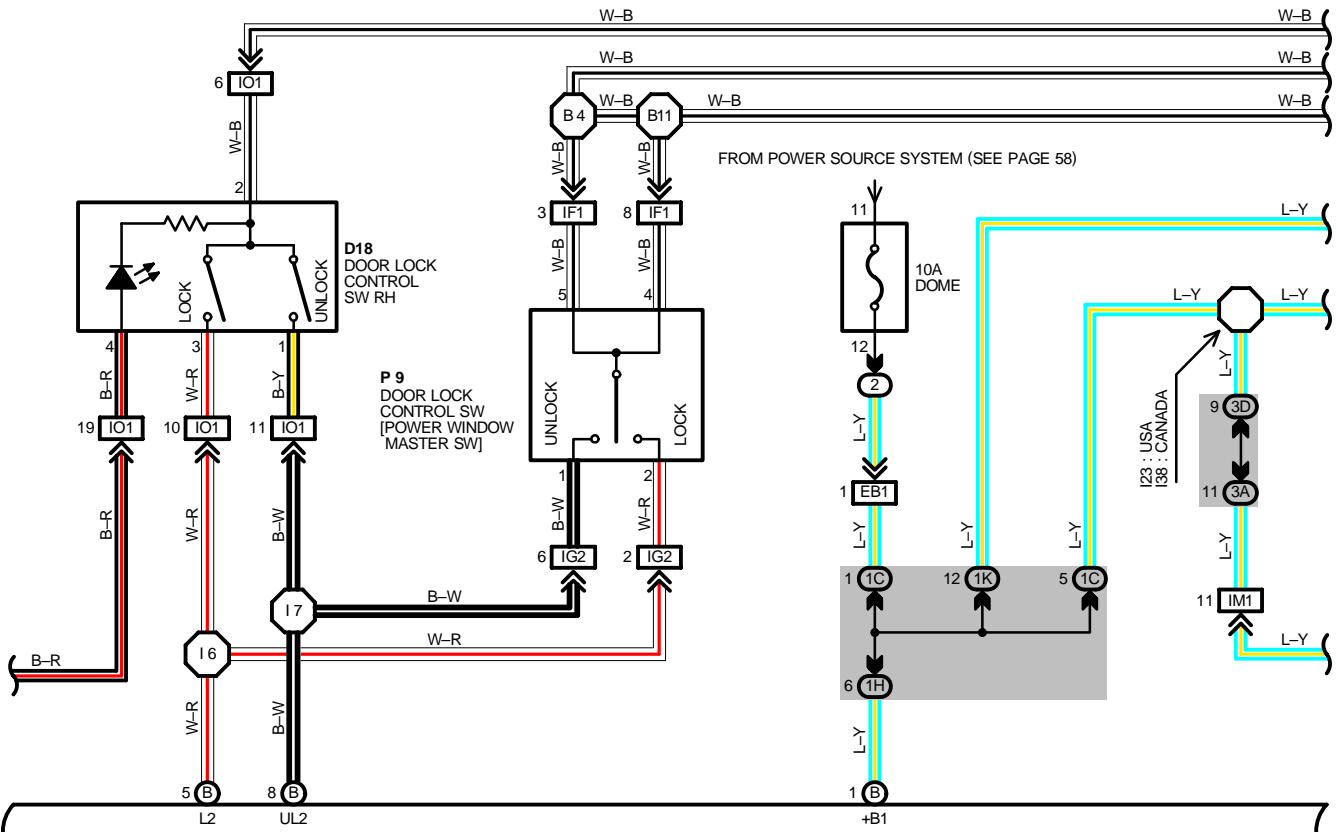





# THEFT DETERRENT AND DOOR LOCK CONTROL

## SYSTEM OUTLINE

CURRENT ALWAYS FLOWS TO **TERMINAL (A)9** OF THE THEFT DETERRENT ECU THROUGH THE **POWER FUSE**, AND TO **TERMINAL (B)1** THROUGH THE **DOME FUSE**.

WHEN THE IGNITION SW TURNED ON. THE CURRENT FLOWING THROUGH THE **ECU-IG FUSE** → **TERMINAL (A)7** OF THE ECU → **TERMINAL (A)6** FLOWS THROUGH THE COIL SIDE OF THE POWER MAIN RELAY TO **GROUND**, CAUSING THE RELAY TO OPERATE. THE CURRENT FLOWING THROUGH THE **POWER FUSE** FLOWS TO THE DOOR LOCK CONTROL SWITCHES, CAUSING THE INDICATOR LIGHT TO LIGHT UP.

### 1. MANUAL LOCK OPERATION

WHEN THE DOOR LOCK CONTROL SW OR KEY SW ARE PUSHED TO LOCK POSITION, A LOCK SIGNAL IS INPUT TO **TERMINAL (B)5**, **(B)22** (FOR KEY SW) OF THE THEFT DETERRENT ECU AND CAUSES THE ECU TO FUNCTION. CURRENT FLOWS FROM **TERMINAL (A)9** OF THE ECU → **TERMINAL (A)3** → **TERMINAL 2 (LH)**, **TERMINAL 4 (RH)** OF THE DOOR LOCK MOTORS → **TERMINAL 4 (LH)**, **TERMINAL 2 (RH)** → **TERMINAL (A)2** OF THE ECU → **TERMINAL (A)4** → TO **GROUND** AND THE DOOR LOCK MOTOR CAUSES THE DOOR TO LOCK.

### 2. MANUAL UNLOCK OPERATION

WHEN THE DOOR LOCK CONTROL SW OR KEY SW ARE PUSHED TO UNLOCK POSITION, AN UNLOCK SIGNAL IS INPUT TO **TERMINAL (A)8**, **(B)6** (FOR KEY SW LH) OR **(B)16** (FOR KEY SW RH) OF THE THEFT DETERRENT ECU AND CAUSES TO FUNCTION. CURRENT FLOWS FROM **TERMINAL (A)9** OF THE ECU → **TERMINAL (A)2** → **TERMINAL 4 (LH)**, **TERMINAL 2 (RH)** OF THE DOOR LOCK MOTORS → **TERMINAL 2 (LH)**, **TERMINAL 4 (RH)** → **TERMINAL (A)3** OF THE ECU → **TERMINAL (A)4** → TO **GROUND** AND THE DOOR LOCK MOTOR CAUSES THE DOOR TO UNLOCK.

WHEN UNLOCK OPERATION OCCURS USING THE LH DOOR KEY SW, DOING THE UNLOCK OPERATION ONCE UNLOCKS ONLY THE DRIVER'S DOOR. TO UNLOCK ALL THE OTHER DOORS TOGETHER, UNLOCK OPERATION MUST BE DONE AGAIN WITHIN 3SECONDS OF THE FIRST OPERATION.

### 3. IGNITION KEY REMINDER OPERATION

\* OPERATION OF DOOR LOCK BUTTON (OPERATION OF DOOR LOCK MOTORS)

WHEN THE IGNITION KEY IS IN THE CYLINDER (UNLOCK WARNING SW ON) AND THE DOOR IS OPENED AND LOCKED USING DOOR LOCK BUTTON (DOOR LOCK MOTOR), THE DOOR IS LOCKED ONCE BUT EACH DOOR IS UNLOCKED SOON BY THE OPERATION OF THE ECU. AS A RESULT OF ECU ACTIVATION, THE CURRENT FLOWS FROM **TERMINAL (A)9** OF THE ECU → **TERMINAL (A)2** → **TERMINAL 4 (LH)**, **TERMINAL 2 (RH)** OF THE DOOR LOCK MOTORS → **TERMINAL 2 (LH)**, **TERMINAL 4 (RH)** → **TERMINAL (A)3** OF THE ECU → **TERMINAL (A)4** → TO **GROUND** AND CAUSES ALL THE DOOR LOCK CONTROL SW AND DOOR LOCK KEY SW.

\* KEY LESS LOCK OPERATION

WHEN THE IGNITION KEY IS STILL INSERTED IN THE CYLINDER (UNLOCK WARNING SW ON), THE DOOR IS OPEN AND UNLOCK OPERATION IS PREVENTED BY KEEPING THE DOOR LOCK BUTTON PRESSED TO THE LOCK SIDE, THE DOOR IS KEPT IN THE LOCK CONDITION. IF THE DOOR IS THEN CLOSED, A SIGNAL IS INPUT TO THE ECU FROM THE DOOR COURTESY SW. THIS ACTIVATES THE ECU AND EACH DOOR IS UNLOCKED.

## SERVICE HINTS

**D12, D13, D14, D15 DOOR COURTESY SW FRONT LH, RH, REAR LH, RH**

1-2: CLOSED WITH DOOR OPEN

**D16, D17 DOOR KEY LOCK AND UNLOCK SW LH, RH**

1-2: CLOSED WITH DOOR LOCK CYLINDER UNLOCK WITH KEY

3-2: CLOSED WITH DOOR LOCK CYLINDER LOCKED WITH KEY

**D19, D20, D21, D22 DOOR LOCK MOTOR AND DOOR UNLOCK DETECTION SW FRONT LH, RH, REAR LH, RH**

1-3: CLOSED WITH **UNLOCK** POSITION

**E 4 ENGINE HOOD COURTESY SW**

1-2: CLOSED WITH ENGINE HOOD OPEN

**I11 UNLOCK WARNING SW [IGNITION SW]**

10-9: CLOSED WITH IGNITION KEY IN CYLINDER

**L 6 LUGGAGE COMPARTMENT KEY UNLOCK SW**

2-1: CLOSED WITH DOOR LOCK CYLINDER UNLOCK WITH KEY

**L 8 LUGGAGE COMPARTMENT LIGHT SW**

1-GROUND: CLOSED WITH DOOR OPEN

**T 7(A), T 8(B) THEFT DETERRENT ECU**

- (B) 9-GROUND : CONTINUITY WITH LUGGAGE COMPARTMENT DOOR TO **UNLOCK** POSITION
- (B) 3-GROUND : CONTINUITY WITH DOOR OPEN
- (B) 14-GROUND : CONTINUITY WITH ENGINE HOOD OPEN
- (B) 4-GROUND : CONTINUITY WITH LUGGAGE COMPARTMENT DOOR OPEN
- (B) 8-GROUND : CONTINUITY WITH DOOR LOCK CONTROL SW TO **UNLOCK** POSITION
- (B) 5-GROUND : CONTINUITY WITH DOOR LOCK CONTROL SW TO **LOCK** POSITION
- (B) 2-GROUND : CONTINUITY WITH REAR DOOR TO **UNLOCK** POSITION
- (B) 25-GROUND : APPROX. 12 VOLTS WITH SHIFT LEVER IN **N** OR **P** POSITION AND IGNITION SW AT **ST** POSITION
- (A) 7-GROUND : APPROX. 12 VOLTS WITH IGNITION SW AT **ON** POSITION
- (B) 20-GROUND : CONTINUITY WITH IGNITION KEY IN CYLINDER
- (B) 15-GROUND : CONTINUITY WITH FRONT LH DOOR TO **UNLOCK** POSITION
- (B) 21-GROUND : CONTINUITY WITH FRONT RH DOOR TO **UNLOCK** POSITION
- (B) 6-GROUND : CONTINUITY WITH DOOR KEY LOCK SW LH TO **UNLOCK** POSITION
- (B) 16-GROUND : CONTINUITY WITH DOOR KEY LOCK SW RH TO **UNLOCK** POSITION
- (B) 22-GROUND : CONTINUITY WITH DOOR KEY LOCK SW TO **LOCK** POSITION
- (A) 4-GROUND : ALWAYS CONTINUITY
- (B) 1-GROUND : ALWAYS APPROX. 12 VOLTS

**○ : PARTS LOCATION**

CODE		SEE PAGE	CODE	SEE PAGE	CODE	SEE PAGE
C10	A	28	D22	30	L 5	30
C11	B	28	E 4	26	L 6	30
D12		30	F 7	28	L 7	30
D13		30	F11	30	L 8	30
D14		30	I11	29	P 1	27
D15		30	J 2	29	P 9	31
D16		30	J 3	29	R 8	29
D17		30	J 5	29	T 1	27
D18		30	J 7	29	T 7	A 29
D19		30	J12	30	T 8	B 29
D20		30	J13	30		
D21		30	L 1	29		

**○ : RELAY BLOCKS**

CODE	SEE PAGE	RELAY BLOCKS (RELAY BLOCK LOCATION)
2	19	R/B NO. 2 (ENGINE COMPARTMENT LEFT)
6	24	R/B NO. 6 (LEFT KICK PANEL)

**○ : JUNCTION BLOCK AND WIRE HARNESS CONNECTOR**

CODE	SEE PAGE	JUNCTION BLOCK AND WIRE HARNESS (CONNECTOR LOCATION)
1A	20	COWL WIRE AND J/B NO. 1 (LEFT KICK PANEL)
1B		
1C		
1E		
1G		
1H		
1J		
1K		
3A	22	COWL WIRE AND J/B NO. 3 (BEHIND THE INSTRUMENT PANEL CENTER)
3D		
3E		

# THEFT DETERRENT AND DOOR LOCK CONTROL

## : CONNECTOR JOINING WIRE HARNESS AND WIRE HARNESS

CODE	SEE PAGE	JOINING WIRE HARNESS AND WIRE HARNESS (CONNECTOR LOCATION)
EB1	34	COWL WIRE AND R/B NO. 2 WIRE (INSIDE OF R/B NO. 2)
EB2		
EC1	34	COWL WIRE AND ENGINE ROOM MAIN WIRE (INSIDE OF R/B NO. 2)
IE1	36	COWL WIRE AND FLOOR NO. 2 WIRE (LEFT KICK PANEL)
IE2		
IF1	36	FRONT DOOR LH WIRE AND FLOOR NO. 2 WIRE (LEFT KICK PANEL)
IF2		
IG1	36	FRONT DOOR LH WIRE AND COWL WIRE (LEFT KICK PANEL)
IG2		
IK1	38	ENGINE WIRE AND COWL WIRE (UNDER THE GLOVE BOX)
IM1	38	COWL WIRE AND FLOOR NO. 1 WIRE (RIGHT KICK PANEL)
IM2		
IM3		
IN1	38	FRONT DOOR RH WIRE AND FLOOR NO. 1 WIRE (RIGHT KICK PANEL)
IO1	38	FRONT DOOR RH WIRE AND COWL WIRE (RIGHT KICK PANEL)
BQ1	40	REAR DOOR LH WIRE AND FLOOR NO. 2 WIRE (LEFT CENTER PILLAR)
BR1	40	REAR DOOR RH WIRE AND FLOOR NO. 1 WIRE (RIGHT CENTER PILLAR)

## : GROUND POINTS

CODE	SEE PAGE	GROUND POINTS LOCATION
EA	34	FRONT SIDE OF RIGHT FENDER
EB	34	FRONT SIDE OF LEFT FENDER
IE	36	LEFT KICK PANEL
IG	36	BEHIND GLOVE BOX
IH	36	RIGHT KICK PANEL
BK	40	UNDER THE FRONT SEAT LH
BL	40	UNDER THE FRONT SEAT RH
BM	40	LUGGAGE ROOM LEFT
BN	40	LUGGAGE ROOM RIGHT

## : SPLICE POINTS

CODE	SEE PAGE	WIRE HARNESS WITH SPLICE POINTS	CODE	SEE PAGE	WIRE HARNESS WITH SPLICE POINTS
E 7	34	ENGINE ROOM MAIN WIRE	I138	38	COWL WIRE
I 6			I143		
I 7	38	COWL WIRE	B 4	40	FLOOR NO. 2 WIRE
I11			B 8		
I19			B 9		
I23			B11		
I32			B12		
I38			B15	FLOOR NO. 1 WIRE	
I43			B29		40
I44			B30		
I48			B32		
I60			B34		
I95	B35				
I96			B41		
I97			B42		
I102			B47		

C10 (A) ORANGE

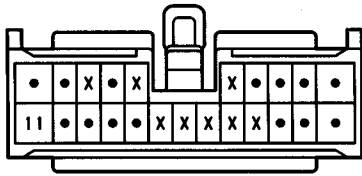

C11 (B) GRAY

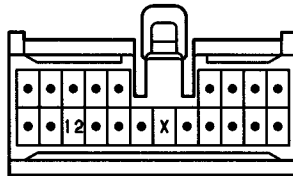

D12, D13 BLACK

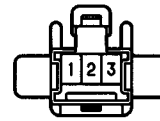

D14, D15 BLACK

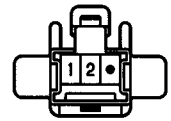

D16, D17



D18



D19, D20, D21, D22



E 4 BLACK



F 7 GREEN

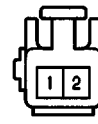

F11 GRAY

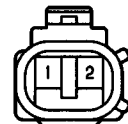

I11 BLACK

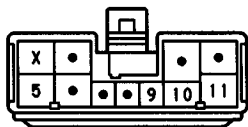

J 2

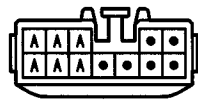

(HINT:SEE PAGE 7)

J 3 BLACK



(HINT:SEE PAGE 7)

J 5 BLACK

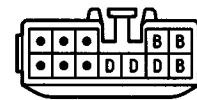

(HINT:SEE PAGE 7)

J 7 GRAY

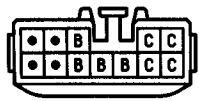

(HINT:SEE PAGE 7)

J12, J13

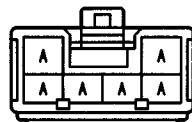

(HINT:SEE PAGE 7)

L 1



L 5



L 6

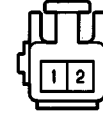

L 7 GRAY



L 8 GRAY



P 1 GRAY

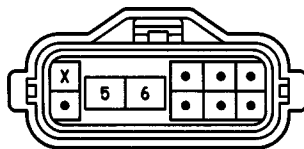

P 9

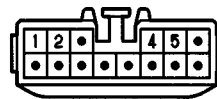

R 8



T 1 BLACK



T 7 (A) ORANGE

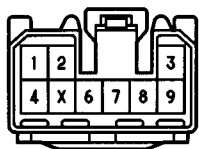

T 8 (B) ORANGE

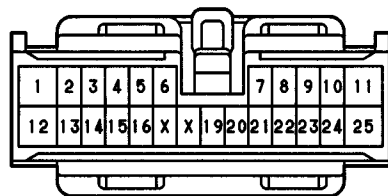

# WIRELESS DOOR LOCK CONTROL

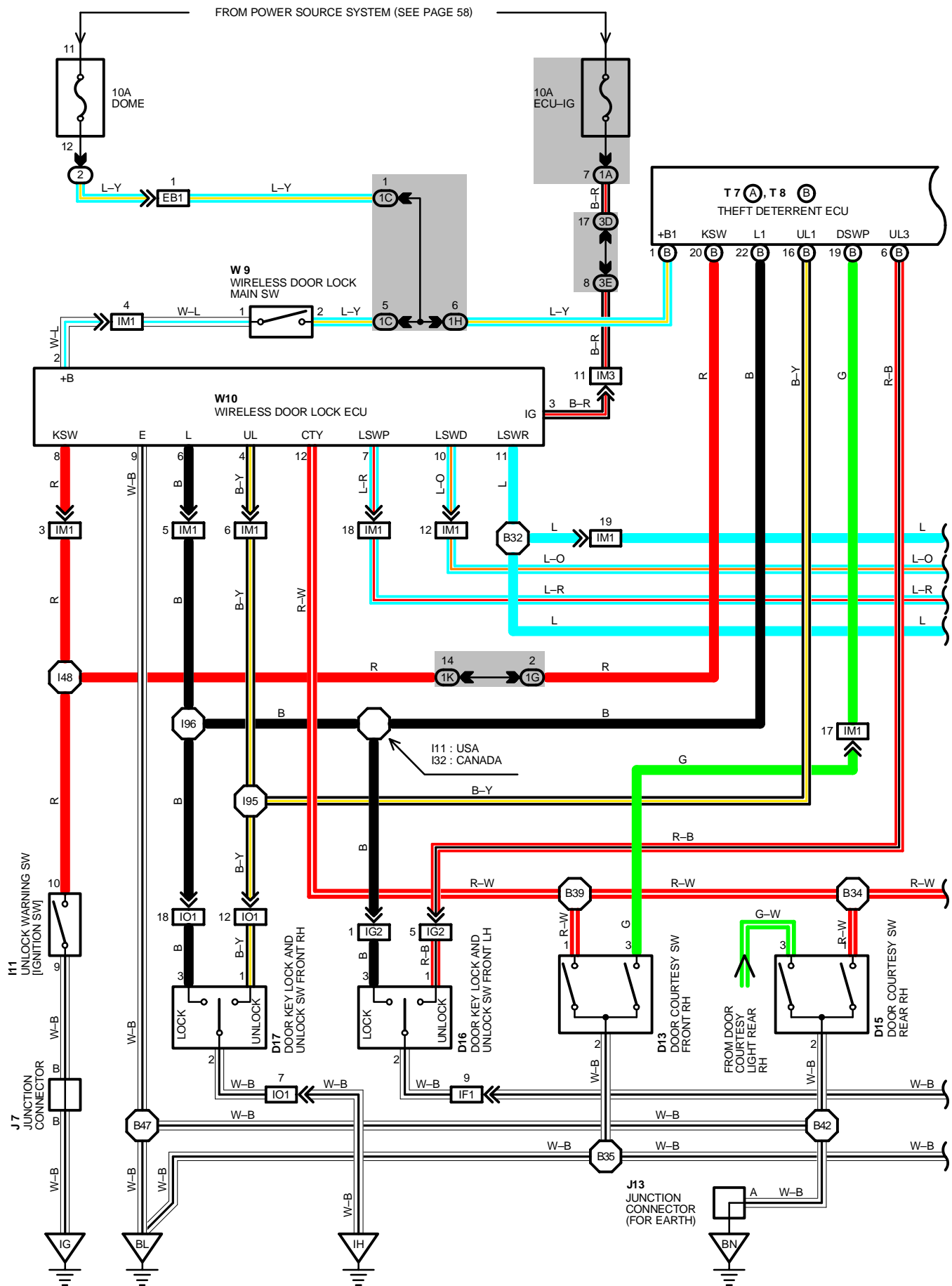

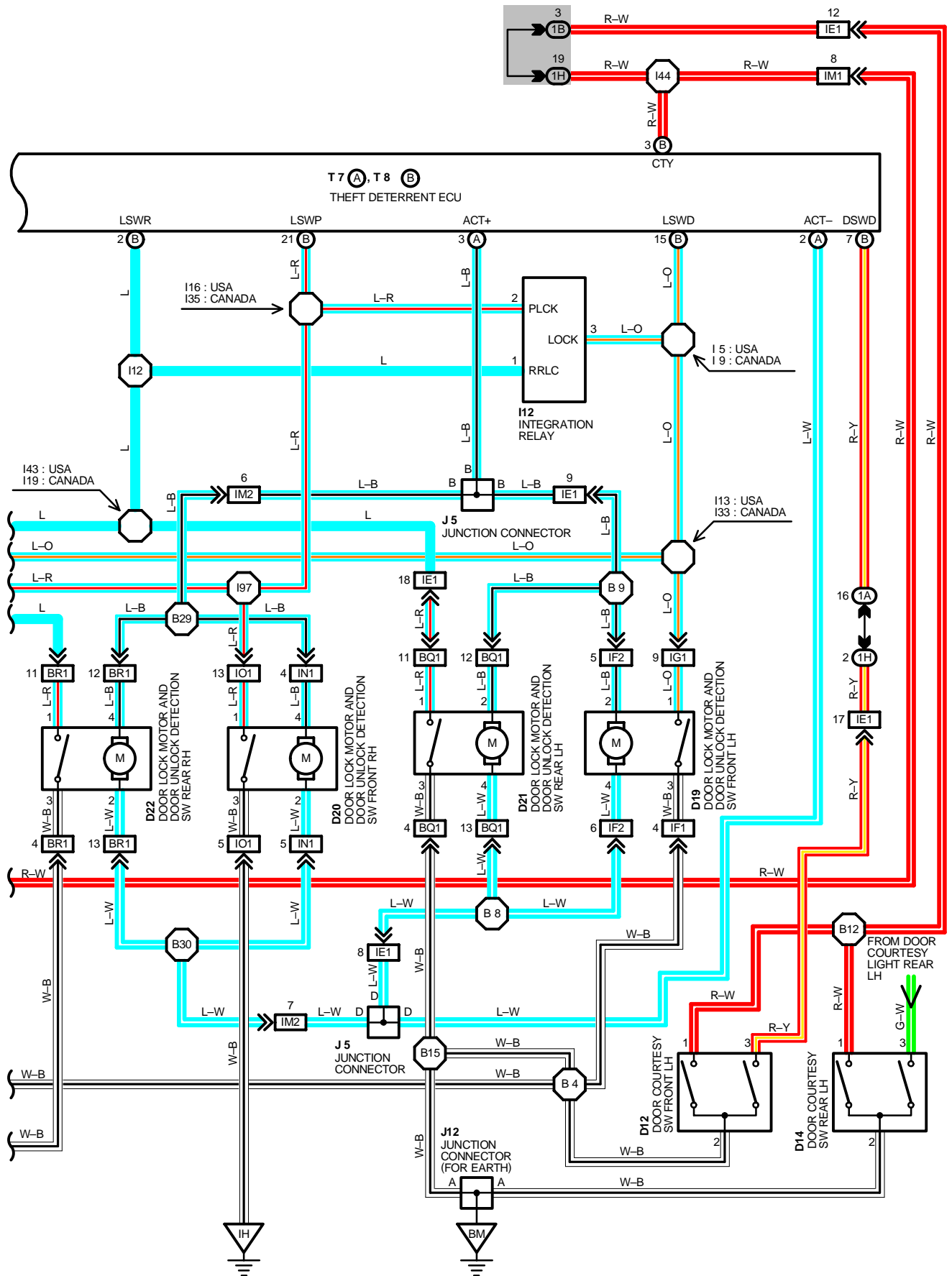

# WIRELESS DOOR LOCK CONTROL

## SYSTEM OUTLINE

DOOR LOCK CONTROL (LOCK AND UNLOCK) IS PERFORMED BY REMOTE CONTROL, WITHOUT THE IGNITION KEY INSERTED IN THE DOOR KEY CYLINDER, USING LOW-POWER RADIO WAVES EMITTED BY A TRANSMITTER BUILT INTO IGNITION KEY.

### 1. WIRELESS DOOR LOCK OR UNLOCK NORMAL OPERATION

WITH THE WIRELESS DOOR LOCK MAIN SW ON, THE IGNITION KEY NOT INSERTED INTO THE IGNITION KEY CYLINDER (UNLOCK WARNING SW OFF) AND ALL THE DOORS COMPLETELY CLOSED, WHEN THE SW (TRANSMITTER) ON THE IGNITION KEY IS PUSHED, THE WIRELESS DOOR LOCK ECU RECEIVES THE ELECTRICAL WAVES FROM THE IGNITION KEY (TRANSMITTER), CAUSING IT TO OPERATE.

AS A RESULT, THE ECU JUDGES WHETHER THE DOOR IS LOCKED OR UNLOCKED BASED ON THE SIGNAL FROM THE DOOR LOCK MOTOR. AND SENDS A SIGNAL TO THE DOOR LOCK ECU TO SW THE CONDITION FROM LOCK TO UNLOCK OR VICE VERSA, CAUSING THE DOOR LOCK MOTOR TO OPERATE (FOR THE CURRENT FLOW DURING LOCK AND UNLOCK REFER TO THE DOOR LOCK CONTROL SYSTEM.)

### 2. AUTO LOCK OPERATION

AFTER PUSHING THE IGNITION KEY SW (TRANSMITTER) TO UNLOCK ALL THE DOORS, IF A DOOR IS NOT OPENED WITHIN 30 SECONDS, ALL OF THE DOORS ARE AUTOMATICALLY LOCKED AGAIN.

### 3. WIRELESS DOOR LOCK STOP FUNCTION

IF A DOOR IS OPEN (DOOR COURTESY SW ON), A SIGNAL IS INPUT FROM THE DOOR COURTESY SW TO THE WIRELESS DOOR LOCK ECU, STOPPING WIRELESS DOOR LOCK OR UNLOCK.

IF THE IGNITION KEY IS IN THE IGNITION KEY CYLINDER (UNLOCK WARNING SW ON). THE UNLOCK WARNING SW INPUT A SIGNAL TO THE WIRELESS DOOR LOCK ECU, STOPPING WIRELESS DOOR LOCK OR UNLOCK.

### 4. DOOR LOCK MOTOR PROTECTIVE FUNCTION

IF THE DOOR LOCK OR UNLOCK CONDITION DOES NOT CHANGE AFTER WIRELESS DOOR LOCK OR UNLOCK OPERATION, THE DOOR LOCK ECU SENDS CURRENT TEN TIMES TO THE DOOR LOCK MOTOR. IF THE DOOR LOCK CONDITION STILL HAS NOT CHANGED AS A RESULT THE WIRELESS DOOR LOCK ECU STOPS RECEPTION AND STOPS DOOR LOCK AND UNLOCK FUNCTION.

BY MANUALLY OPERATION THE DOOR LOCK OR UNLOCK, THE STOP CONDITION OF THE WIRELESS DOOR LOCK FUNCTION IS RELEASED.

## SERVICE HINTS

### D12, D13, D14, D15 DOOR COURTESY SW FRONT LH, RH, REAR LH, RH

1-2, 3-2: CLOSED WITH DOOR OPENED

### I11 UNLOCK WARNING SW [IGNITION SW]

10-9: CLOSED WITH IGNITION KEY IN CYLINDER

### W10 WIRELESS DOOR LOCK ECU

1-GROUND: APPROX. 12 VOLTS WITH WIRELESS DOOR LOCK MAIN SW ON

7-GROUND: ALWAYS CONTINUITY

10-GROUND: CONTINUITY WITH EACH DOOR OPENED

6-GROUND: CONTINUITY WITH IGNITION KEY IN CYLINDER

## ○ : PARTS LOCATION

CODE	SEE PAGE	CODE	SEE PAGE	CODE	SEE PAGE
D12	30	D20	30	J12	30
D13	30	D21	30	J13	30
D14	30	D22	30	T 7	A 29
D15	30	I11	29	T 8	B 29
D16	30	I12	29	W 9	29
D17	30	J 5	29	W10	31
D19	30	J 7	29		

## ○ : RELAY BLOCKS

CODE	SEE PAGE	RELAY BLOCKS (RELAY BLOCK LOCATION)
2	19	R/B NO. 2 (ENGINE COMPARTMENT LEFT)

## ○ : JUNCTION BLOCK AND WIRE HARNESS CONNECTOR

CODE	SEE PAGE	JUNCTION BLOCK AND WIRE HARNESS (CONNECTOR LOCATION)
1A	20	COWL WIRE AND J/B NO. 1 (LEFT KICK PANEL)
1B		
1C		
1G		
1H		
1K		



**□ : CONNECTOR JOINING WIRE HARNESS AND WIRE HARNESS**

CODE	SEE PAGE	JOINING WIRE HARNESS AND WIRE HARNESS (CONNECTOR LOCATION)
EB1	34	COWL WIRE AND R/B NO. 2 WIRE (INSIDE OF R/B NO. 2)
IE1	36	COWL WIRE AND FLOOR NO. 2 WIRE (LEFT KICK PANEL)
IF1	36	FRONT DOOR LH WIRE AND FLOOR NO. 2 WIRE (LEFT KICK PANEL)
IF2		
IG1	36	FRONT DOOR LH WIRE AND COWL WIRE (LEFT KICK PANEL)
IG2		
IM1	38	COWL WIRE AND FLOOR NO. 1 WIRE (RIGHT KICK PANEL)
IM2		
IM3		
IN1	38	FRONT DOOR RH WIRE AND FLOOR NO. 1 WIRE (RIGHT KICK PANEL)
IO1	38	FRONT DOOR RH WIRE AND COWL WIRE (RIGHT KICK PANEL)
BQ1	40	REAR DOOR LH WIRE AND FLOOR NO. 2 WIRE (LEFT KICK PANEL)
BR1	40	REAR DOOR RH WIRE AND FLOOR NO. 1 WIRE (RIGHT CENTER PILLAR)

**▽ : GROUND POINTS**

CODE	SEE PAGE	GROUND POINTS LOCATION
IG	36	BEHIND GLOVE BOX
IH	36	RIGHT KICK PANEL
BL	40	UNDER THE FRONT SEAT RH
BM	40	LUGGAGE ROOM LEFT
BN	40	LUGGAGE ROOM RIGHT

**○ : SPLICE POINTS**

CODE	SEE PAGE	WIRE HARNESS WITH SPLICE POINTS	CODE	SEE PAGE	WIRE HARNESS WITH SPLICE POINTS
I5	38	COWL WIRE	I97	38	COWL WIRE
I9			B4	40	FLOOR NO. 2 WIRE
I11			B8		
I12			B9		
I13			B12		
I16			B15	40	FLOOR NO. 1 WIRE
I19			B29		
I32			B30		
I33			B32		
I35			B34		
I43			B35		
I44			B39		
I48			B42		
I95			B47		
I96					

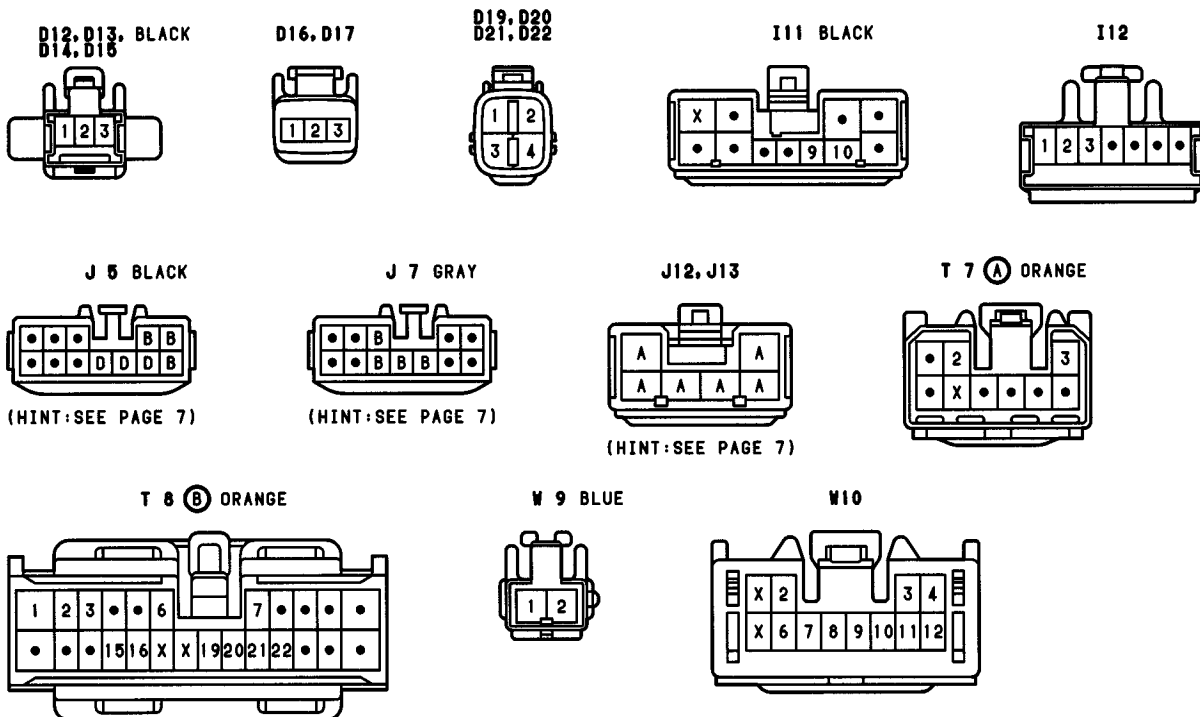

# CIGARETTE LIGHTER AND CLOCK

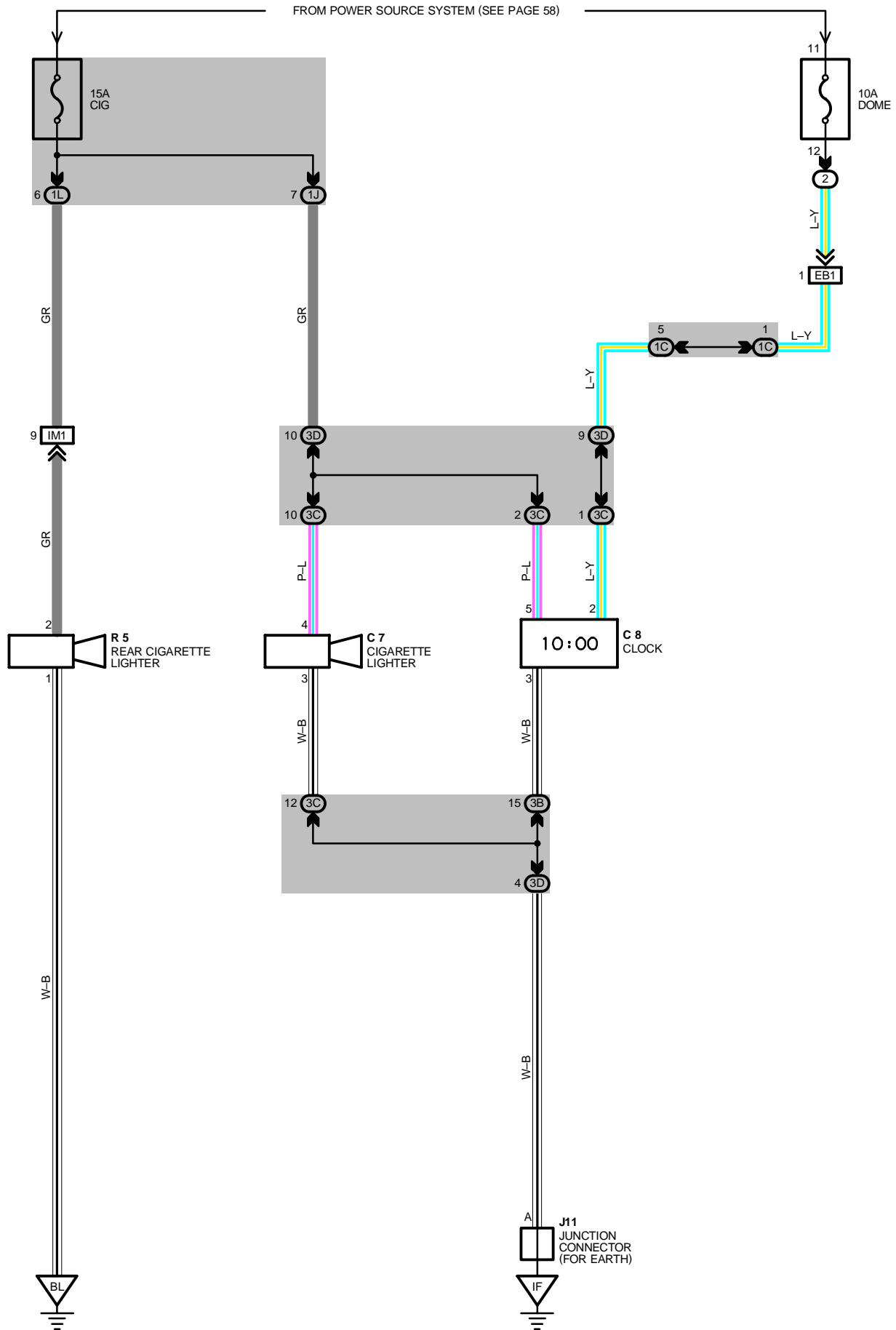

## SERVICE HINTS

### C7 CIGARETTE LIGHTER

- 4-GROUND : APPROX. 12 VOLTS WITH IGNITION SW AT **ACC** OR **ON** POSITION
- 3-GROUND : ALWAYS CONTINUITY

### R 5 REAR CIGARETTE LIGHTER

- 2-GROUND : APPROX. 12 VOLTS WITH IGNITION SW AT **ACC** OR **ON** POSITION
- 1-GROUND : ALWAYS CONTINUITY

### C 8 CLOCK

- 2-GROUND : APPROX. 12 VOLTS (POWER FOR CLOCK)
- 5-GROUND : APPROX. 12 VOLTS WITH IGNITION SW AT **ACC** OR **ON** POSITION  
(POWER FOR INDICATION)
- 3-GROUND : ALWAYS CONTINUITY

## ○ : PARTS LOCATION

CODE	SEE PAGE	CODE	SEE PAGE	CODE	SEE PAGE
C 7	28	J11	29		
C 8	28	R 5	29		

## ○ : RELAY BLOCKS

CODE	SEE PAGE	RELAY BLOCKS (RELAY BLOCK LOCATION)
2	19	R/B NO. 2 (ENGINE COMPARTMENT LEFT)

## ○ : JUNCTION BLOCK AND WIRE HARNESS CONNECTOR

CODE	SEE PAGE	JUNCTION BLOCK AND WIRE HARNESS (CONNECTOR LOCATION)
1C	20	COWL WIRE AND J/B NO. 1 (LEFT KICK PANEL)
1J		
1L		
3B	22	INSTRUMENT PANEL WIRE AND J/B NO. 3 (BEHIND THE INSTRUMENT PANEL CENTER)
3C		
3D	22	COWL WIRE AND J/B NO. 3 (BEHIND THE INSTRUMENT PANEL CENTER)

## ▽ : GROUND POINTS

CODE	SEE PAGE	GROUND POINTS LOCATION
IF	36	BEHIND COMBINATION METER
BL	40	UNDER THE FRONT SEAT RH

C 7

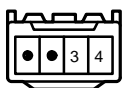

C 8 BLACK

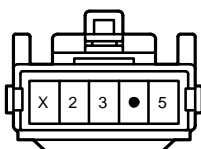

J11

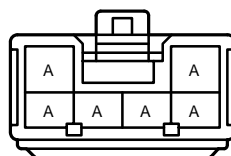

R 5

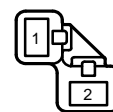

# CELLULAR MOBILE TELEPHONE

FROM POWER SOURCE SYSTEM (SEE PAGE 58)

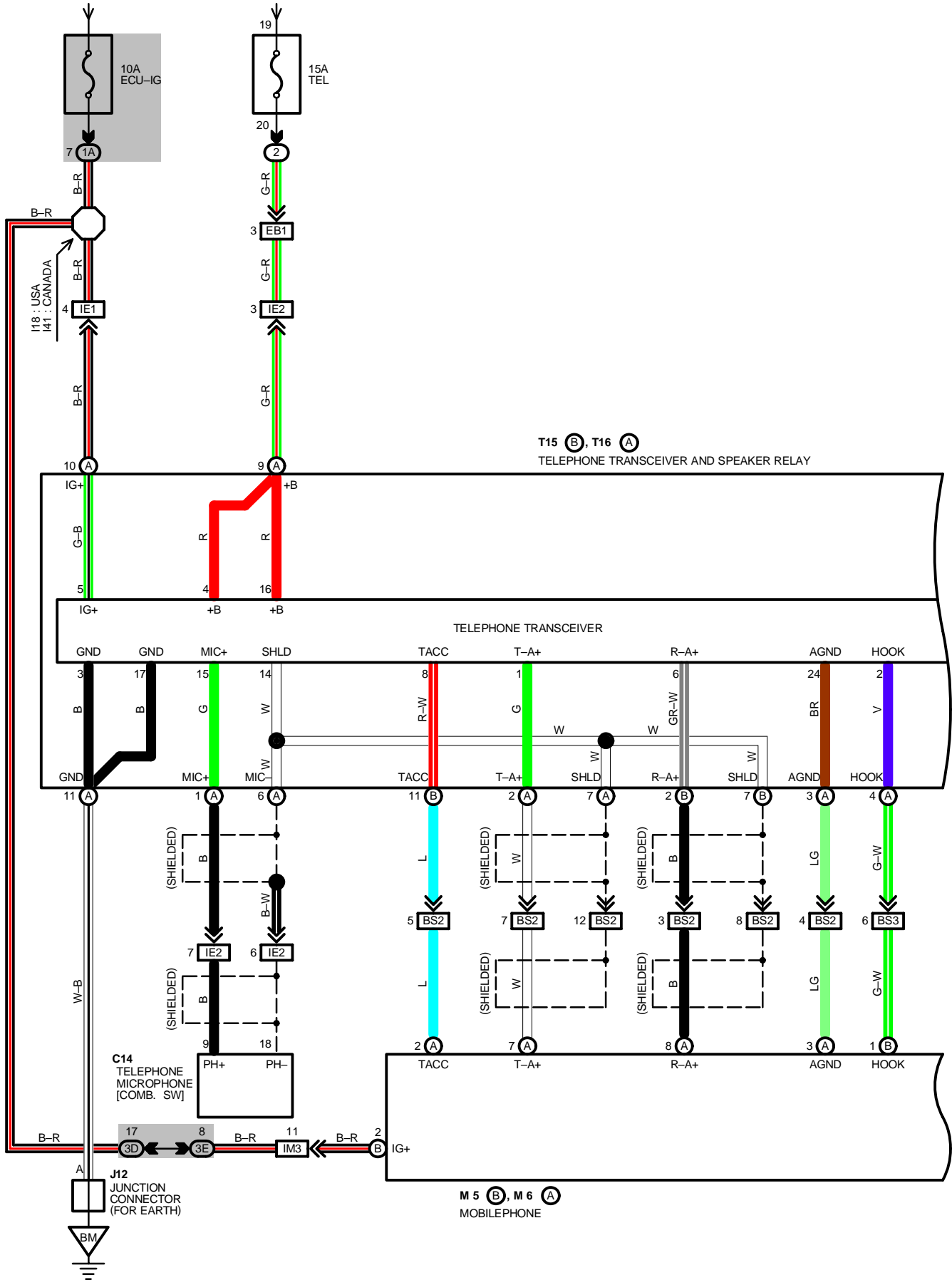

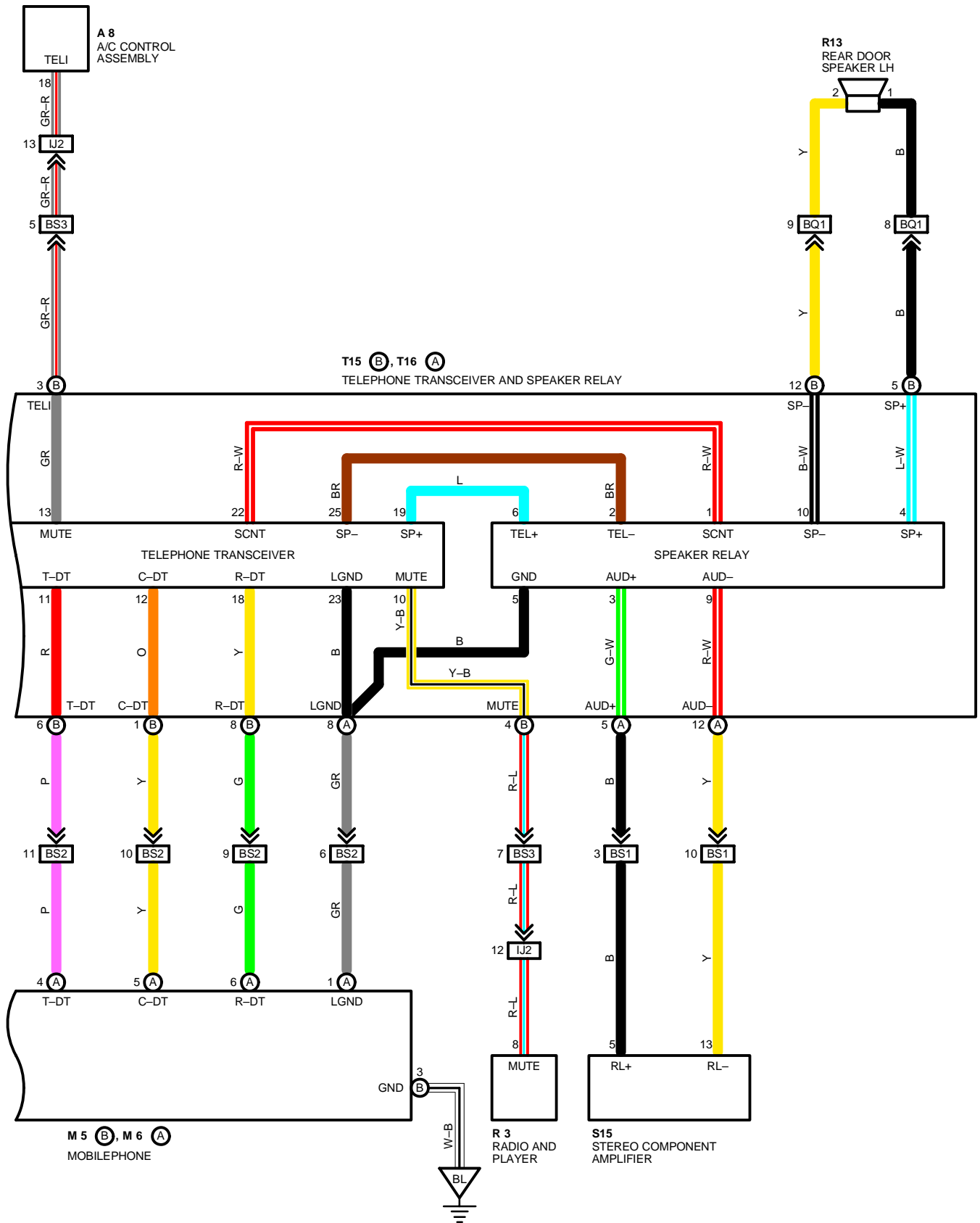

# CELLULAR MOBILE TELEPHONE

## SERVICE HINTS

### T15(B), T16(A) TELEPHONE TRANSCEIVER AND SPEAKER RELAY

- (A) 9-GROUND : ALWAYS APPROX. 12 VOLTS
- (A) 10-GROUND : APPROX. 12 VOLTS WITH IGNITION SW AT ON POSITION
- (A) 11-GROUND : ALWAYS CONTINUITY

## ○ : PARTS LOCATION

CODE	SEE PAGE	CODE	SEE PAGE	CODE	SEE PAGE
A 8	28	M 6	A 29	T15	B 31
C14	28	R 3	29	T16	A 31
J12	30	R13	31		
M 5	B 29	S15	31		

## ○ : RELAY BLOCKS

CODE	SEE PAGE	RELAY BLOCKS (RELAY BLOCK LOCATION)
2	19	R/B NO. 2 (ENGINE COMPARTMENT LEFT)

## ○ : JUNCTION BLOCK AND WIRE HARNESS CONNECTOR

CODE	SEE PAGE	JUNCTION BLOCK AND WIRE HARNESS (CONNECTOR LOCATION)
1A	20	COWL WIRE AND J/B NO. 1 (LEFT KICK PANEL)
3D	22	COWL WIRE AND J/B NO. 3 (BEHIND THE INSTRUMENT PANEL CENTER)
3E		

## □ : CONNECTOR JOINING WIRE HARNESS AND WIRE HARNESS

CODE	SEE PAGE	JOINING WIRE HARNESS AND WIRE HARNESS (CONNECTOR LOCATION)
EB1	34	COWL WIRE AND R/B NO. 2 WIRE (INSIDE OF R/B NO. 2)
IE1	36	COWL WIRE AND FLOOR NO. 2 WIRE (LEFT KICK PANEL)
IE2		
IJ2	36	INSTRUMENT PANEL WIRE AND FLOOR NO. 1 WIRE (UNDER THE INSTRUMENT PANEL BRACE LH)
IM3	38	COWL WIRE AND FLOOR NO. 1 WIRE (RIGHT KICK PANEL)
BQ1	40	REAR DOOR LH WIRE AND FLOOR NO. 2 WIRE (LEFT CENTER PANEL)
BS1	40	FLOOR NO. 1 WIRE AND FLOOR NO. 2 WIRE (UNDER THE LEFT SIDE OF REAR SEAT CUSHION)
BS2		
BS3		

## ▽ : GROUND POINTS

CODE	SEE PAGE	GROUND POINTS LOCATION
BL	40	UNDER THE FRONT SEAT RH
BM	40	LUGGAGE ROOM LEFT

## ○ : SPLICE POINTS

CODE	SEE PAGE	WIRE HARNESS WITH SPLICE POINTS	CODE	SEE PAGE	WIRE HARNESS WITH SPLICE POINTS
I18	38	COWL WIRE	I41	38	COWL WIRE

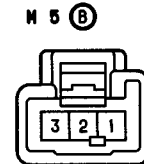
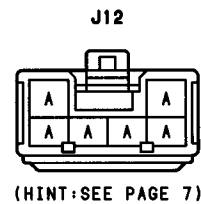
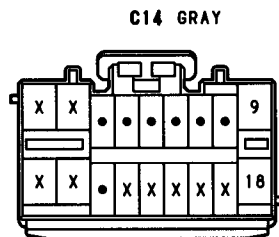
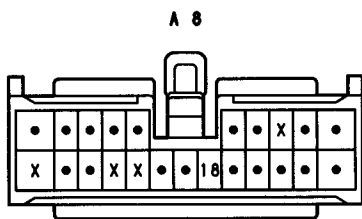

M 6 (A)



R 3 BLUE

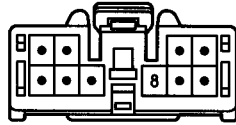

R13 BLUE



S15 BLUE

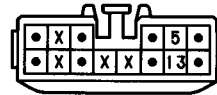

T15 (B)

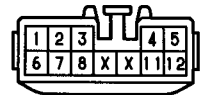

T16 (A)

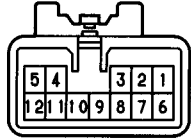

# CRUISE CONTROL

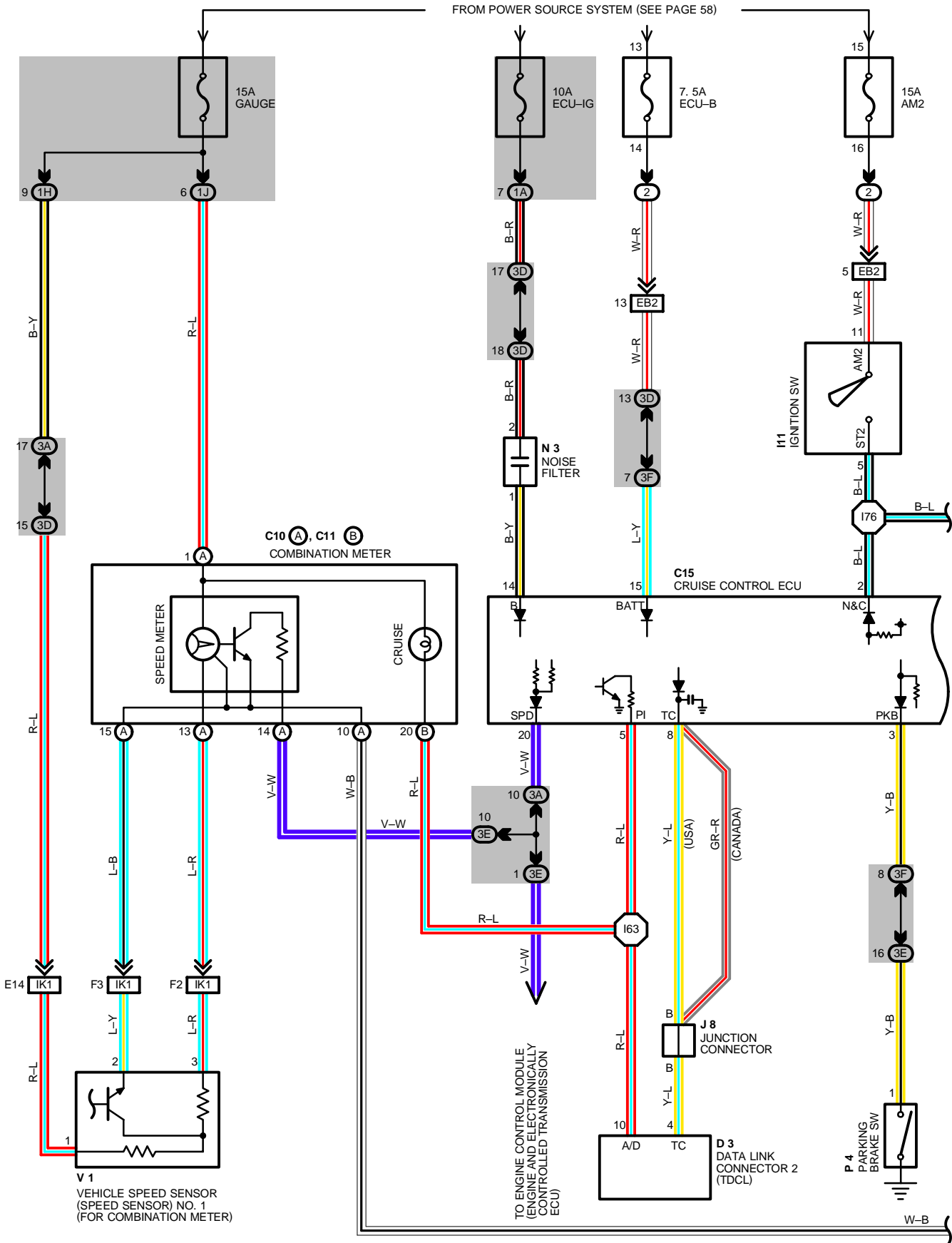



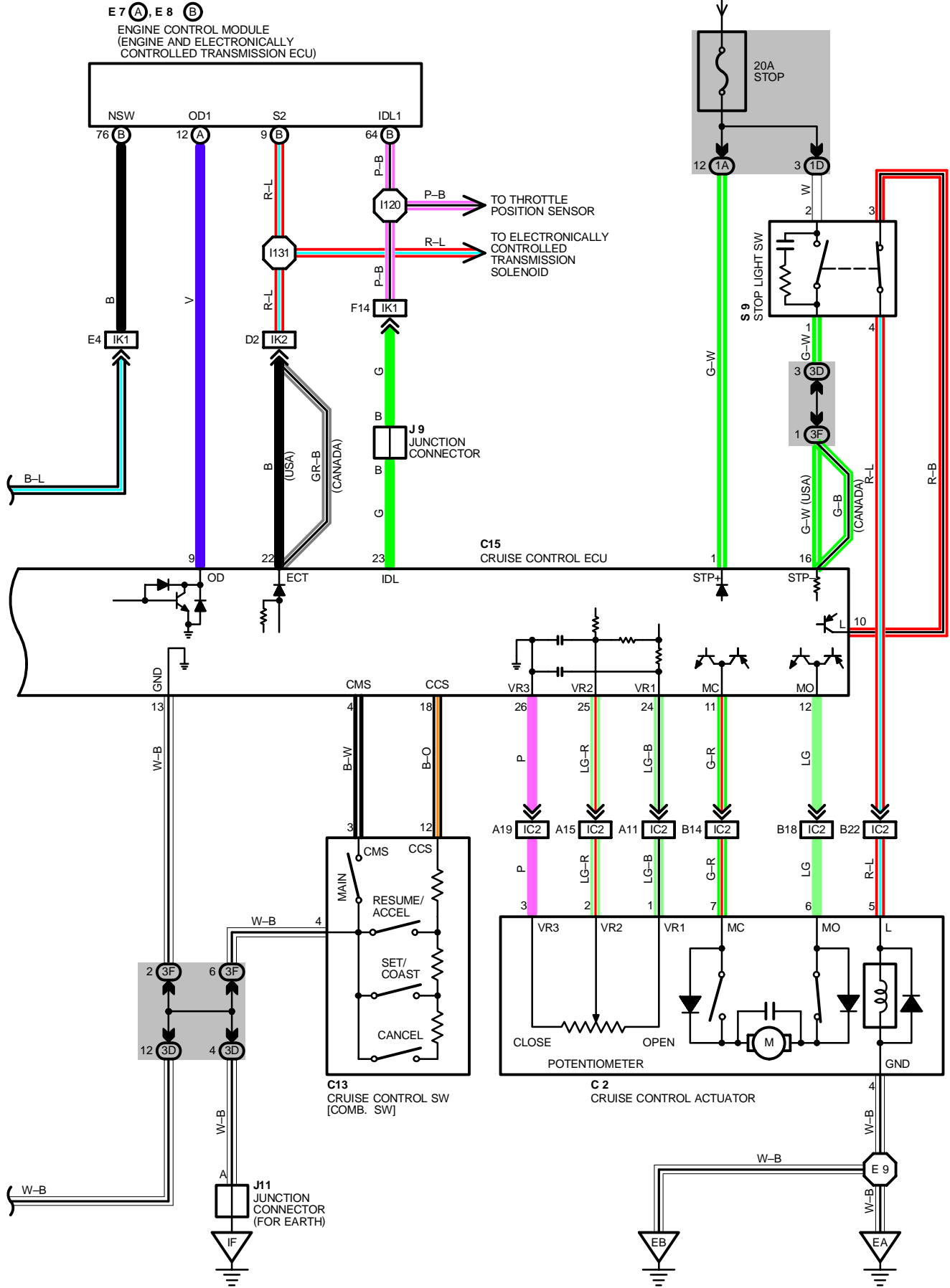

# CRUISE CONTROL

## SYSTEM OUTLINE

CURRENT IS APPLIED AT ALL TIMES THROUGH **STOP** FUSE TO **TERMINAL 1** OF THE CONTROL ECU AND **TERMINAL 2** OF STOP LIGHT SW, AND ALSO THROUGH THE **ECU-B** FUSE TO **TERMINAL 15** OF CRUISE CONTROL ECU.

WITH THE IGNITION SW TURNED TO ON, THE CURRENT FLOWS THROUGH GAUGE FUSE TO **TERMINAL (A)1** OF COMBINATION METER AND THE CURRENT THROUGH **ECU-IG** FUSE FLOWS TO **TERMINAL 14** OF CRUISE CONTROL ECU.

WHEN THE IGNITION SW IS ON AND THE CRUISE CONTROL MAIN SWITCH IS TURNED ON, A SIGNAL IS INPUT FROM **TERMINAL 3** OF CRUISE CONTROL MAIN SW TO **TERMINAL 4** OF CRUISE CONTROL ECU. AS A RESULT, THE CRUISE CONTROL ECU FUNCTIONS AND THE CURRENT TO **TERMINAL 14** OF CRUISE CONTROL ECU TO **TERMINAL 13** OF CRUISE CONTROL ECU → **GROUND**, AND THE CRUISE CONTROL SYSTEM IS IN A CONDITION READY FOR OPERATION.

AT THE SAME TIME, THE CURRENT THROUGH THE **GAUGE** FUSE FLOWS FROM **TERMINAL (A)1** OF CRUISE CONTROL INDICATOR LIGHT → **TERMINAL (B)20** → **TERMINAL 5** OF CRUISE CONTROL ECU → **TERMINAL 13** → TO **GROUND**, CAUSING THE CRUISE CONTROL INDICATOR LIGHT TO LIGHT UP, INDICATING THAT THE CRUISE CONTROL IS READY FOR OPERATION.

### 1. SET OPERATION

WHEN THE CRUISE CONTROL MAIN SW IS TURNED ON AND THE SET SW IS PUSHED WITH THE VEHICLE SPEED WITHIN THE SET LIMIT (APPROX. **40** KM/H, **25** MPH TO **200** KM/H, **124** MPH), A SIGNAL IS INPUT TO **TERMINAL 18** OF THE CRUISE CONTROL ECU AND THE VEHICLE SPEED AT THE TIME THE SET SW IS RELEASED IS MEMORIZED IN THE ECU AS THE SET SPEED.

### 2. SET SPEED CONTROL

DURING CRUISE CONTROL DRIVING, THE ECU COMPARES THE SET SPEED MEMORIZED IN THE ECU WITH THE ACTUAL VEHICLE SPEED INPUT INTO **TERMINAL 20** OF THE CRUISE CONTROL ECU FROM THE SPEED SENSOR, AND CONTROLS THE CRUISE CONTROL ACTUATOR TO MAINTAIN THE SET SPEED.

WHEN THE ACTUAL SPEED IS LOWER THAN THE SET SPEED, THE ECU CAUSES THE CURRENT TO THE CRUISE CONTROL ACTUATOR TO FLOW FROM **TERMINAL 12** → **TERMINAL 6** OF CRUISE CONTROL ACTUATOR → **TERMINAL 7** → **TERMINAL 11** OF CRUISE CONTROL ECU. AS A RESULT, THE MOTOR IN THE CRUISE CONTROL ACTUATOR IS ROTATED TO OPEN THE THROTTLE VALVE AND THE THROTTLE CABLE IS PULLED TO INCREASE THE VEHICLE SPEED. WHEN THE ACTUAL DRIVING SPEED IS HIGHER THAN THE SET SPEED, THE CURRENT TO CRUISE CONTROL ACTUATOR FLOWS FROM **TERMINAL 11** OF ECU → **TERMINAL 7** OF CRUISE CONTROL ACTUATOR → **TERMINAL 6** → **TERMINAL 12** OF CRUISE CONTROL ECU.

THIS CAUSES THE MOTOR IN THE CRUISE CONTROL ACTUATOR TO ROTATE TO CLOSE THE THROTTLE VALVE AND RETURN THE THROTTLE CABLE TO DECREASE THE VEHICLE SPEED.

### 3. COAST CONTROL

DURING THE CRUISE CONTROL DRIVING, WHILE THE COAST SW IS ON, THE CRUISE CONTROL ACTUATOR RETURNS THE THROTTLE CABLE TO CLOSE THE THROTTLE VALVE AND DECREASE THE DRIVING SPEED. THE VEHICLE SPEED WHEN THE COAST SWITCH IS TURNED OFF IS MEMORIZED AND THE VEHICLE CONTINUES AT THE NEW SET SPEED.

### 4. ACCEL CONTROL

DURING CRUISE CONTROL DRIVING, WHILE THE ACCEL SW IS TURNED ON, THE CRUISE CONTROL ACTUATOR PULLS THE THROTTLE CABLE TO OPEN THE THROTTLE VALVE AND INCREASE THE DRIVING SPEED.

THE VEHICLE SPEED WHEN THE ACCEL SW IS TURNED OFF IS MEMORIZED AND THE VEHICLE CONTINUES AT THE NEW SET SPEED.

### 5. RESUME CONTROL

UNLESS THE VEHICLE SPEED FALLS BELOW THE MINIMUM SPEED LIMIT (APPROX. **40** KM/H, **25** MPH) AFTER CANCELING THE SET SPEED BY THE CANCEL SW. PUSHING THE RESUME SW WILL CAUSE THE VEHICLE TO RESUME THE SPEED SET BEFORE CANCELLATION.

### 6. MANUAL CANCEL MECHANISM

IF ANY OF THE FOLLOWING OPERATIONS OCCURS DURING CRUISE CONTROL OPERATION, THE SAFETY MAGNETIC CLUTCH OF THE ACTUATOR TURNS OFF AND THE MOTOR ROTATES TO CLOSE THE THROTTLE VALVE AND THE CRUISE CONTROL IS RELEASED.

- \* PLACING THE SHIFT LEVER IN "N" POSITION (PARK/NEUTRAL POSITION SW(NEUTRAL START SW ON)). "SIGNAL INPUT TO **TERMINAL 2** OF THE ECU"
- \* DEPRESSING THE BRAKE PEDAL (STOP LIGHT SW ON). "SIGNAL INPUT TO **TERMINAL 16** OF THE ECU"
- \* PULLING THE PARKING BRAKE LEVER (PARKING BRAKE SW ON). "SIGNAL INPUT TO **TERMINAL 3** OF THE ECU"
- \* PUSHING THE CANCEL SWITCH (CANCEL SW ON). "SIGNAL INPUT TO **TERMINAL 18**" OF THE ECU"

## 7. AUTO CANCEL FUNCTION

A) IF ANY OF THE FOLLOWING OPERATING CONDITIONS OCCURS DURING CRUISE CONTROL OPERATION, THE SET SPEED IS ERASED. CURRENT FLOW TO SAFETY MAGNETIC CLUTCH IS STOPPED AND THE CRUISE CONTROL IS RELEASED. (MAIN SW TURNS OFF).

WHEN THIS OCCURS, THE IGNITION SW MUST BE TURNED OFF ONCE BEFORE THE MAIN SW WILL TURN ON.

- \* OVER CURRENT TO TRANSISTOR DRIVING MOTOR AND/OR SAFETY MAGNETIC CLUTCH.
- \* WHEN CURRENT CONTINUED TO FLOW TO THE MOTOR INSIDE THE ACTUATOR IN THE THROTTLE VALVE "OPEN" DIRECTION.
- \* OPEN CIRCUIT IN SAFETY MAGNETIC CLUTCH.
- \* MOMENTARY INTERRUPTION OF VEHICLE SPEED SIGNAL.
- \* SHORT CIRCUIT IN CRUISE CONTROL SW.
- \* MOTOR DOES NOT OPERATE DESPITE THE MOTOR DRIVE SIGNAL BEING OUTPUT.

B) IF ANY OF THE FOLLOWING CONDITIONS OCCURS DURING CRUISE CONTROL OPERATION, THE SET SPEED IS ERASED AND THE CRUISE CONTROL IS RELEASED. (THE POWER OF SAFETY MAGNETIC CLUTCH IS CUT OFF UNTIL THE SET SW IS "ON" AGAIN.)

- \* WHEN THE VEHICLE SPEED FALLS BELOW THE MINIMUM SPEED LIMIT, APPROX. **40 KM/H (25 MPH)**
- \* WHEN THE VEHICLE SPEED FALLS MORE THAN **16 KM/H (10 MPH)** BELOW THE SET SPEED, E.G. ON AN UPWARD SLOPE.
- \* WHEN POWER TO THE CRUISE CONTROL SYSTEM IS MOMENTARILY CUT OFF.

C) IF ANY OF THE FOLLOWING CONDITIONS OCCURS DURING CRUISE CONTROL OPERATION, THE CRUISE CONTROL IS RELEASED.

- \* OPEN CIRCUIT FOR **TERMINAL 1** OF THE CRUISE CONTROL ECU AND **TERMINAL 2** OF STOP LIGHT SW.

## 8. AUTOMATIC TRANSMISSION CONTROL FUNCTION

\* IN OVERDRIVE. IF THE VEHICLE SPEED BECOMES LOWER THAN THE OVERDRIVE CUT SPEED (SET SPEED MINUS APPROX. **4 KM/H, 2.5 MPH**) DURING CRUISE CONTROL OPERATION, SUCH AS DRIVING UP A HILL, THE OVERDRIVE IS RELEASED AND THE POWER INCREASED TO PREVENT A REDUCTION IN VEHICLE SPEED.

\* AFTER RELEASING THE OVERDRIVE, VEHICLE SPEED BECOMES HIGHER THAN THE OVERDRIVE RETURN SPEED (SET SPEED MINUS APPROX. **2 KM/H, 1.2 MPH**) AND THE ECU JUDGES BY THE SIGNALS FROM POTENTIOMETER OF THE ACTUATOR THAT THE UPWARD SLOPE HAS FINISHED, OVERDRIVE IS RESUMED AFTER APPROXIMATELY **6 SECONDS**.

\* DURING CRUISE CONTROL DRIVING, THE CRUISE CONTROL OPERATION SIGNAL IS OUTPUT FROM THE CRUISE CONTROL ECU TO THE ENGINE CONTROL MODULE (ENGINE AND ELECTRONICALLY CONTROLLED TRANSMISSION ECU). UPON RECEIVING THIS SIGNAL, THE ENGINE CONTROL MODULE (ENGINE AND ELECTRONICALLY CONTROLLED TRANSMISSION ECU) CHANGES THE SHIFT PATTERN TO NORMAL.

TO MAINTAIN SMOOTH CRUISE CONTROL OPERATION (ON A DOWNWARD SLOPE ETC.), LOCK-UP RELEASE OF THE TRANSMISSION WHEN THE IDLING POINT OF THE THROTTLE POSITION IS "ON" IS FORBIDDEN.

## SERVICE HINTS

### C2 CRUISE CONTROL ACTUATOR

- 1-3 : APPROX. **2 K $\Omega$**
- 5-4 : APPROX. **38.5**

### C13 CRUISE CONTROL SW [COMB. SW]

- 3-4 : CONTINUITY WITH MAIN SW ON
- 12-4 : APPROX. **418** WITH CANCEL SW ON  
APPROX. **68** WITH RESUME/ACCEL SW ON  
APPROX. **198** WITH SET/COAST SW ON

### C15 CRUISE CONTROL ECU

- 14-GROUND : APPROX. **12 VOLTS** WITH IGNITION SW AT **ON** POSITION
- 1, 15-GROUND : ALWAYS APPROX. **12 VOLTS**
- 3-GROUND : CONTINUITY WITH PARKING BRAKE PEDAL DEPRESSED (ONE OF THE CANCEL SW)
- 20-GROUND : **4 PULSE** WITH **1 ROTATION** OF ROTOR SHAFT
- 18-GROUND : APPROX. **418** WITH CANCEL SW ON IN CONTROL SW  
APPROX. **198** WITH SET/COAST SW ON IN CONTROL SW  
APPROX. **68** WITH RESUME/ACCEL SW ON IN CRUISE CONTROL SW
- 13-GROUND : ALWAYS CONTINUITY

# CRUISE CONTROL

## ○ : PARTS LOCATION

CODE	SEE PAGE	CODE	SEE PAGE	CODE	SEE PAGE
C 2	26	E 7	A 28	N 3	29
C10	A 28	E 8	B 28	P 4	29
C11	B 28	I11	29	S 9	29
C13	28	J 8	29	V 1	27
C15	28	J 9	29		
D 3	28	J11	29		

## ○ : RELAY BLOCKS

CODE	SEE PAGE	RELAY BLOCKS (RELAY BLOCK LOCATION)
2	19	R/B NO. 2 (ENGINE COMPARTMENT LEFT)

## ○ : JUNCTION BLOCK AND WIRE HARNESS CONNECTOR

CODE	SEE PAGE	JUNCTION BLOCK AND WIRE HARNESS (CONNECTOR LOCATION)
1A	20	COWL WIRE AND J/B NO. 1 (LEFT KICK PANEL)
1D		
1H		
1J		
3A	22	COWL WIRE AND J/B NO. 3 (BEHIND THE INSTRUMENT PANEL CENTER)
3C		
3E		
3F		

## □ : CONNECTOR JOINING WIRE HARNESS AND WIRE HARNESS

CODE	SEE PAGE	JOINING WIRE HARNESS AND WIRE HARNESS (CONNECTOR LOCATION)
EB2	34	COWL WIRE AND R/B NO. 2 WIRE (INSIDE OF R/B NO. 2)
IC2	36	ENGINE ROOM MAIN WIRE AND COWL WIRE (UNDER THE GLOVE BOX)
IK1	38	ENGINE WIRE AND COWL WIRE (UNDER THE GLOVE BOX)
IK2		

## ▽ : GROUND POINTS

CODE	SEE PAGE	GROUND POINTS LOCATION
EA	34	FRONT SIDE OF RIGHT FENDER
EB	34	FRONT SIDE OF LEFT FENDER
IF	36	BEHIND COMPARTMENT METER

## ○ : SPLICE POINTS

CODE	SEE PAGE	WIRE HARNESS WITH SPLICE POINTS	CODE	SEE PAGE	WIRE HARNESS WITH SPLICE POINTS
E 9	34	ENGINE ROOM MAIN WIRE	I120	38	ENGINE WIRE
I63	38	COWL WIRE	I131		
I76					

C 2 GRAY

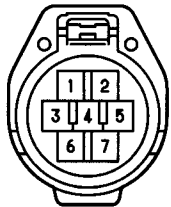

C10 (A) ORANGE

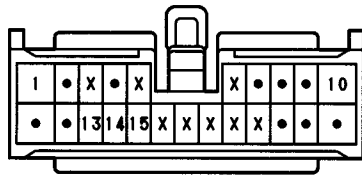

C11 (B) GRAY

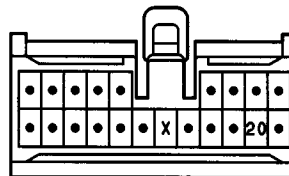

C13

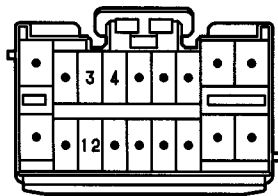

C15 GRAY

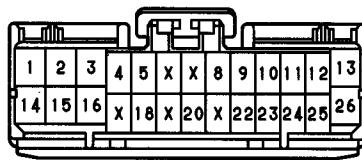

D 3

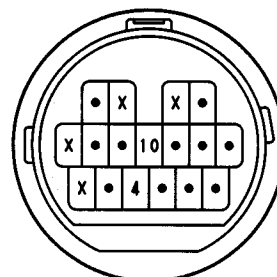

E 7 **A** DARK GRAY

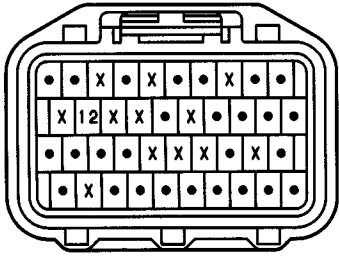

E 8 **B** DARK GRAY

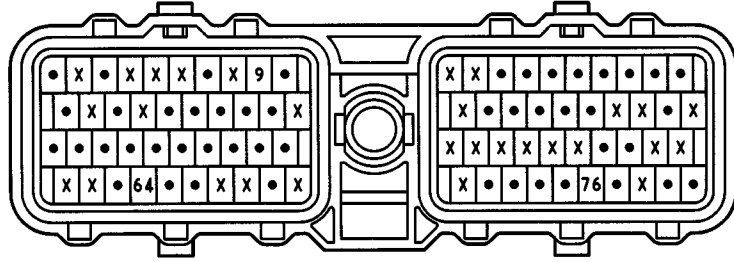

I11 BLACK

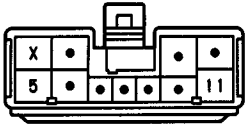

J 8

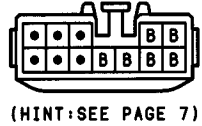

(HINT:SEE PAGE 7)

J 9 GRAY



(HINT:SEE PAGE 7)

J11

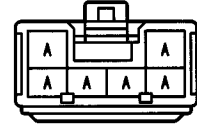

(HINT:SEE PAGE 7)

N 3

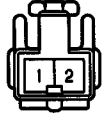

P 4 GRAY



S 9

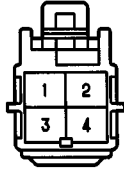

V 1 BLACK



# ABS (ANTI-LOCK BRAKE SYSTEM)

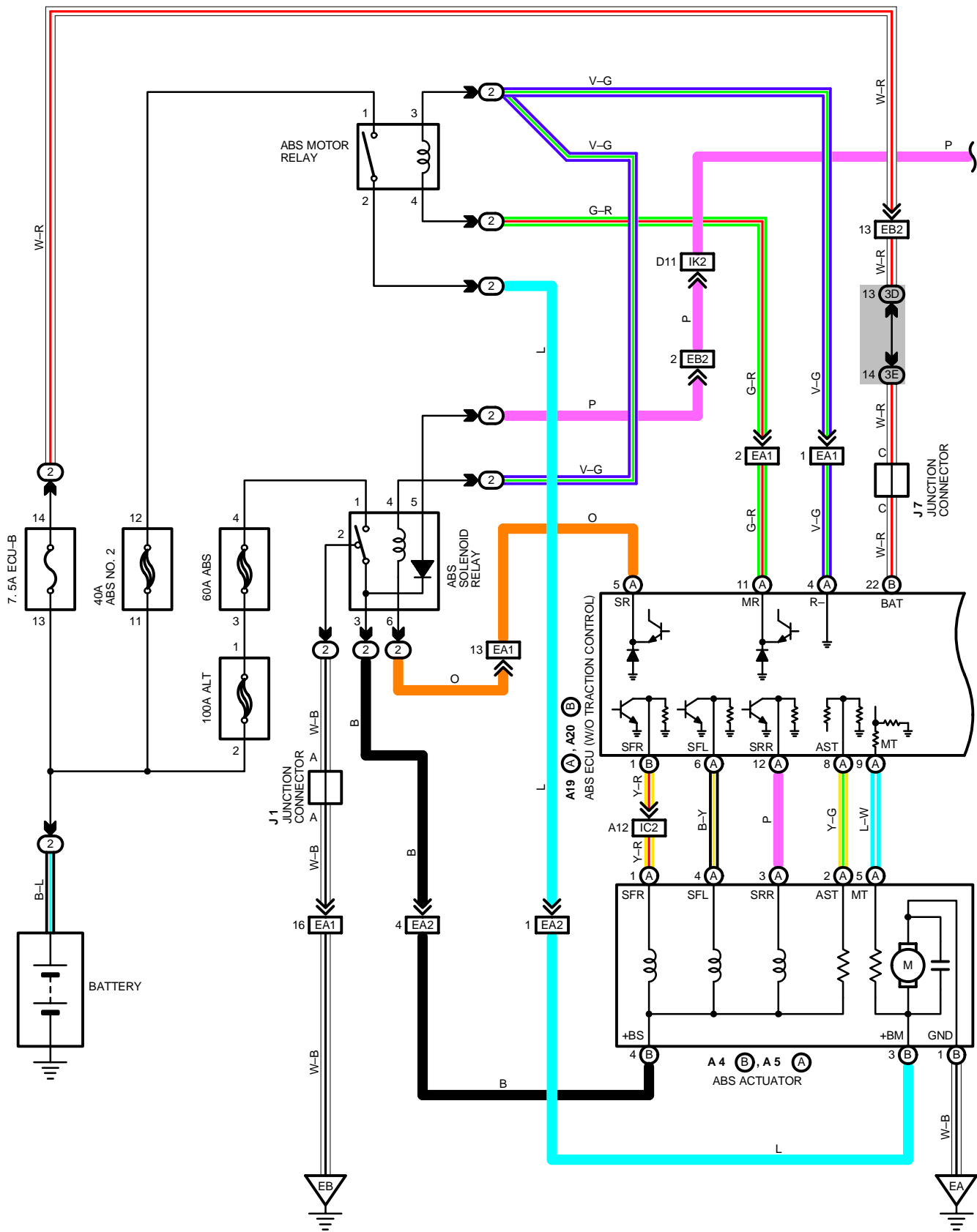

FROM POWER SOURCE SYSTEM (SEE PAGE 58)

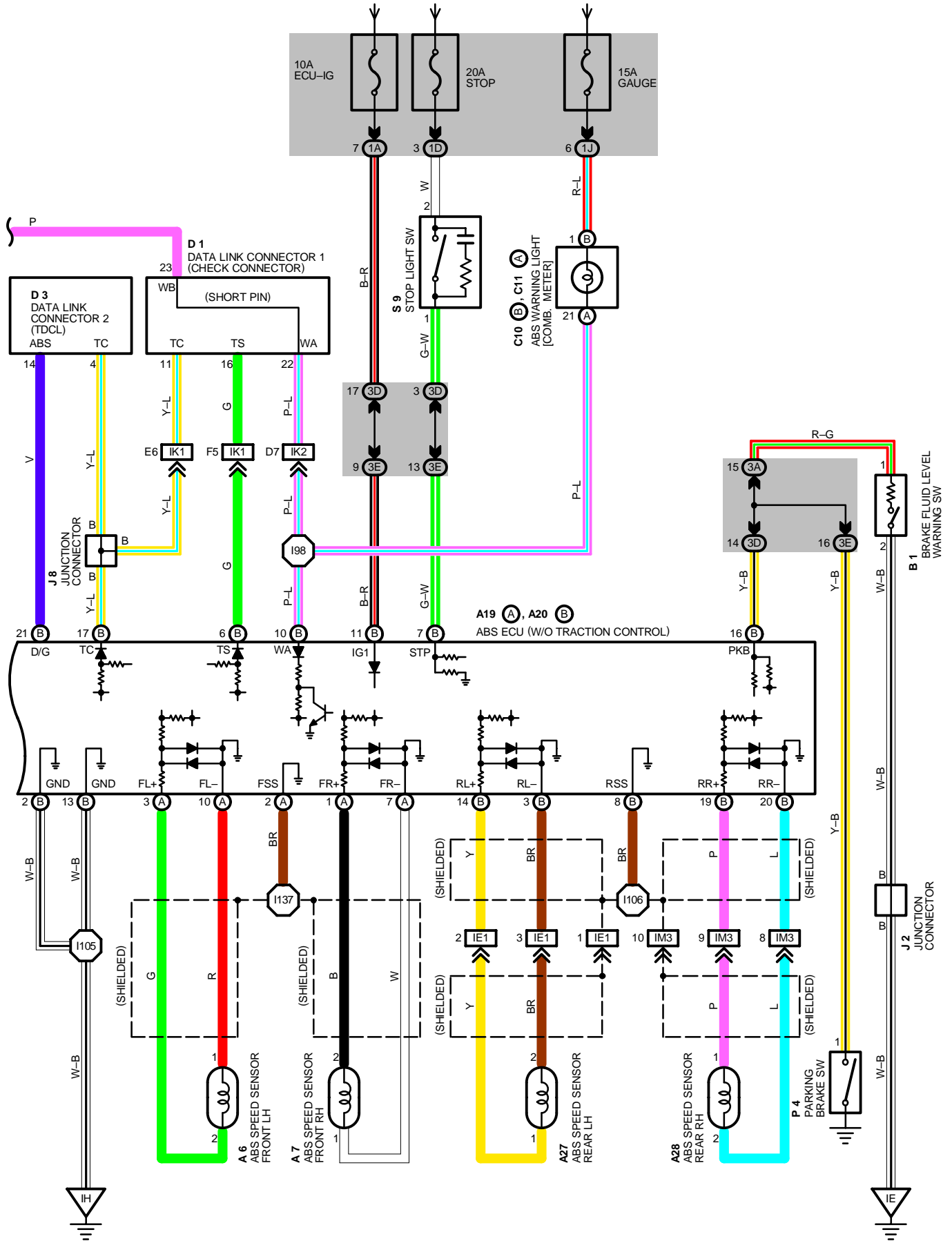

# ABS (ANTI-LOCK BRAKE SYSTEM)

## SYSTEM OUTLINE

THIS SYSTEM CONTROLS THE RESPECTIVE BRAKE FLUID PRESSURES ACTING ON THE DISC BRAKE CYLINDERS OF THE RIGHT FRONT WHEEL, LEFT FRONT WHEEL AND REAR WHEELS WHEN THE BRAKES ARE APPLIED IN A PANIC STOP SO THAT THE WHEELS DO NOT LOCK.

THIS RESULTS IN IMPROVED DIRECTIONAL STABILITY AND STEERABILITY DURING PANIC BRAKING.

### 1. INPUT SIGNALS

#### (1) SPEED SENSOR SIGNAL

THE SPEED OF THE WHEELS IS DETECTED AND INPUT TO **TERMINALS FL+, FR+, RL+ AND RR+** OF THE ABS ECU.

#### (2) STOP LIGHT SW SIGNAL

A SIGNAL IS INPUT TO **TERMINAL STP** OF THE ABS ECU WHEN THE BRAKE PEDAL IS OPERATED.

#### (3) PARKING BRAKE SW SIGNAL

A SIGNAL IS INPUT TO **TERMINAL PKB** OF THE ABS ECU WHEN THE PARKING BRAKE IS OPERATED.

### 2. SYSTEM OPERATION

DURING SUDDEN BRAKING, THE ABS ECU WHICH HAS SIGNALS INPUT FROM EACH SENSOR CONTROLS THE CURRENT FLOWING TO THE SOLENOID INSIDE THE ACTUATOR AND LETS THE HYDRAULIC PRESSURE ACTING ON EACH WHEEL CYLINDER ESCAPE TO THE RESERVOIR.

THE PUMP INSIDE THE ACTUATOR IS ALSO OPERATING AT THIS TIME AND IT RETURNS THE BRAKE FLUID FROM THE RESERVOIR TO THE MASTER CYLINDER, THUS PREVENTING LOCKING OF THE VEHICLE WHEELS.

IF THE ECU JUDGES THAT THE HYDRAULIC PRESSURE ACTING ON THE WHEEL CYLINDER IS INSUFFICIENT, THE CURRENT ACTING ON SOLENOID IS CONTROLLED AND THE HYDRAULIC PRESSURE IS INCREASED.

HOLDING OF THE HYDRAULIC PRESSURE IS ALSO CONTROLLED BY THE ECU, BY THE SAME METHOD AS ABOVE, BY REPEATED PRESSURE REDUCTION, HOLDING AND INCREASE ARE REPEATED TO MAINTAIN VEHICLE STABILITY AND TO IMPROVE STEERABILITY DURING SUDDEN BRAKING.

## SERVICE HINTS

### A 4(B), A 5(A) ABS ACTUATOR

(B) 1-GROUND : ALWAYS CONTINUITY

(A) 1, (A) 3, (B) 4-GROUND : APPROX. 1.20 (IGNITION SW OFF)

(A) 2-GROUND : 4-6 (IGNITION SW OFF)

### A 6, A 7, A27, A28 ABS SPEED SENSOR FRONT LH, RH, REAR LH, RH

1-2 : 0.8-1.3 K (20°C, 68°F)

### A19(A), A20(B) ABS ECU (W/O TRACTION CONTROL)

(B) 11-GROUND : 10-14 VOLTS WITH IGNITION SW ON

(B) 2, (B) 13-GROUND : ALWAYS CONTINUITY

(B) 22-GROUND : ALWAYS 10-14 VOLTS

(B) 1, (A) 6, (A) 12-GROUND : 10-14 VOLTS WITH IGNITION SW AT ON

(B) 16-GROUND : CONTINUITY WITH PARKING BRAKE PEDAL DEPRESSED

(B) 7-GROUND : 10-14 VOLTS WITH STOP LIGHT SW ON (BRAKE PEDAL DEPRESSED)

### P 4 PARKING BRAKE SW

1-GROUND : CLOSED WITH PARKING BRAKE PEDAL DEPRESSED

### S 9 STOP LIGHT SW

1-2 : CLOSED WITH BRAKE PEDAL DEPRESSED



 : PARTS LOCATION

CODE		SEE PAGE	CODE		SEE PAGE	CODE	SEE PAGE
A 4	B	26	A28		30	J 2	29
A 5	A	26	B 1		26	J 7	29
A 6		26	C10	B	28	J 8	29
A 7		26	C11	A	28	P 4	29
A19	A	28	D 1		26	S 9	29
A20	B	28	D 3		28		
A27		30	J 1		27		

 : RELAY BLOCKS

CODE	SEE PAGE	RELAY BLOCKS (RELAY BLOCK LOCATION)
2	19	R/B NO. 2 (ENGINE COMPARTMENT LEFT)

 : JUNCTION BLOCK AND WIRE HARNESS CONNECTOR

CODE	SEE PAGE	JUNCTION BLOCK AND WIRE HARNESS (CONNECTOR LOCATION)
1A	20	COWL WIRE AND J/B NO. 1 (LEFT KICK PANEL)
1D		
1J		
3A	22	COWL WIRE AND J/B NO. 3 (BEHIND THE INSTRUMENT PANEL CENTER)
3D		
3E		

 : CONNECTOR JOINING WIRE HARNESS AND WIRE HARNESS

CODE	SEE PAGE	JOINING WIRE HARNESS AND WIRE HARNESS (CONNECTOR LOCATION)
EA1	34	ENGINE ROOM MAIN WIRE AND R/B NO. 2 WIRE (INSIDE OF R/B NO. 2)
EA2		
EB2	34	COWL WIRE AND R/B NO. 2 WIRE (INSIDE OF R/B NO. 2)
IC2	36	ENGINE ROOM MAIN WIRE AND COWL WIRE (UNDER THE GLOVE BOX)
IE1	36	COWL WIRE AND FLOOR NO. 2 WIRE (LEFT KICK PANEL)
IK1	38	ENGINE WIRE AND COWL WIRE (UNDER THE GLOVE BOX)
IK2		
IM3	38	COWL WIRE AND FLOOR NO. 1 WIRE (RIGHT KICK PANEL)

 : GROUND POINTS

CODE	SEE PAGE	GROUND POINTS LOCATION
EA	34	FRONT SIDE OF RIGHT FENDER
EB	34	FRONT SIDE OF LEFT FENDER
IE	36	LEFT KICK PANEL
IH	36	RIGHT KICK PANEL

 : SPLICE POINTS

CODE	SEE PAGE	WIRE HARNESS WITH SPLICE POINTS	CODE	SEE PAGE	WIRE HARNESS WITH SPLICE POINTS
I98	38	COWL WIRE	I106	38	COWL WIRE
I105			I137	38	ENGINE ROOM MAIN WIRE

# ABS (ANTI-LOCK BRAKE SYSTEM)

A 4 (B) BLACK



A 5 (A) GRAY



A 6, A 7 GRAY



A19 (A) GRAY

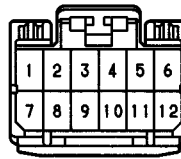

A20 (B) GRAY

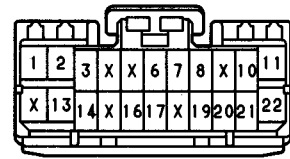

A27, A28 GRAY

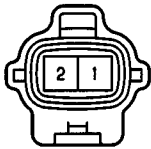

B 1 GRAY



C10 (B) ORANGE

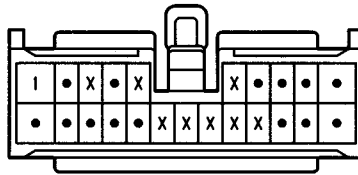

C11 (A) GRAY

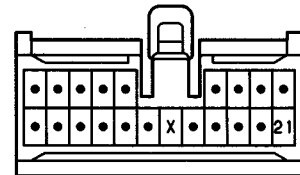

D 1 BLACK

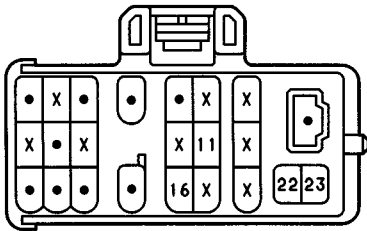

D 3

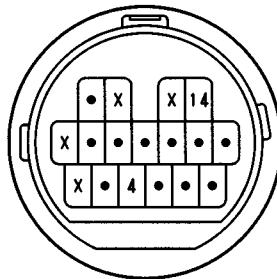

J 1



(HINT:SEE PAGE 7)

J 2

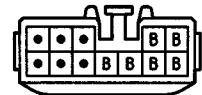

(HINT:SEE PAGE 7)

J 7 GRAY

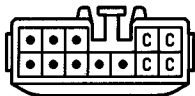

(HINT:SEE PAGE 7)

J 8

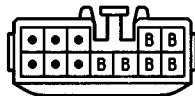

(HINT:SEE PAGE 7)

P 4 GRAY



S 9

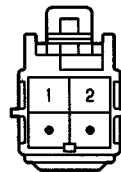

## SYSTEM OUTLINE

(FOR ABS)

THIS SYSTEM CONTROLS THE RESPECTIVE BRAKE FLUID PRESSURES ACTING ON THE DISC BRAKE CYLINDERS OF THE RIGHT FRONT WHEEL, LEFT FRONT WHEEL AND REAR WHEELS WHEN THE BRAKES ARE APPLIED IN A PANIC STOP SO THAT THE WHEELS DO NOT LOCK.

THIS RESULTS IN IMPROVED DIRECTIONALLY STABILITY AND STEERABILITY DURING PANIC BRAKING.

### 1. INPUT SIGNALS

#### (1) SPEED SENSOR SIGNAL

THE SPEED OF THE WHEELS IS DETECTED AND INPUT TO **TERMINALS FL+, FR+, RL+ AND RR+** OF THE ABS AND TRACTION ECU.

#### (2) STOP LIGHT SW SIGNAL

A SIGNAL IS INPUT TO **TERMINAL STP** OF THE ABS AND TRACTION ECU WHEN THE BRAKE PEDAL IS OPERATED.

#### (3) PARKING BRAKE SW SIGNAL

A SIGNAL IS INPUT TO **TERMINAL PKB** OF THE ABS AND TRACTION ECU WHEN THE PARKING BRAKE IS OPERATED.

### 2. SYSTEM OPERATION

DURING SUDDEN BRAKING, THE ABS AND TRACTION ECU WHICH HAS SIGNALS INPUT FROM EACH SENSOR CONTROLS THE CURRENT FLOWING TO THE SOLENOID INSIDE THE ACTUATOR AND LETS THE HYDRAULIC PRESSURE ACTING ON EACH WHEEL CYLINDER ESCAPE TO THE RESERVOIR. THE PUMP INSIDE THE ACTUATOR IS ALSO OPERATING AT THIS TIME AND IT RETURNS THE BRAKE FLUID FROM THE RESERVOIR TO THE MASTER CYLINDER, THUS PREVENTING LOCKING OF THE VEHICLE WHEELS.

IF THE ECU JUDGES THAT THE HYDRAULIC PRESSURE ACTING ON THE WHEEL CYLINDER IS INSUFFICIENT, THE CURRENT ACTING ON SOLENOID IS CONTROLLED AND THE HYDRAULIC PRESSURE IS INCREASED, HOLDING OF THE HYDRAULIC PRESSURE IS ALSO CONTROLLED BY THE ECU, BY THE SAME METHOD AS ABOVE. BY REPEATED PRESSURE REDUCTION, HOLDING AND INCREASE ARE REPEATED TO MAINTAIN VEHICLE STABILITY AND TO IMPROVE STEERABILITY DURING SUDDEN BRAKING.

(FOR TRACTION CONTROL)

THE TRACTION CONTROL SYSTEM IS A SYSTEM WHEREBY THE "ABS AND TRACTION ECU" AND "TRACTION ECU" CONTROLS THE ENGINE TORQUE AND THE HYDRAULIC PRESSURE OF THE WHEEL CYLINDER OF THE DRIVING WHEELS IN ORDER TO CONTROL SPINNING OF THE DRIVING WHEELS WHEN STARTING OFF AND ACCELERATING, AND PROVIDE THE MOST APPROPRIATE DRIVING FORCE IN RESPONSE TO THE ROAD CONDITIONS FOR VEHICLE STABILITY.

#### TRACTION CONTROL OPERATION

VEHICLE SPEED SIGNALS FROM THE SPEED SENSOR INSTALLED ON EACH WHEEL ARE INPUT TO THE ABS AND TRACTION ECU.

WHEN THE ACCELERATOR PEDAL IS DEPRESSED WHILE DRIVING ON A SLIPPERY ROAD AND THE DRIVING WHEEL (REAR WHEEL) SLIPS, IF THE ROTATION OF THE REAR WHEEL EXCEEDS THE ROTATION OF THE FRONT WHEELS FOR A SPECIFIED PERIOD, THE ECU JUDGES THAT THE REAR WHEEL IS SLIPPING.

WHEN THIS OCCURS, CURRENT FLOWS FROM TRACTION ECU TO SUB THROTTLE ACTUATOR TO CLOSE THE SUB THROTTLE VALVE.

THE THROTTLE VALVE OPENING ANGLE SIGNAL IS OUTPUT FROM **TERMINAL VTA** OF SUB THROTTLE POSITION SENSOR TO **TERMINAL VTA2** OF ENGINE CONTROL MODULE (ENGINE AND ELECTRONICALLY CONTROLLED TRANSMISSION ECU) TO KEEP THE ENGINE RPM AT THE MOST SUITABLE LEVEL FOR THE DRIVING CONDITIONS AND REDUCE SLIP OF THE DRIVING WHEEL. AT THE SAME TIME, OPERATION OF THE ABS AND TRACTION ECU CAUSE THE TRACTION BRAKE ACTUATORS (ACC CUT, MIC CUT, RESERVOIR CUT SOLENOID) TO TURN ON TO SWITCH THE HYDRAULIC CIRCUIT TO "TRACTION" MODE.

IN THIS CASE, SIGNALS ARE INPUT FROM **TERMINAL SRR** OF THE ABS AND TRACTION ECU TO **TERMINAL (A)3** OF THE ABS ACTUATOR, AND FROM **TERMINAL SRL** OF ABS AND TRACTION ECU TO **TERMINAL (A)6** OF ABS ACTUATOR, CONTROLLING THE REAR WHEEL SOLENOID IN THE ABS ACTUATOR AND INCREASING THE HYDRAULIC PRESSURE OF THE WHEEL CYLINDER IN ORDER TO PREVENT SLIP.

TO MAINTAIN THE HYDRAULIC PRESSURE OF THE REAR WHEELS, THE REAR WHEEL SOLENOID INSIDE THE ABS ACTUATOR IS PUT IN "HOLD" MODE AND KEEPS THE HYDRAULIC PRESSURE TO THE WHEEL CYLINDER CONSTANT.

WHEN THE BRAKE CYLINDER HYDRAULIC PRESSURE IS REDUCED, THE PRESSURE REDUCTION MODE REDUCES AND CONTROLS THE HYDRAULIC PRESSURE.

# ABS AND TRACTION CONTROL

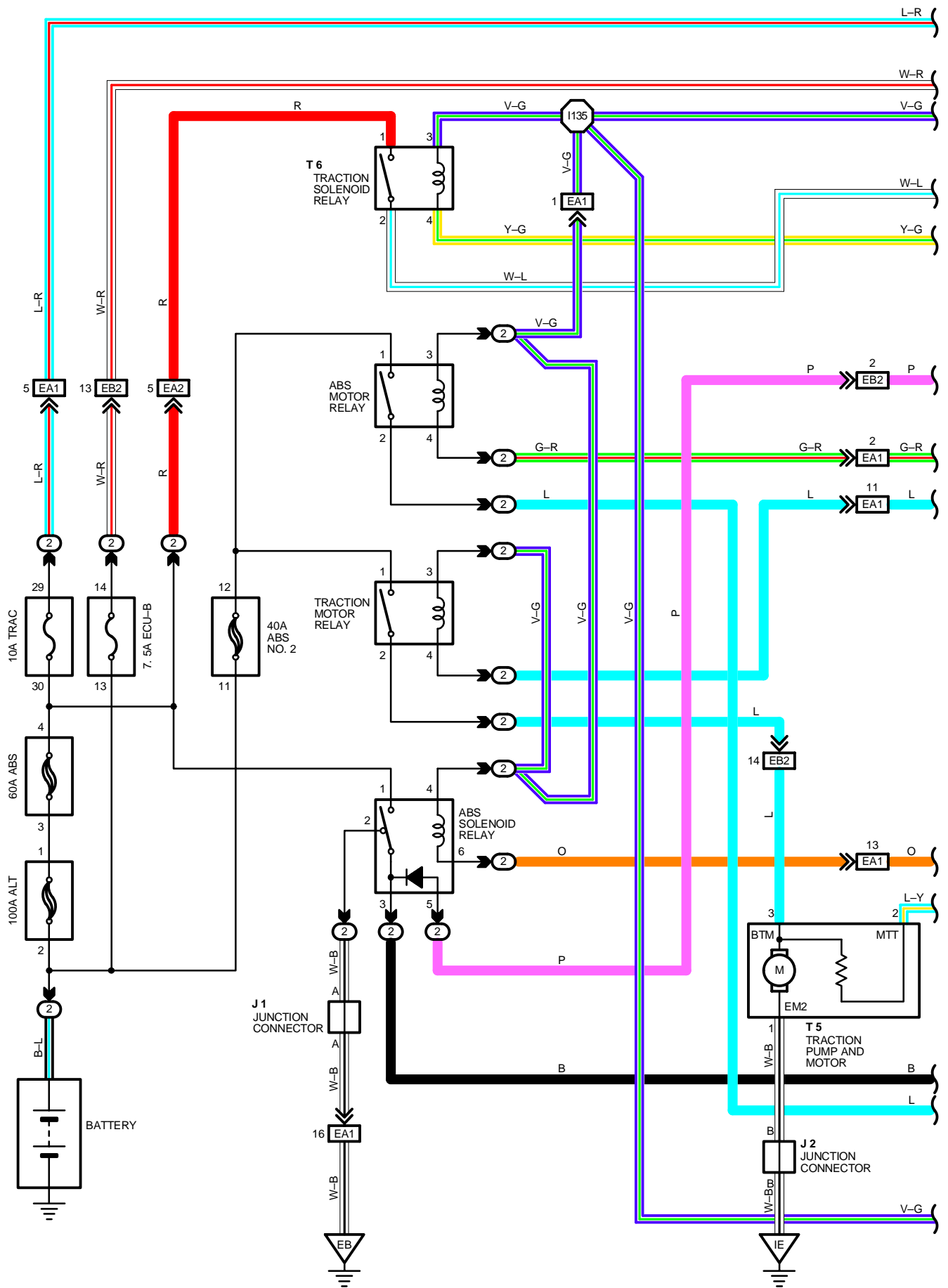

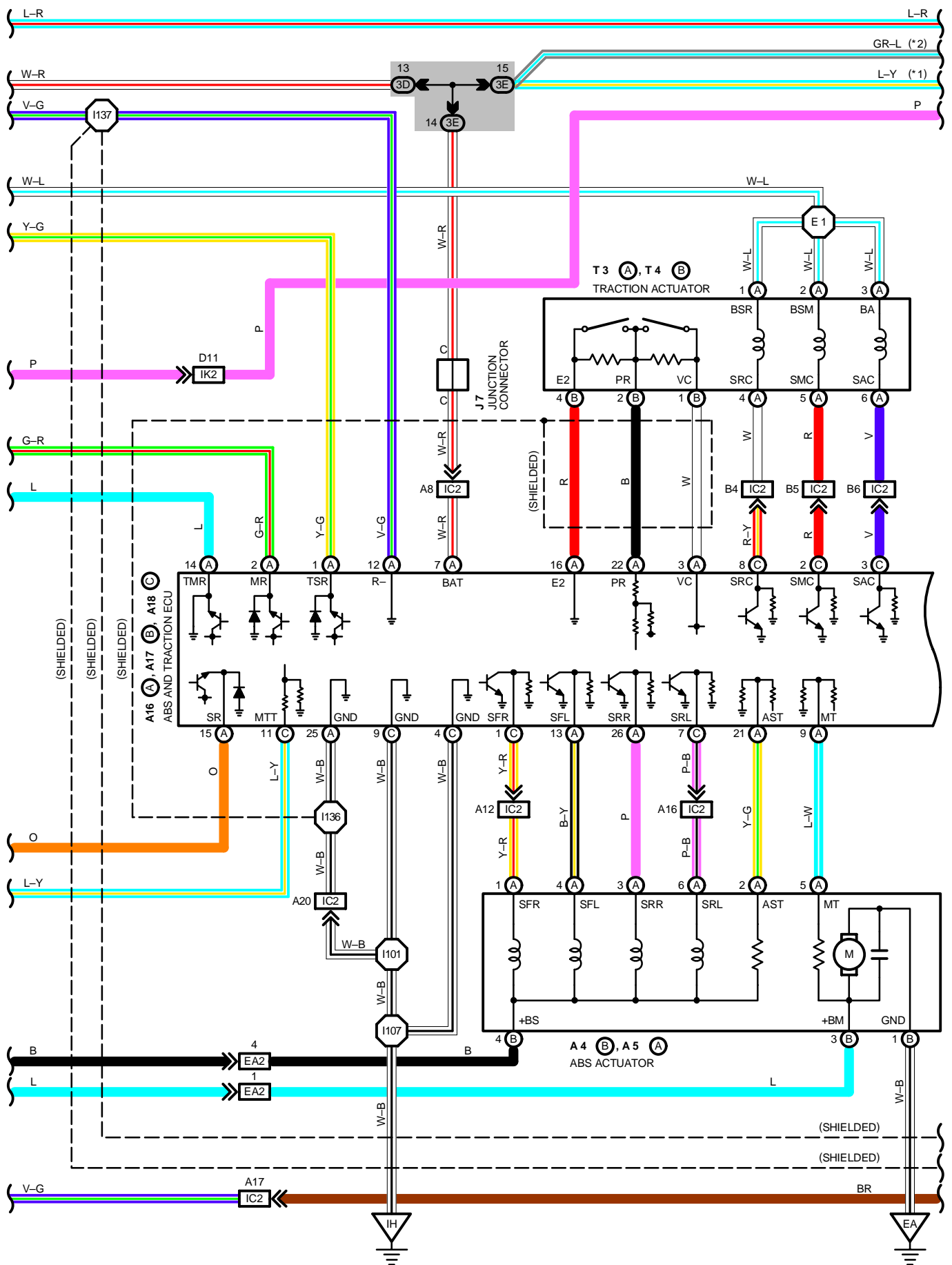

# ABS AND TRACTION CONTROL

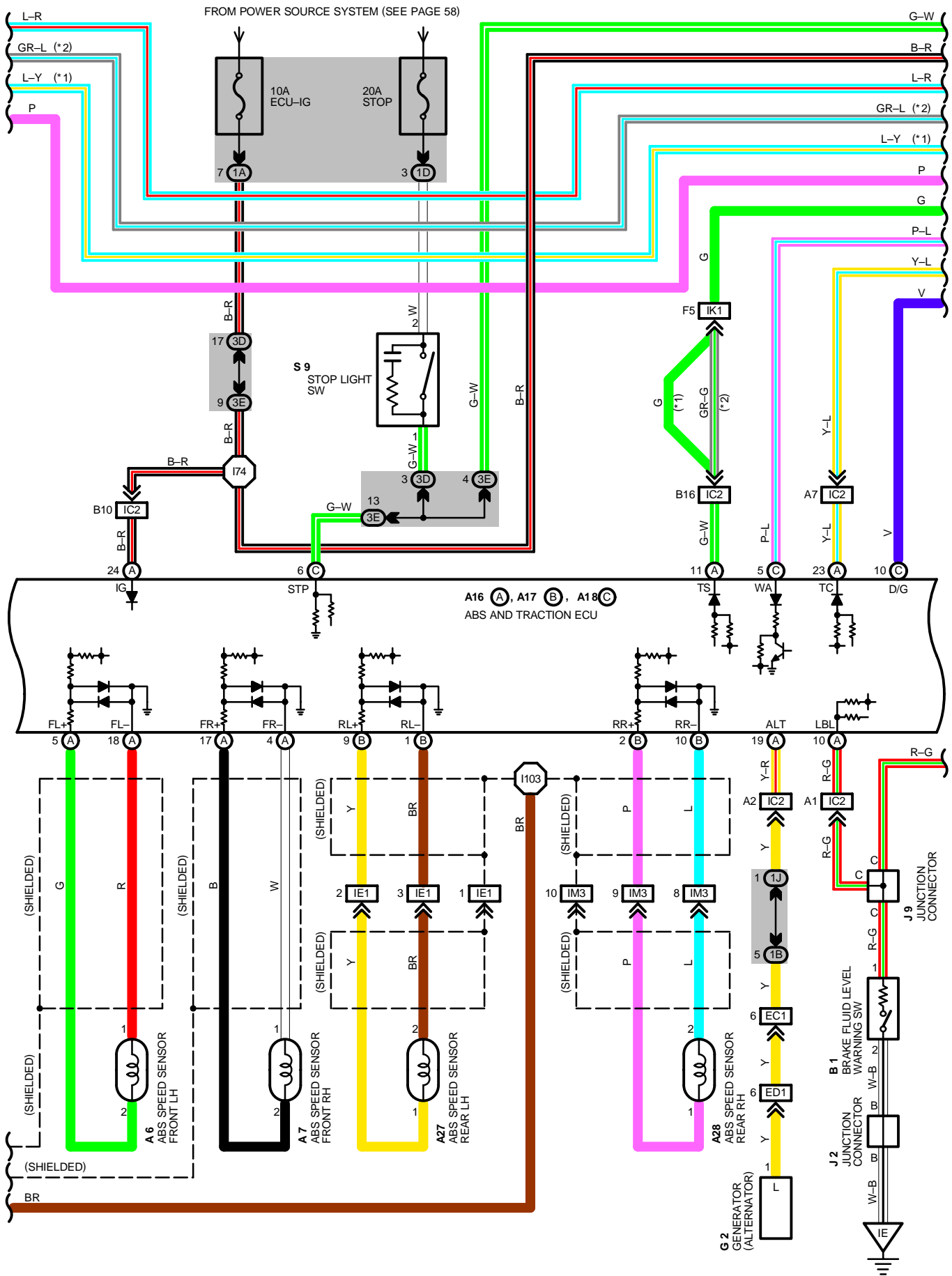

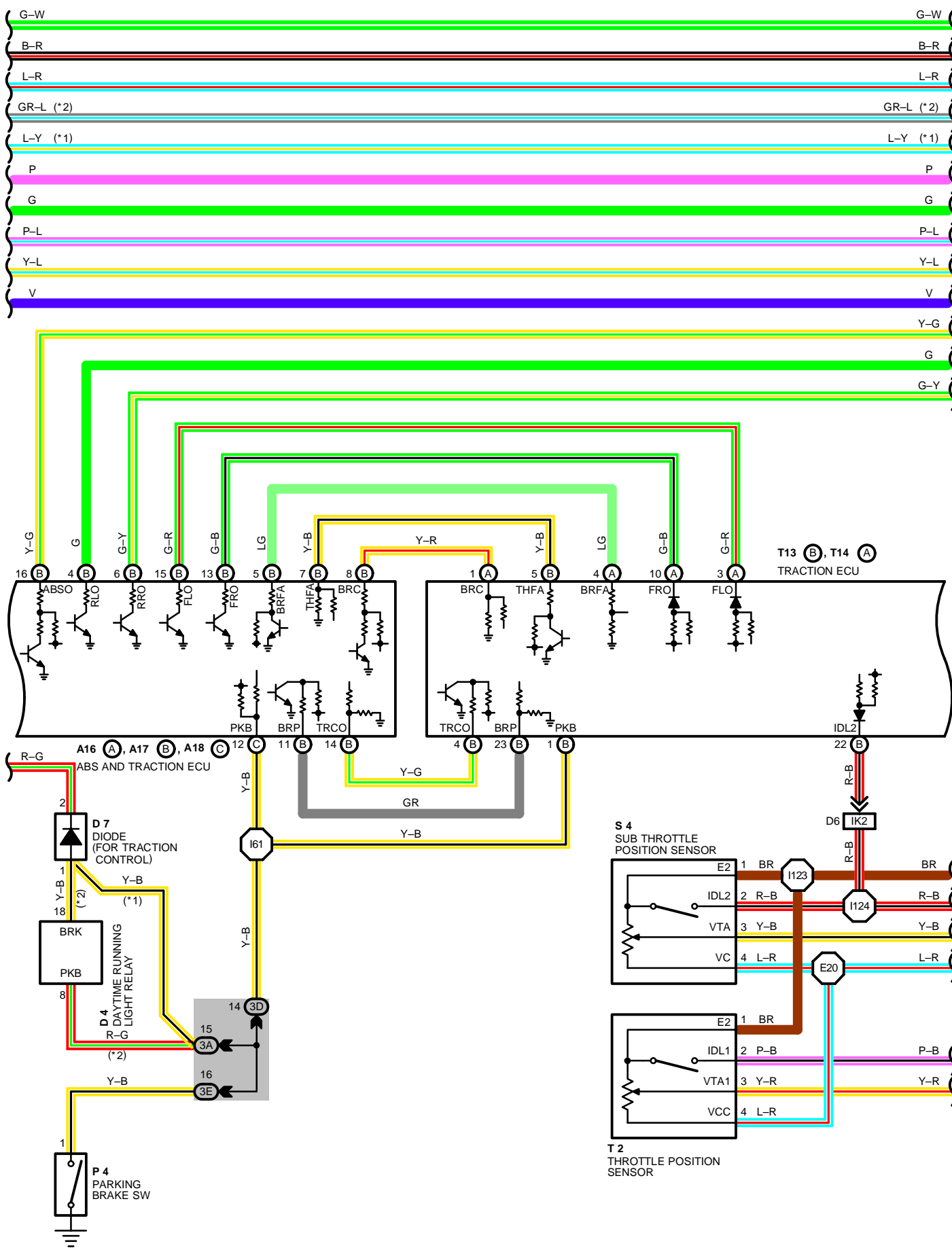

# ABS AND TRACTION CONTROL

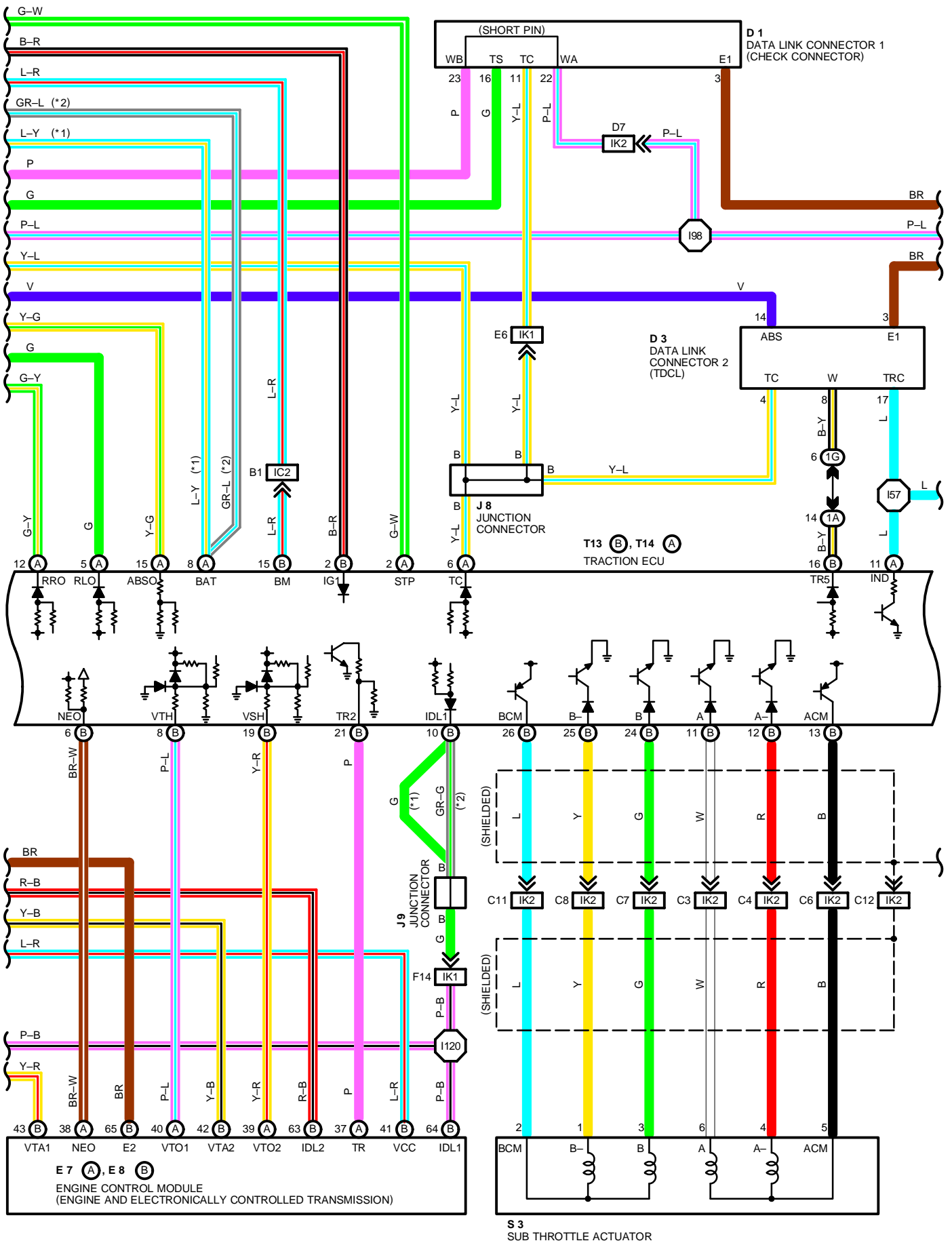



FROM POWER SOURCE SYSTEM (SEE PAGE 58)

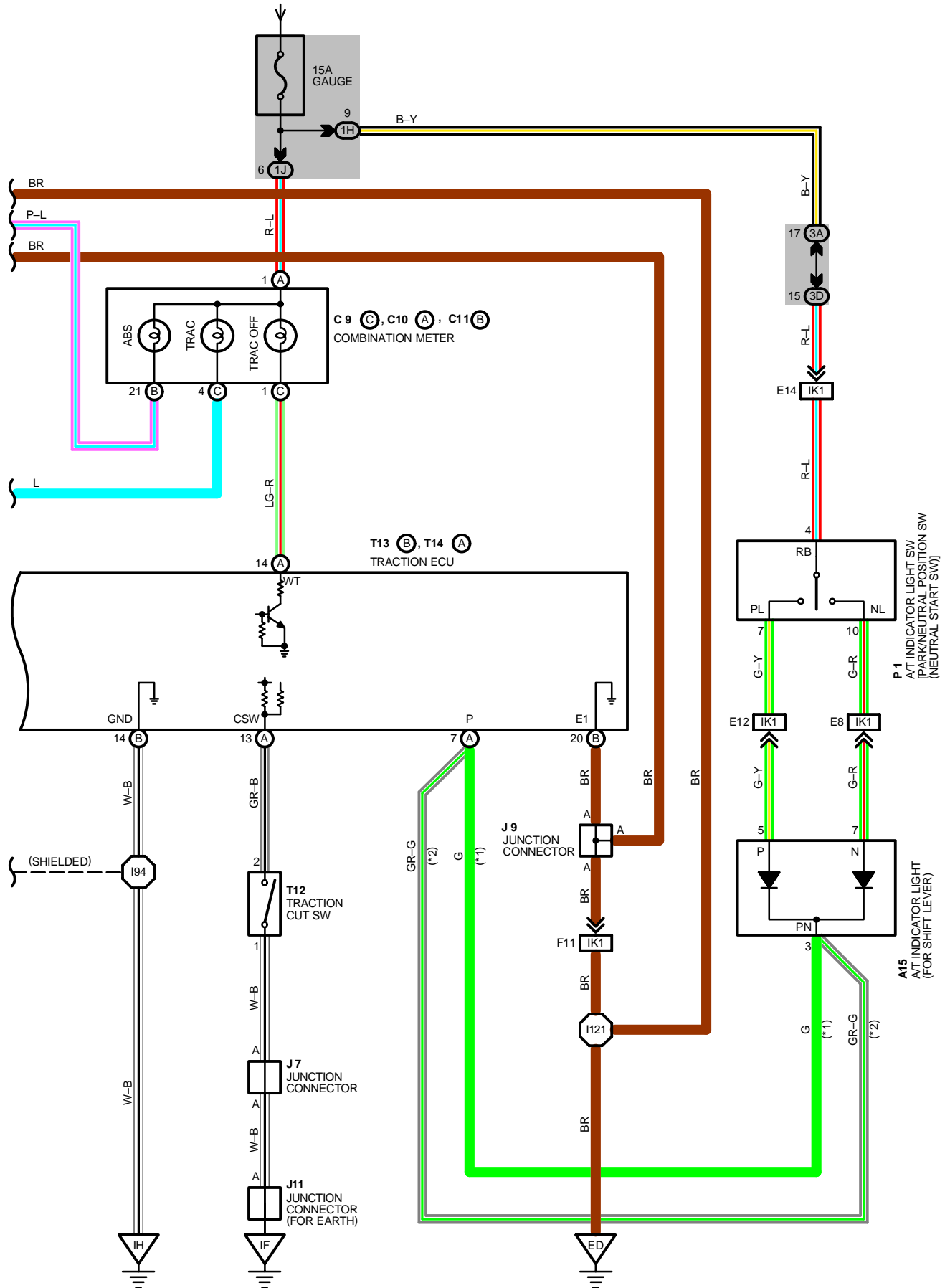

# ABS AND TRACTION CONTROL

## SERVICE HINTS

### A16(A), A17(B), A18(C) ABS AND TRACTION ECU

- (A) 7-GROUND : ALWAYS 10-14 VOLTS
- (A) 24-GROUND : 10-14 VOLTS WITH IGNITION SW AT ON POSITION
- (C) 6-GROUND : 10-14 VOLTS WITH STOP LIGHT SW ON
- (A) 25, (C) 4, (C) 9-GROUND : ALWAYS CONTINUITY
- (C) 12-GROUND : 10-14 VOLTS WITH PARKING BRAKE PEDAL DEPRESSED (PARKING BRAKE SW ON)

### A 4(B), A 5(A) ABS ACTUATOR

- (B) 1-GROUND : ALWAYS CONTINUITY
- (A) 1, (A) 3, (A) 4, (A) 6-GROUND : APPROX. 1.2 (IGNITION SW OFF)
- (A) 2-GROUND : 4-6 (IGNITION SW OFF)

### T 3(A), T 4(B) TRACTION ACTUATOR

- (B) 2 - (B) 4 : 5-7 VOLTS ABOVE APPROX. 12748 KPA (130 KG/CM<sup>2</sup>, 1846 PSI)
- : 10-14 VOLTS BELOW APPROX. 8630 KPA (88 KG/CM<sup>2</sup>, 1250 PSI)
- (A) 3 - (A) 6 : APPROX. 2.1
- (A) 2 - (A) 5 : APPROX. 2.1
- (A) 1 - (A) 4 : APPROX. 2.1

### S 9 STOP LIGHT SW

- 2-1 : CLOSED WITH BRAKE PEDAL DEPRESSED

### A 6, A 7, A27, A28 ABS SPEED SENSOR FRONT LH, RH, REAR LH, RH

- 1-2 : 0.8-1.2 K (20°C, 68°F)

### T13(B), T14(A) TRACTION ECU

- (B) 2-GROUND : 10-14 VOLTS WITH IGNITION SW AT ON POSITION
- (B) 15-GROUND : ALWAYS 10-14 VOLTS
- (B) 14, (B) 20-GROUND : ALWAYS BELOW 1 VOLTS
- (B) 1-GROUND : 10-14 VOLTS WITH IGNITION SW ON PARKING BRAKE LEVER RELEASED (PARKING BRAKE SW OFF)
- (A) 2-GROUND : 10-14 VOLTS WITH STOP LIGHT SW ON
- (A) 13-GROUND : 10-14 VOLTS WITH TRACTION CUT SW RELEASED
- (A) 8-GROUND : ALWAYS 10-14 VOLTS

### P 4 PARKING BRAKE SW

- 1-GROUND : CLOSED WITH PARKING BRAKE PEDAL DEPRESSED

### S 3 SUB THROTTLE ACTUATOR

- 2-1, 2-3 : APPROX. 1.1
- 5-4, 5-6 : APPROX. 1.1

## ○ : PARTS LOCATION

CODE	SEE PAGE	CODE	SEE PAGE	CODE	SEE PAGE
A 4	B 26	D 1	26	P 4	29
A 5	A 26	D 3	28	S 3	27
A 6	26	D 4	28	S 4	27
A 7	26	D 7	28	S 9	29
A15	28	E 7	A 28	T 2	27
A16	A 28	E 8	B 28	T 3	A 27
A17	B 28	G 2	26	T 4	B 27
A18	C 28	J 1	27	T 5	27
A27	30	J 2	29	T 6	27
A28	30	J 7	29	T12	29
B 1	26	J 8	29	T13	B 29
C 9	C 28	J 9	29	T14	A 29
C10	A 28	J11	29		
C11	B 28	P 1	27		

## ○ : RELAY BLOCKS

CODE	SEE PAGE	RELAY BLOCKS (RELAY BLOCK LOCATION)
2	19	R/B NO. 2 (ENGINE COMPARTMENT LEFT)

 : JUNCTION BLOCK AND WIRE HARNESS CONNECTOR

CODE	SEE PAGE	JUNCTION BLOCK AND WIRE HARNESS (CONNECTOR LOCATION)
1A	20	COWL WIRE AND J/B NO. 1 (LEFT KICK PANEL)
1B		
1D		
1G		
1H		
1J		
3A	22	COWL WIRE AND J/B NO. 3 (BEHIND THE INSTRUMENT PANEL CENTER)
3D		
3E		

 : CONNECTOR JOINING WIRE HARNESS AND WIRE HARNESS

CODE	SEE PAGE	JOINING WIRE HARNESS AND WIRE HARNESS (CONNECTOR LOCATION)
EA1	34	ENGINE ROOM MAIN WIRE AND R/B NO. 2 WIRE (INSIDE OF R/B NO. 2)
EA2		
EB2	34	COWL WIRE AND R/B NO. 2 WIRE (INSIDE OF R/B NO. 2)
EC1	34	COWL WIRE AND ENGINE ROOM MAIN WIRE (INSIDE OF R/B NO. 2)
ED1	34	ENGINE ROOM MAIN WIRE AND ENGINE NO. 4 WIRE (NEAR THE R/B NO. 2)
IC2	36	ENGINE ROOM MAIN WIRE AND COWL WIRE (UNDER THE GLOVE BOX)
IE1	36	COWL WIRE AND FLOOR NO. 2 WIRE (LEFT KICK PANEL)
IK1	38	ENGINE WIRE AND COWL WIRE (UNDER THE GLOVE BOX)
IK2		
IM3	38	COWL WIRE AND FLOOR NO. 1 WIRE (RIGHT KICK PANEL)

 : GROUND POINTS

CODE	SEE PAGE	GROUND POINTS LOCATION
EA	34	FRONT SIDE OF RIGHT FENDER
EB	34	FRONT SIDE OF LEFT FENDER
ED	34	REAR SIDE OF INTAKE MANIFOLD
IE	36	LEFT KICK PANEL
IF	36	BEHIND COMBINATION METER
IH	36	RIGHT KICK PANEL

 : SPLICE POINTS

CODE	SEE PAGE	WIRE HARNESS WITH SPLICE POINTS	CODE	SEE PAGE	WIRE HARNESS WITH SPLICE POINTS
E 1	34	ENGINE ROOM MAIN WIRE	I107	38	COWL WIRE
E20	34	ENGINE WIRE	I120		
I57	38	COWL WIRE	I121		
I61			38	ENGINE WIRE	
I74					
I94					
I98			38	ENGINE ROOM MAIN WIRE	
I101					
I103					

A 4  BLACK



A 5  GRAY



A 6, A 7 GRAY



A15



A16 

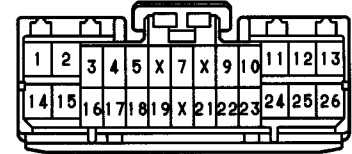

A17 

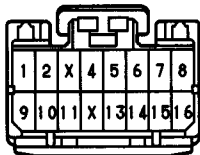

A18 

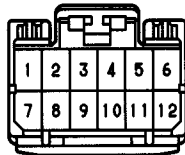

A27, A28 GRAY



B 1 GRAY



C 9 



# ABS AND TRACTION CONTROL

C10 (A) ORANGE

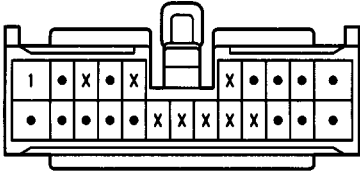

C11 (B) GRAY

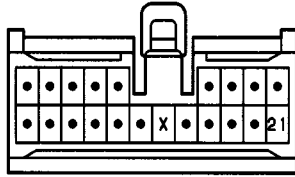

D 1 BLACK

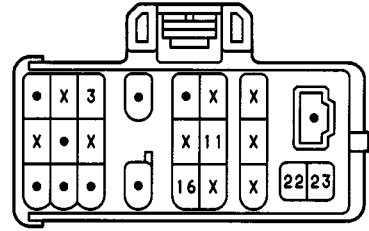

D 3

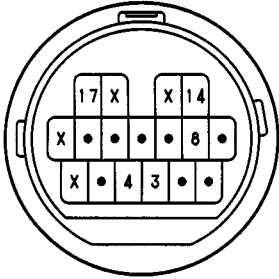

D 4 GRAY

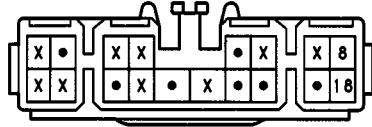

D 7 BLACK



E 7 (A) DARK GRAY

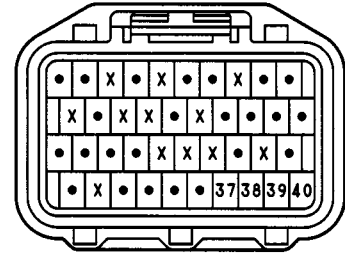

E 8 (B) DARK GRAY

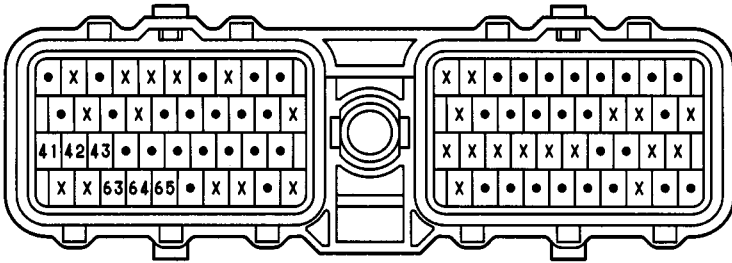

G 2 GRAY

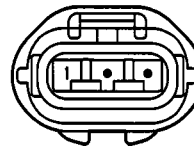

J 1



(HINT:SEE PAGE 7)

J 2

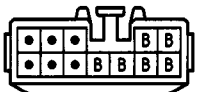

(HINT:SEE PAGE 7)

J 7 GRAY

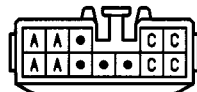

(HINT:SEE PAGE 7)

J 8

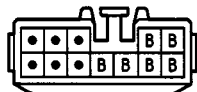

(HINT:SEE PAGE 7)

J 9 GRAY



(HINT:SEE PAGE 7)

J11

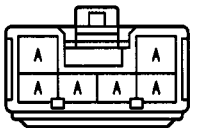

(HINT:SEE PAGE 7)

P 1 GRAY

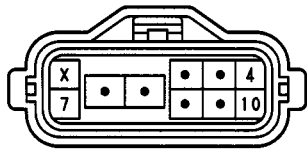

P 4 GRAY



S 3 GRAY



S 4 BLACK



S 9

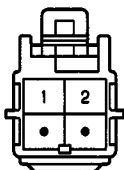

T 2 BLACK



T 3 (A) BLACK



T 4 (B) BLACK



T 5 GRAY

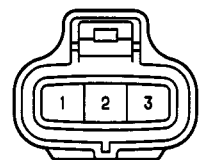

T 6 GRAY



T12



T13 (B) GRAY

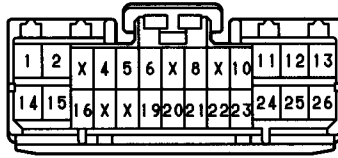

T14 (A) GRAY

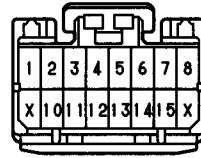

# ELECTRONICALLY CONTROLLED TRANSMISSION AND A/T INDICATOR

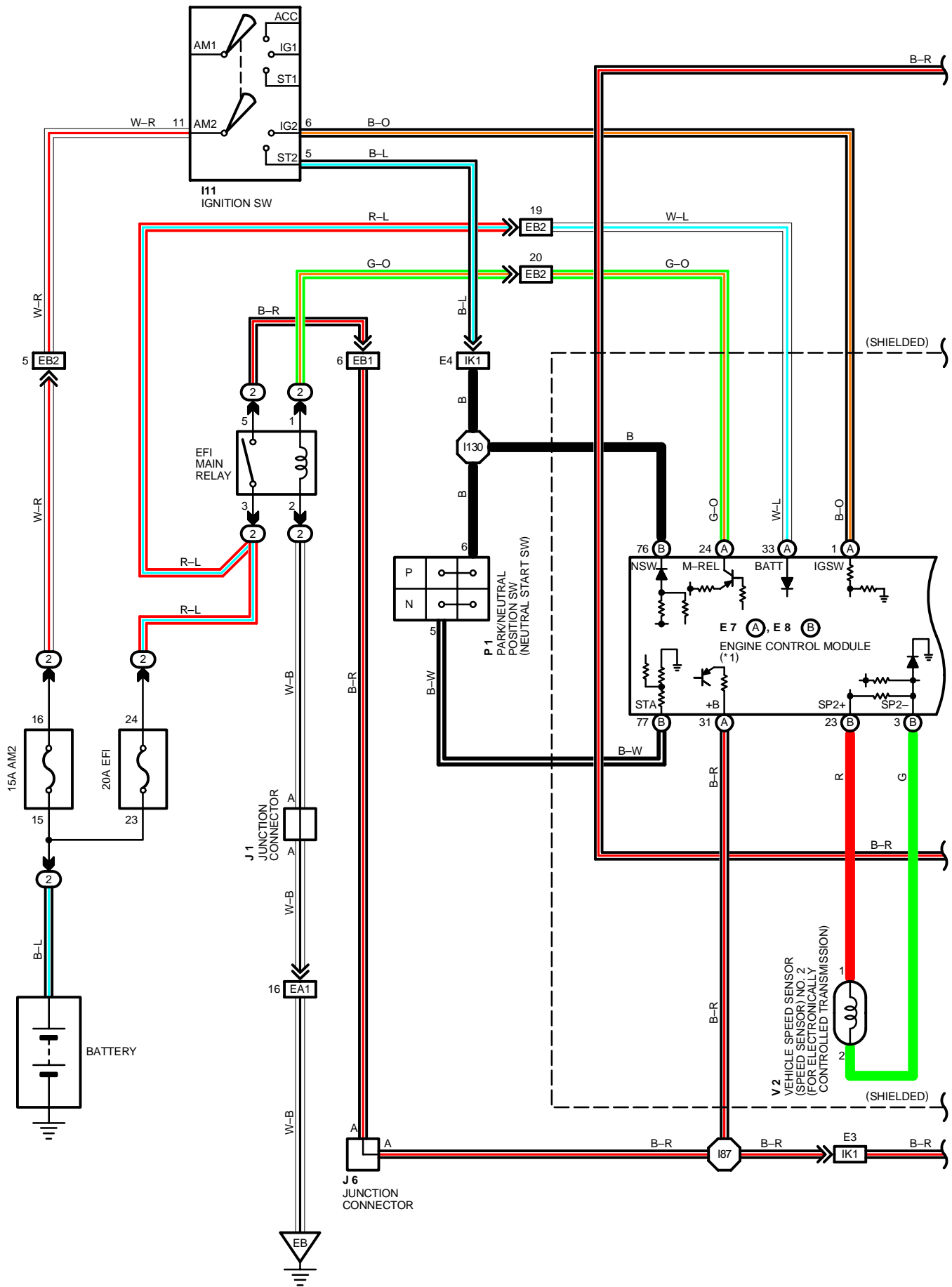

\*1 : ENGINE AND ELECTRONICALLY CONTROLLED TRANSMISSION ECU  
 \*2 : W/ TRACTION CONTROL

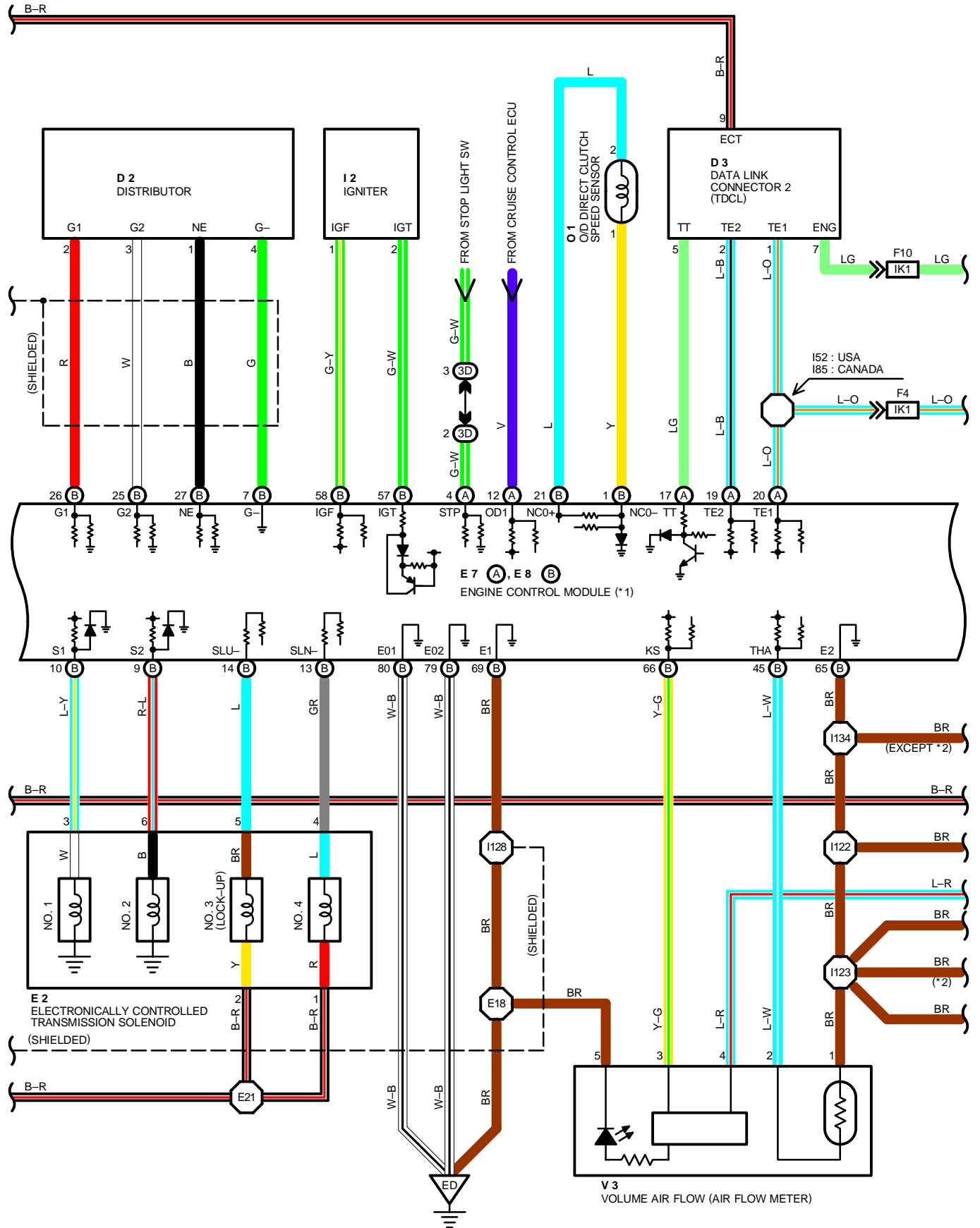

# ELECTRONICALLY CONTROLLED TRANSMISSION AND AT INDICATOR

FROM POWER SOURCE SYSTEM (SEE PAGE 58)

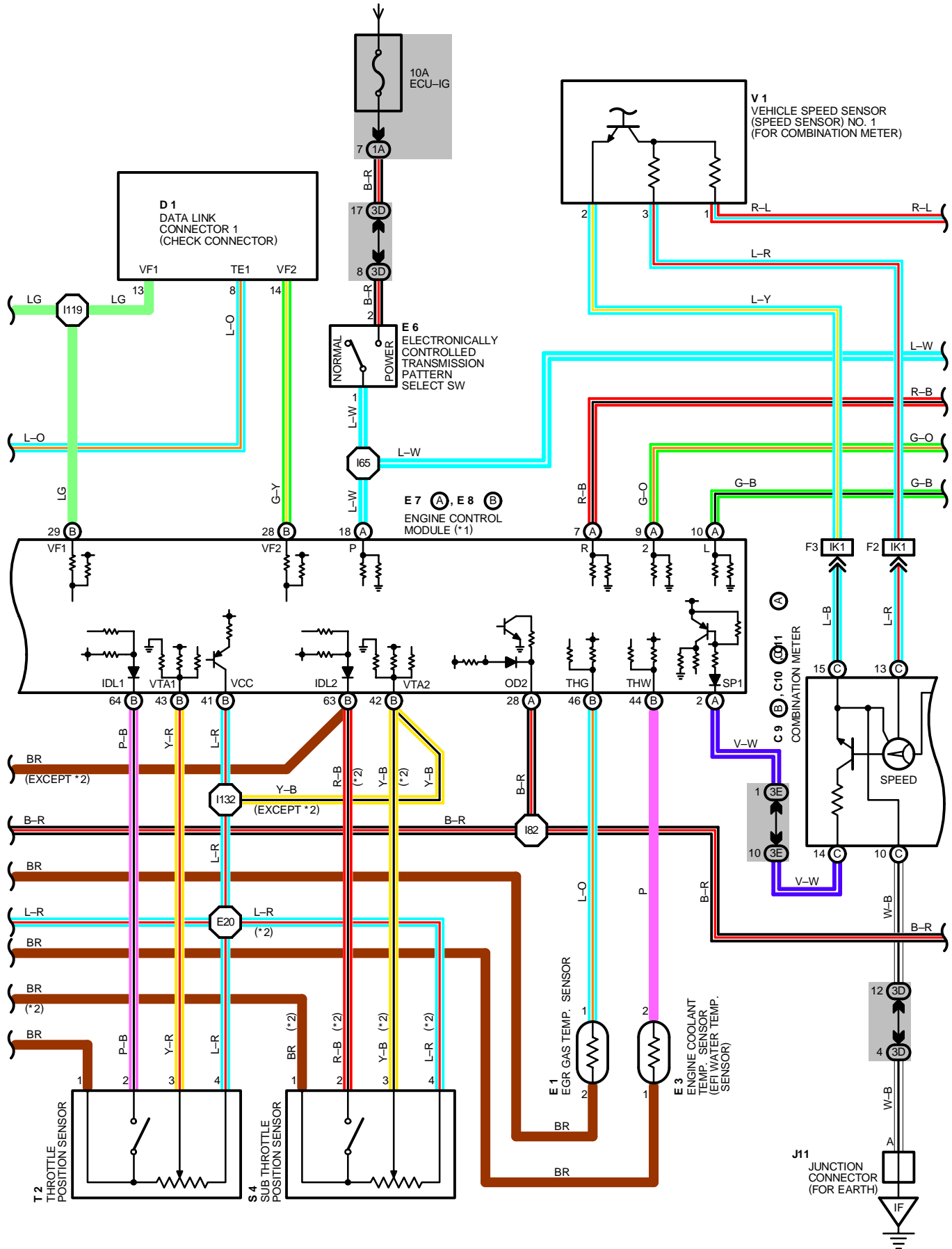



FROM POWER SOURCE SYSTEM (SEE PAGE 58)

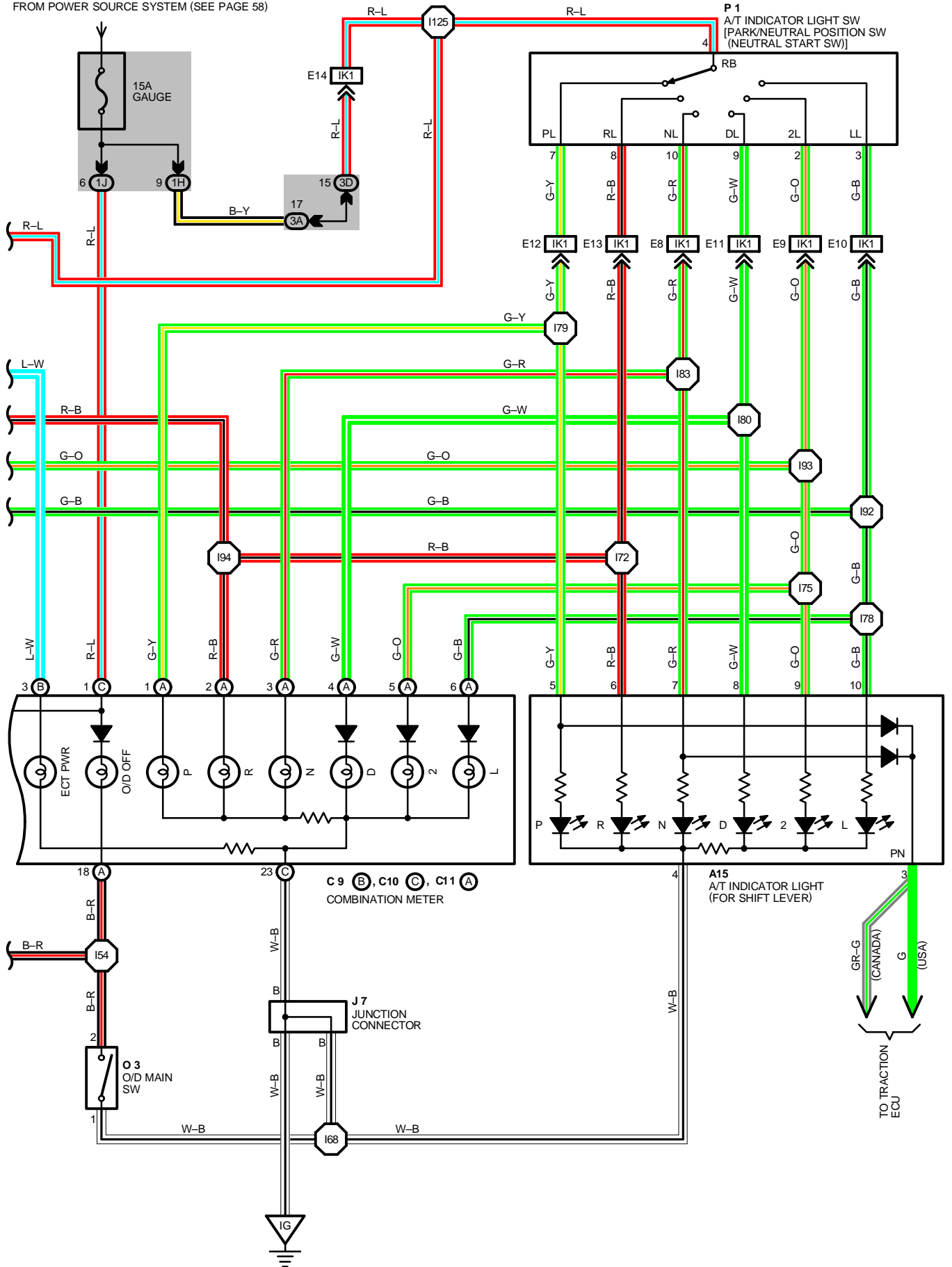

# ELECTRONICALLY CONTROLLED TRANSMISSION AND A/T INDICATOR

## SYSTEM OUTLINE

THIS SYSTEM ELECTRICALLY CONTROLS THE LINE PRESSURE, THROTTLE PRESSURE, LOCK-UP PRESSURE AND ACCUMULATOR PRESSURE ETC. THROUGH THE SOLENOID VALVE. THE ELECTRONICALLY CONTROLLED TRANSMISSION IS A SYSTEM WHICH PRECISELY CONTROLS GEAR SHIFT TIMING AND LOCK-UP TIMING IN RESPONSE TO THE VEHICLE'S DRIVING CONDITIONS AND THE ENGINE OPERATING CONDITIONS DETECTED BY VARIOUS SENSORS, MAKING SMOOTH DRIVING POSSIBLE BY SHIFT SELECTION FOR EACH GEAR WHICH IS THE MOST APPROPRIATE TO THE DRIVING CONDITIONS AT THAT TIME, AND CONTROLS THE ENGINE TORQUE DURING SHIFTING TO ACHIEVE OPTIMUM SHIFT FEELING.

### 1. GEAR SHIFT OPERATION

WHEN DRIVING THE ENGINE WARM UP CONDITION IS INPUT AS A SIGNAL TO **TERMINAL (B)44** OF THE ENGINE CONTROL MODULE (ENGINE AND ELECTRONICALLY CONTROLLED TRANSMISSION ECU) FROM THE ENGINE COOLANT TEMP. SENSOR (EFI WATER TEMP. SENSOR) AND THE VEHICLE SPEED SIGNAL FROM VEHICLE SPEED SENSOR (SPEED SENSOR) NO.2 IS INPUT TO **TERMINAL (B)23** OF THE ENGINE CONTROL MODULE (ENGINE AND ELECTRONICALLY CONTROLLED TRANSMISSION ECU). AT THE SAME TIME, THE THROTTLE VALVE OPENING SIGNAL FROM THE THROTTLE POSITION SENSOR IS INPUT TO **TERMINAL (B)43** OF THE ENGINE CONTROL MODULE (ENGINE AND ELECTRONICALLY CONTROLLED TRANSMISSION ECU) AS THROTTLE ANGLE SIGNAL.

BASED ON THESE SIGNALS, THE ENGINE CONTROL MODULE (ENGINE AND ELECTRONICALLY CONTROLLED TRANSMISSION ECU) SELECTS THE BEST SHIFT POSITION FOR DRIVING CONDITIONS AND SENDS CURRENT TO THE ELECTRONICALLY CONTROLLED TRANSMISSION SOLENOIDS. WHEN SHIFTING TO 1ST SPEED, THE CURRENT FLOWS FROM **TERMINAL (B)10** OF THE ENGINE CONTROL MODULE (ENGINE AND ELECTRONICALLY CONTROLLED TRANSMISSION ECU) → **TERMINAL 3** OF ELECTRONICALLY CONTROLLED TRANSMISSION SOLENOID → **GROUND** AND CONTINUITY TO NO.1 SOLENOID CAUSES THE SHIFT (NO.2 SOLENOID DOES NOT HAVE CONTINUITY AT THIS TIME).

FOR 2ND SPEED, THE CURRENT FLOWS SIMULTANEOUSLY FROM **TERMINAL (B)9** OF THE ENGINE CONTROL MODULE (ENGINE AND ELECTRONICALLY CONTROLLED TRANSMISSION ECU) → **TERMINAL 6** OF ELECTRONICALLY CONTROLLED TRANSMISSION SOLENOID → **GROUND**, AND FROM **TERMINAL (B)10** OF THE ENGINE CONTROL MODULE (ENGINE AND ELECTRONICALLY CONTROLLED TRANSMISSION ECU) → **TERMINAL 3** OF ELECTRONICALLY CONTROLLED TRANSMISSION SOLENOID → **GROUND**, AND CONTINUITY TO NO.1 AND NO.2 SOLENOIDS CAUSES THE SHIFT.

FOR 3RD SPEED, THERE IS NO CONTINUITY TO NO.1 SOLENOID, ONLY TO NO.2 SOLENOID, CAUSING THE SHIFT.

SHIFTING INTO THE 4TH SPEED (OVERDRIVE) OCCURS WHEN NO CURRENT FLOWS TO NO.1 AND NO.2 SOLENOIDS. THE NO.4 SOLENOID (FOR ACCUMULATOR BACK PRESSURE MODULATION) IS INSTALLED TO ADJUST THE BACK PRESSURE ON THE ACCUMULATOR AND CONTROL THE HYDRAULIC PRESSURE DURING SHIFTING AND LOCK-UP IN ORDER TO PROVIDE SMOOTH SHIFTING WITH LITTLE SHIFT SHOCK.

### 2. LOCK-UP OPERATION

WHEN THE ENGINE CONTROL MODULE (ENGINE AND ELECTRONICALLY CONTROLLED TRANSMISSION ECU) DECIDES, BASED ON EACH SIGNAL, THAT THE LOCK-UP CONDITION HAS BEEN MET, THE CURRENT THROUGH **EFI FUSE** FLOWS FROM THE **EFI MAIN RELAY** → **TERMINAL 2** OF ELECTRONICALLY CONTROLLED TRANSMISSION SOLENOID → **TERMINAL 5** → **TERMINAL (B)14** OF THE ENGINE CONTROL MODULE (ENGINE AND ELECTRONICALLY CONTROLLED TRANSMISSION ECU) → **GROUND**, SO CONTINUITY TO NO. 3 (FOR LOCK-UP) CAUSES LOCK-UP.

### 3. STOP LIGHT SW CIRCUIT

IF THE BRAKE PEDAL IS DEPRESSED (STOP LIGHT SW ON) WHEN DRIVING IN LOCK-UP CONDITION, A SIGNAL IS INPUT TO **TERMINAL (A)4** OF THE ENGINE CONTROL MODULE (ENGINE AND ELECTRONICALLY CONTROLLED TRANSMISSION ECU). THE ENGINE CONTROL MODULE (ENGINE AND ELECTRONICALLY CONTROLLED TRANSMISSION ECU) OPERATES AND CUTS THE CURRENT TO THE SOLENOID TO RELEASE LOCK-UP.

### 4. OVERDRIVE CIRCUIT

#### \* O/D MAIN SW ON

WHEN THE O/D MAIN SW IS TURNED ON (SW POINT IS OPEN), A SIGNAL IS INPUT TO **TERMINAL (A)28** OF THE ENGINE CONTROL MODULE (ENGINE AND ELECTRONICALLY CONTROLLED TRANSMISSION ECU) AND THE ELECTRONICALLY CONTROLLED TRANSMISSION CAUSES SHIFT TO OVERDRIVE WHEN THE CONDITIONS FOR OVERDRIVE ARE MET.

#### \* O/D MAIN SW OFF

WHEN THE O/D MAIN SW IS TURNED OFF (SW POINT IS CLOSED), THE CURRENT FLOWING THROUGH THE O/D OFF INDICATOR LIGHT FLOWS TO **GROUND** BY WAY OF THE O/D MAIN SW AND CAUSES THE O/D OFF INDICATOR LIGHT TO LIGHT UP. AT THE SAME TIME, A SIGNAL IS INPUT TO **TERMINAL (A)28** OF THE ENGINE CONTROL MODULE (ENGINE AND ELECTRONICALLY CONTROLLED TRANSMISSION ECU) AND THE ELECTRONICALLY CONTROLLED TRANSMISSION PREVENTS SHIFT INTO OVERDRIVE.

## 5. ELECTRONICALLY CONTROLLED TRANSMISSION PATTERN SELECT SW CIRCUIT

WHEN THE ELECTRONICALLY CONTROLLED TRANSMISSION PATTERN SELECT SW IS CHANGED FROM **NORMAL** TO **POWER**, THE CURRENT THROUGH THE **ECU-IG** FUSE FLOWS TO **TERMINAL 2** OF ELECTRONICALLY CONTROLLED TRANSMISSION PATTERN SELECT SW → **TERMINAL 1** → **TERMINAL (B)3** OF A/T INDICATOR (COMB. METER) → **TERMINAL (C)23** → **GROUND** AND CAUSES THE INDICATOR LIGHT TO LIGHT UP. AT THE SAME TIME, THE CURRENT FLOWS TO **TERMINAL (A)18** OF THE ENGINE CONTROL MODULE (ENGINE AND ELECTRONICALLY CONTROLLED TRANSMISSION ECU) AND THE ENGINE CONTROL MODULE (ENGINE AND ELECTRONICALLY CONTROLLED TRANSMISSION ECU) PERFORMS SHIFT UP AND SHIFT DOWN AT A HIGHER VEHICLE SPEED RANGE COMPARED WITH “**NORMAL**” POSITION.

## 6. CRUISE CONTROL

WHEN CRUISE CONTROL OPERATION IS SELECTED A SIGNAL IS INPUT TO **TERMINAL (A)12** OF THE ENGINE CONTROL MODULE (ENGINE AND ELECTRONICALLY CONTROLLED TRANSMISSION ECU) FROM CRUISE CONTROL ECU. AS A RESULT, THE ENGINE CONTROL MODULE (ENGINE AND ELECTRONICALLY CONTROLLED TRANSMISSION ECU) OPERATES AND CONTROLS OVERDRIVE, LOCK-UP AND SO ON FOR SMOOTH DRIVING.

## SERVICE HINTS

### E 2 ELECTRONICALLY CONTROLLED TRANSMISSION SOLENOID

6-GROUND : APPROX. 13.2  
 3-GROUND : APPROX. 13.2  
 4-1 : APPROX. 8.3  
 5-2 : APPROX. 3.8

### E 5 ENGINE COOLANT TEMP. SENSOR (EFI WATER TEMP. SENSOR)

1-2 : 10-20 K (-20°C -4°F)  
 4-7 K (0°C 32°F)  
 2-3 K (20°C 68°F)  
 0.9-1.3 K (40°C 104°F)  
 0.4-0.7 K (60°C 140°F)  
 0.2-0.4 K (80°C 176°F)

### E 7(A), E 8(B) ENGINE CONTROL MODULE (ENGINE AND ELECTRONICALLY CONTROLLED TRANSMISSION ECU)

BATT - E1: ALWAYS 9-14 VOLTS  
 IGSW - E1: 9-14 VOLTS WITH IGNITION SW ON  
 +B - E1: 9-14 VOLTS WITH IGNITION SW ON  
 IDL1 - E1: 0-1.5 VOLTS WITH IGNITION SW ON AND THROTTLE VALVE FULLY CLOSED  
 9-14 VOLTS WITH IGNITION SW ON AND THROTTLE VALVE FULLY OPEN  
 VTA1 - E1: 0.3-0.8 VOLTS WITH IGNITION SW ON AND THROTTLE VALVE FULLY CLOSED  
 3.2-4.9 VOLTS WITH IGNITION SW ON AND THROTTLE VALVE FULLY OPEN  
 STA - E1: 6-14 VOLTS WITH ENGINE CRANKING  
 M-REL- E1: 9-14 VOLTS WITH IGNITION SW ON  
 VCC - E1: 4.5-5.5 VOLTS WITH IGNITION SW ON  
 L-GROUND: APPROX. 12 VOLTS WITH SHIFT LEVER AT L RANGE  
 2-GROUND: APPROX. 12 VOLTS WITH SHIFT LEVER AT 2 RANGE  
 R-GROUND: APPROX. 12 VOLTS WITH SHIFT LEVER AT R RANGE

### O 1 O/D DIRECT CLUTCH SPEED SENSOR

1-2 : APPROX. 620

### V 2 VEHICLE SPEED SENSOR (SPEED SENSOR) NO. 2 (FOR ELECTRONICALLY CONTROLLED TRANSMISSION)

1-2 : APPROX. 620

### E 6 ELECTRONICALLY CONTROLLED TRANSMISSION PATTERN SELECT SW

2-1 : CLOSED WITH ELECTRONICALLY CONTROLLED TRANSMISSION PATTERN SELECT SW AT **POWER** POSITION

## ○ : PARTS LOCATION

CODE	SEE PAGE	CODE	SEE PAGE	CODE	SEE PAGE
A15	28	E 3	26	J11	29
C 9	B 28	E 6	28	O 1	27
C10	C 28	E 7	A 28	O 3	29
C11	A 28	E 8	B 28	P 1	27
D 1	26	I 2	26	S 4	27
D 2	26	I11	29	T 2	27
D 3	28	J 1	27	V 1	27
E 1	26	J 6	29	V 2	27
E 2	26	J 7	29	V 3	27

# ELECTRONICALLY CONTROLLED TRANSMISSION AND A/T INDICATOR

## ○ : RELAY BLOCKS

CODE	SEE PAGE	RELAY BLOCKS (RELAY BLOCK LOCATION)
2	19	R/B NO. 2 (ENGINE COMPARTMENT LEFT)

## ○ : JUNCTION BLOCK AND WIRE HARNESS CONNECTOR

CODE	SEE PAGE	JUNCTION BLOCK AND WIRE HARNESS (CONNECTOR LOCATION)
1A	20	COWL WIRE AND J/B NO. 1 (LEFT KICK PANEL)
1H		
1J		
3A	22	COWL WIRE AND J/B NO. 3 (BEHIND THE INSTRUMENT PANEL CENTER)
3D		
3E		

## □ : CONNECTOR JOINING WIRE HARNESS AND WIRE HARNESS

CODE	SEE PAGE	JOINING WIRE HARNESS AND WIRE HARNESS (CONNECTOR LOCATION)
EA1	34	ENGINE ROOM MAIN WIRE AND R/B NO. 2 WIRE (INSIDE OF R/B NO. 2)
EB1	34	COWL WIRE AND R/B NO. 2 WIRE (INSIDE OF R/B NO. 2)
EB2		
IK1	38	ENGINE WIRE AND COWL WIRE (UNDER THE GLOVE BOX)

## ▽ : GROUND POINTS

CODE	SEE PAGE	GROUND POINTS LOCATION
EB	34	FRONT SIDE OF LEFT FENDER
ED	34	REAR SIDE OF INTAKE MANIFOLD
IF	36	BEHIND COMBINATION METER
IG	36	BEHIND GLOVE BOX

## ○ : SPLICE POINTS

CODE	SEE PAGE	WIRE HARNESS WITH SPLICE POINTS	CODE	SEE PAGE	WIRE HARNESS WITH SPLICE POINTS
E18	34	ENGINE WIRE	I85	38	COWL WIRE
E20			I87		
E21			I89		
I52	38	COWL WIRE	I92	38	ENGINE WIRE
I54			I93		
I65			I94		
I68			I119		
I72			I122		
I75			I123		
I77			I125		
I78			I128		
I79			I130		
I80			I132		
I82	I134				
I83					

A15

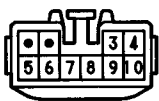

C 9 B



C10 C ORANGE

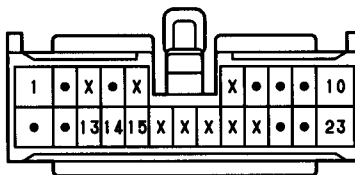

C11 A GRAY

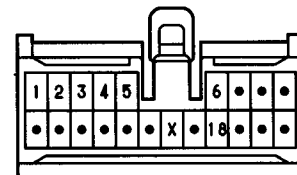

D 1 BLACK

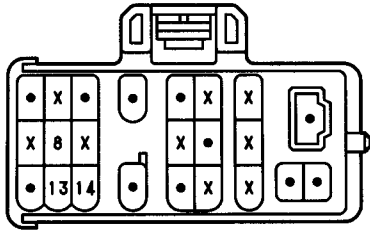

D 2 BLACK

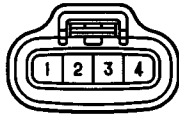

D 3

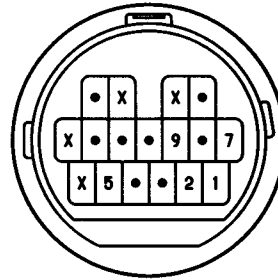

E 1 DARK GRAY



E 2 BLACK

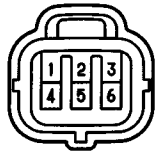

E 3 GREEN



E 6



E 7 (A) DARK GRAY

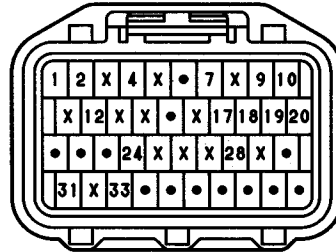

E 8 (B) DARK GRAY

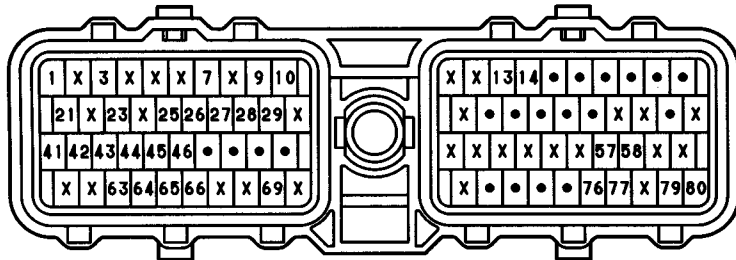

I 2 BLACK

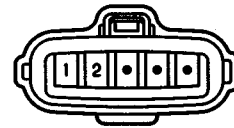

I 11 BLACK

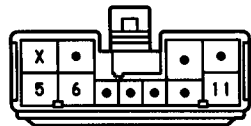

J 1



(HINT:SEE PAGE 7)

J 6 GRAY



(HINT:SEE PAGE 7)

J 7 GRAY



(HINT:SEE PAGE 7)

J 11

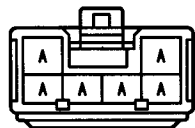

(HINT:SEE PAGE 7)

O 1 BLACK



O 3



P 1 GRAY

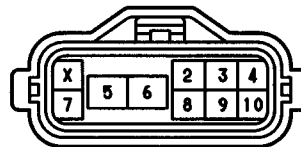

S 4 BLACK



T 2 BLACK



V 1 BLACK



V 2 BLACK



V 3 BLACK



# PPS (PROGRESSIVE POWER STEERING)

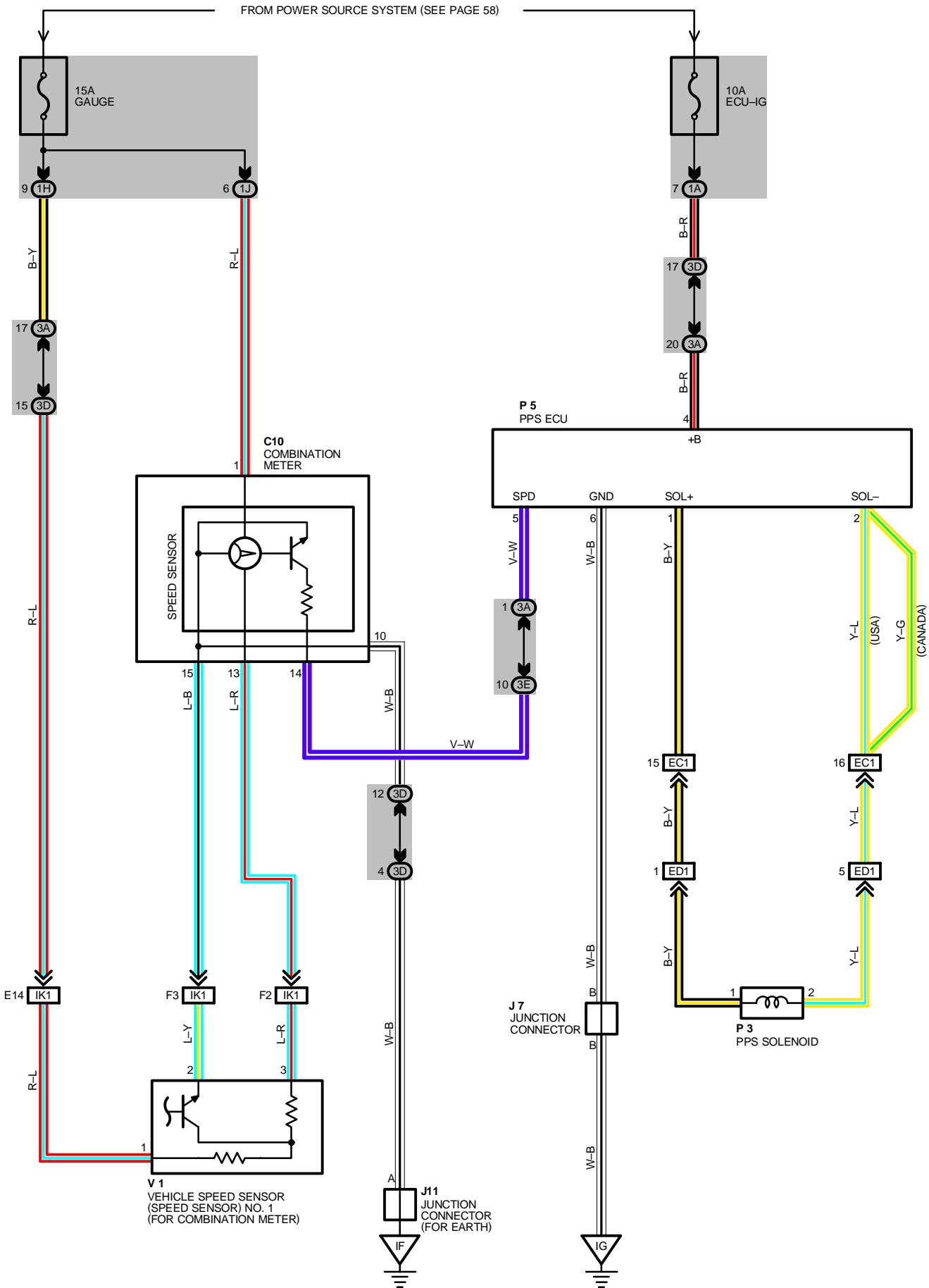

## SYSTEM OUTLINE

THE PPS (HYDRAULIC REACTION TYPE) CONTROLS THE HYDRAULIC PRESSURE APPLIED TO THE HYDRAULIC REACTION CHAMBER IN THE GEAR BOX CONTROL UNIT USING THE PPS ECU, TO CHANGE THE STEERING FORCE AND PROVIDE OPTIMUM STEERING FEELING AT ANY VEHICLE SPEED AND UNDER ANY STEERING CONDITIONS.

(PPS OPERATION)

WHEN THE IGNITION SW IS TURNED ON THE STARTING CURRENT FLOWS FROM THE **ECU-IG** FUSE TO **TERMINAL 4** OF THE PPS ECU. THE PPS ECU MONITORS VEHICLE SPEED, INPUT SIGNAL TO **TERMINAL 5** OF THE ECU. WHEN THE VEHICLE SPEED IS LOW, THE PPS ECU SENDS A HIGHER-CURRENT FROM **TERMINAL 1** OF THE ECU → **TERMINAL 1** OF THE SOLENOID VALVE → **TERMINAL 2** → **TERMINAL 2** OF THE ECU → **TERMINAL 6** → **GROUND**, INCREASING THE SOLENOID VALVE OPENING ANGLE TO PROVIDE COMFORTABLE STEERING OPERATION. WHEN THE VEHICLE SPEED IS HIGH, THE PPS ECU DECREASES THE SOLENOID VALVE OPENING ANGLE BY REDUCING THE CURRENT TO THE VALVE TO PROVIDE RESPONSIVE STEERING FEELING.

## SERVICE HINTS

### P 3 PPS SOLENOID

1-2 : APPROX. 7.7 (25°C, 77°F)

### P 5 PPS ECU

4-GROUND: APPROX. 12 VOLTS WITH IGNITION SW AT ON POSITION

6-GROUND : ALWAYS CONTINUITY

1-2 : APPROX. 0.8 A WITH VEHICLE SPEED BELOW 20 KM/H (12 MPH)

APPROX. 0.45 A WITH VEHICLE SPEED AT 80 KM/H (48 MPH)

APPROX. 0.2 A WITH VEHICLE SPEED ABOVE 160 KM/H (96 MPH)

## ○ : PARTS LOCATION

CODE	SEE PAGE	CODE	SEE PAGE	CODE	SEE PAGE
<b>C10</b>	28	<b>J11</b>	29	<b>P 5</b>	29
<b>J 7</b>	29	<b>P 3</b>	27	<b>V 1</b>	27

## ○ : JUNCTION BLOCK AND WIRE HARNESS CONNECTOR

CODE	SEE PAGE	JUNCTION BLOCK AND WIRE HARNESS (CONNECTOR LOCATION)
<b>1A</b>	20	COWL WIRE AND J/B NO. 1 (LEFT KICK PANEL)
<b>1H</b>		
<b>1J</b>		
<b>3A</b>	22	COWL WIRE AND J/B NO. 3 (BEHIND THE INSTRUMENT PANEL CENTER)
<b>3D</b>		
<b>3E</b>		

## □ : CONNECTOR JOINING WIRE HARNESS AND WIRE HARNESS

CODE	SEE PAGE	JOINING WIRE HARNESS AND WIRE HARNESS (CONNECTOR LOCATION)
<b>EC1</b>	34	COWL WIRE AND ENGINE ROOM MAIN WIRE (INSIDE OF R/B NO. 2)
<b>ED1</b>	34	ENGINE ROOM MAIN WIRE AND ENGINE NO. 4 WIRE (NEAR THE R/B NO. 2)
<b>IK1</b>	38	ENGINE WIRE AND COWL WIRE (UNDER THE GLOVE BOX)

## ▽ : GROUND POINTS

CODE	SEE PAGE	GROUND POINTS LOCATION
<b>IF</b>	36	BEHIND COMBINATION METER
<b>IG</b>	36	BEHIND GLOVE BOX

C10 ORANGE

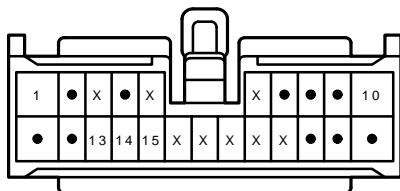

J 7 GRAY

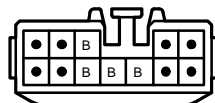

(HINT : SEE PAGE 7)

J11

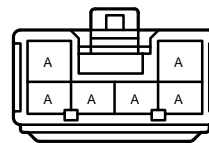

(HINT : SEE PAGE 7)

P 3 GRAY



P 5 BLUE



V 1 BLACK

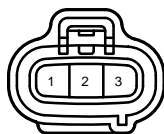

---



## SRS (SUPPLEMENTAL RESTRAINT SYSTEM)

**NOTICE:** When inspecting or repairing the SRS (supplemental restraint system), perform the operation in accordance with the following precautionary instructions and the procedure and precautions in the Repair Manual for the applicable model year.

- ▼ Malfunction symptoms of the supplemental restraint system are difficult to confirm, so the diagnostic trouble codes become the most important source of information when troubleshooting.  
When troubleshooting the supplemental restraint system, always inspect the diagnostic trouble codes before disconnecting the battery.
- ▼ Work must be started after 90 seconds from the time the Ignition SW is set to the “LOCK” position and the negative (–) terminal cable is disconnected from the battery.  
(The supplemental restraint system is equipped with a back-up power source so that if work is started within 90 seconds of disconnecting the negative (–) terminal cable of the battery, the SRS may be activated.)  
When the negative (–) terminal cable is disconnected from the battery, memory of the clock and audio systems will be cancelled. So before starting work, make a record of the contents memorized by each memory system. When work is finished, reset the clock and audio system as before and adjust the clock. This vehicle has tilt and telescopic steering, power seat and outside rear view mirror and power shoulder belt anchorage, which are all equipped with memory function, it is not possible to make a record of the memory contents. So when the work is finished, therefore it will be necessary to explain this fact to the customer, and ask the customer to adjust the features and reset the memory.  
To avoid erasing the memory of each memory system, never use a back-up power supply from outside the vehicle.
- ▼ When removing the steering wheel pad or handling a new steering wheel pad, keep the pad upper surface facing upward. Also, lock the lock lever of the twin lock type connector at the rear of the pad and take care not to damage the connector.  
(Storing the pad with its metallic surface up may lead to a serious accident if the SRS inflates for some reason.)
- ▼ Store the steering wheel pad where the ambient temperature remains below 93°C (200°F), without high humidity and away from electrical noise.
- ▼ Never use SRS parts from another vehicle. When replacing SRS parts, replace them with new parts.
- ▼ Never disassemble and repair the steering wheel pad, center SRS sensor assembly or front airbag sensors.
- ▼ Before repairing the body, remove the airbag sensors if during repair shocks are likely to be applied to the sensors due to vibration of the body or direct tapping with tools or other parts.
- ▼ Do not reuse a steering wheel pad or front airbag sensors.  
After evaluating whether the center airbag sensor assembly is damaged or not, decide whether or not to reuse it. (See the Repair Manual for the method for evaluating the center airbag sensor assembly.)
- ▼ When troubleshooting the supplemental restraint system, use a high-impedance (Min. 10kΩ/V) tester.
- ▼ The wire harness of the supplemental restraint system is integrated with the cowl No. wire harness assembly, engine room main wire harness assembly, floor No. 1 wire harness assembly and floor No. 2 wire harness assembly.  
The vehicle wiring harness exclusively for the airbag system is distinguished by corrugated yellow tubing, as are the connectors.
- ▼ Do not measure the resistance of the airbag squib.  
(It is possible this will deploy the airbag and is very dangerous.)
- ▼ If the wire harness used in the supplemental restraint system is damaged, replace the whole wire harness assembly.  
When the connector to the airbag front sensors can be repaired alone (when there is no damage to the wire harness), use the repair wire specially designed for the purpose.  
(Refer to the Repair Manual for the applicable Model year for details of the replacement method.)
- ▼ INFORMATION LABELS (NOTICES) are attached to the periphery of the SRS components. Follow the instructions on the notices.

# SRS (SUPPLEMENTAL RESTRAINT SYSTEM)

The supplemental restraint system has connectors which possess the functions described below:

## 1. SRS ACTIVATION PREVENTION MECHANISM

Each connector contains a short spring plate. When the connector is disconnected, the short spring plate automatically connects the power source and grounding terminals of the squib to preclude a potential difference between the terminals.

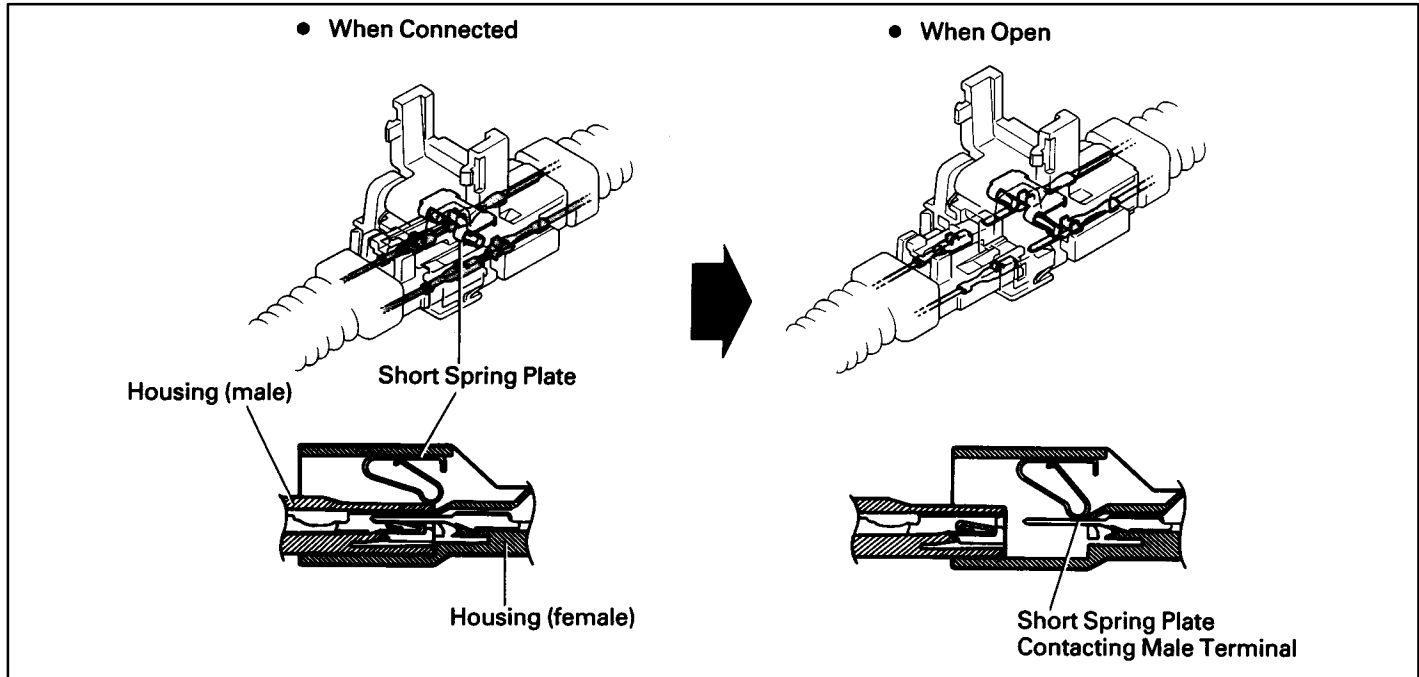

## 2. ELECTRICAL CONNECTION CHECK MECHANISM

This mechanism is designed to electrically check if connectors are connected correctly and completely.

The electrical connection check mechanism is designed so that the connection detection pin connects with the diagnosis terminals when the connector housing lock is in the locked condition.

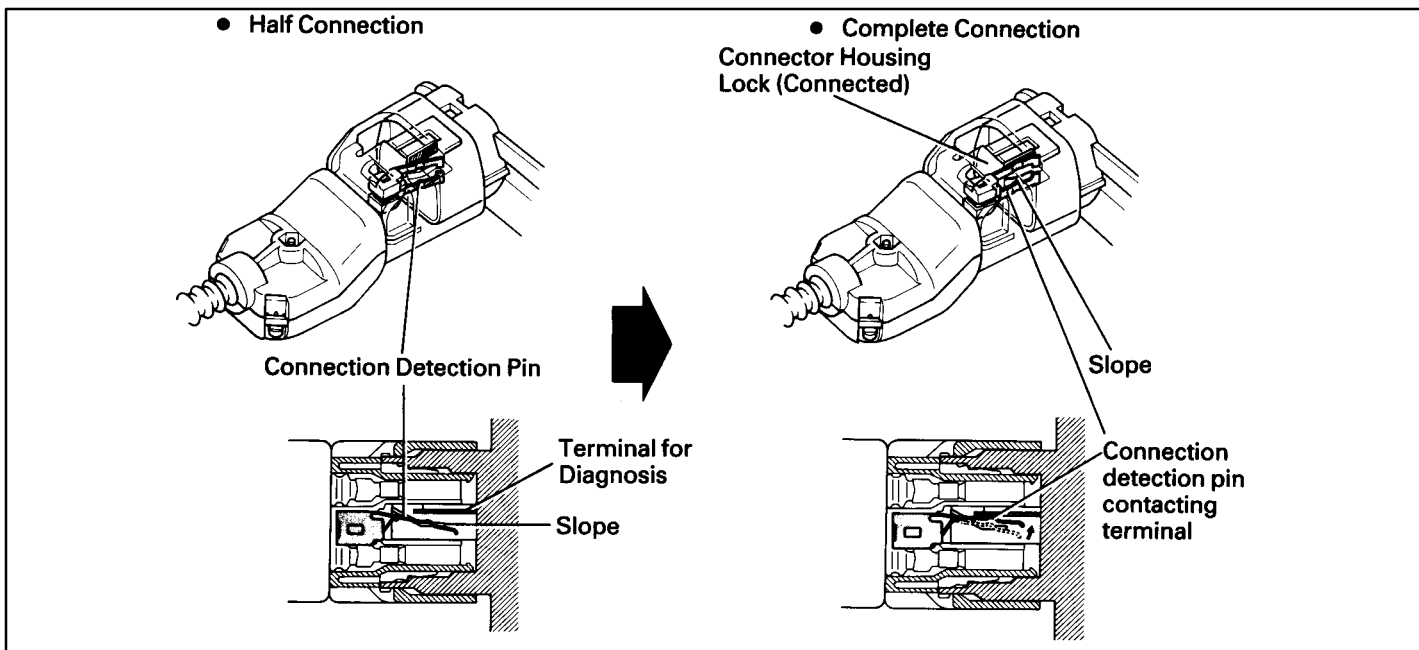

### 3. CONNECTOR TWIN-LOCK MECHANISM

With this mechanism connectors (male and female connectors) are locked by two locking devices to increase connection reliability. If the primary lock is incomplete, ribs interfere and prevent the secondary lock.

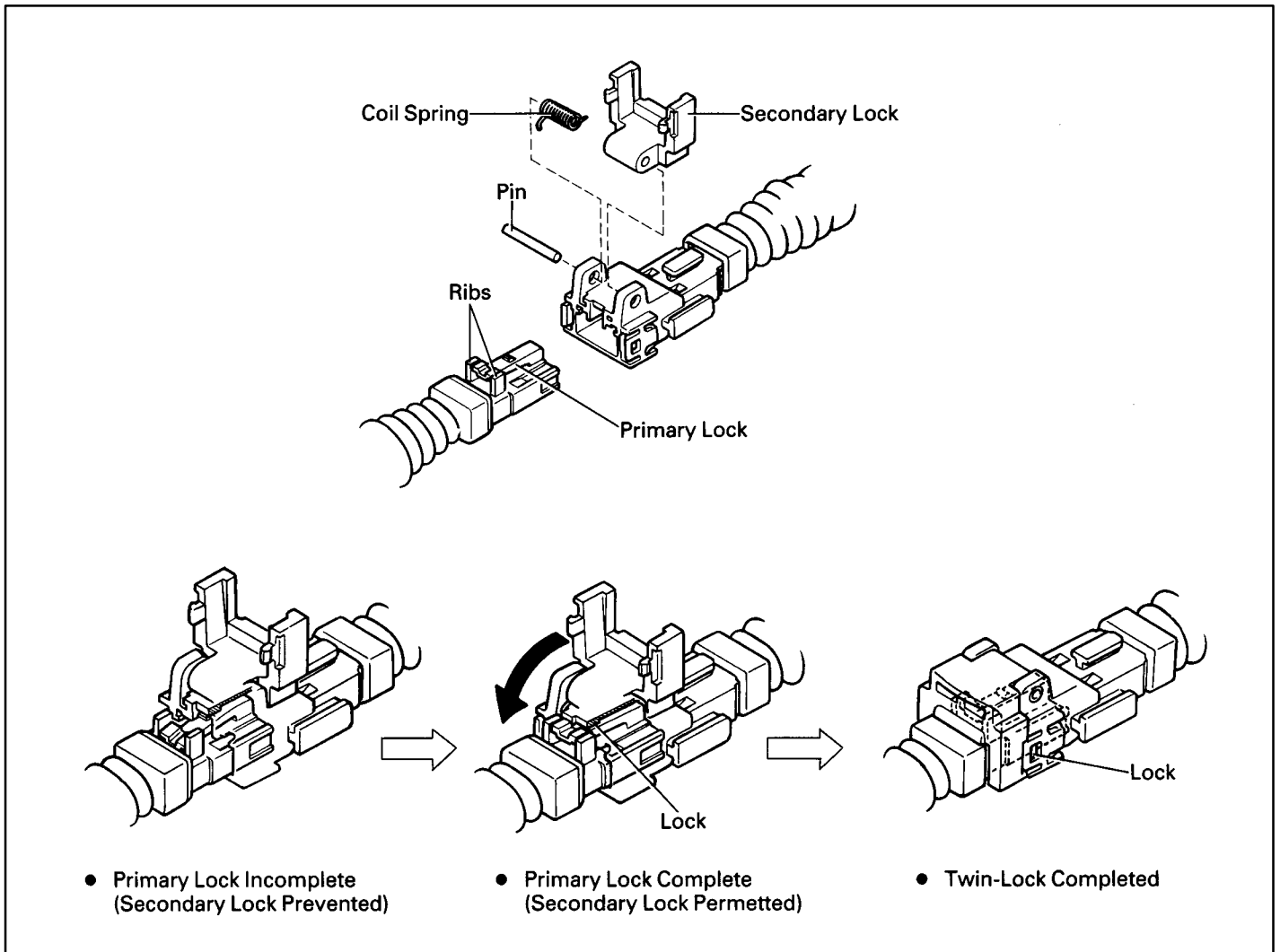

# SRS (SUPPLEMENTAL RESTRAINT SYSTEM)

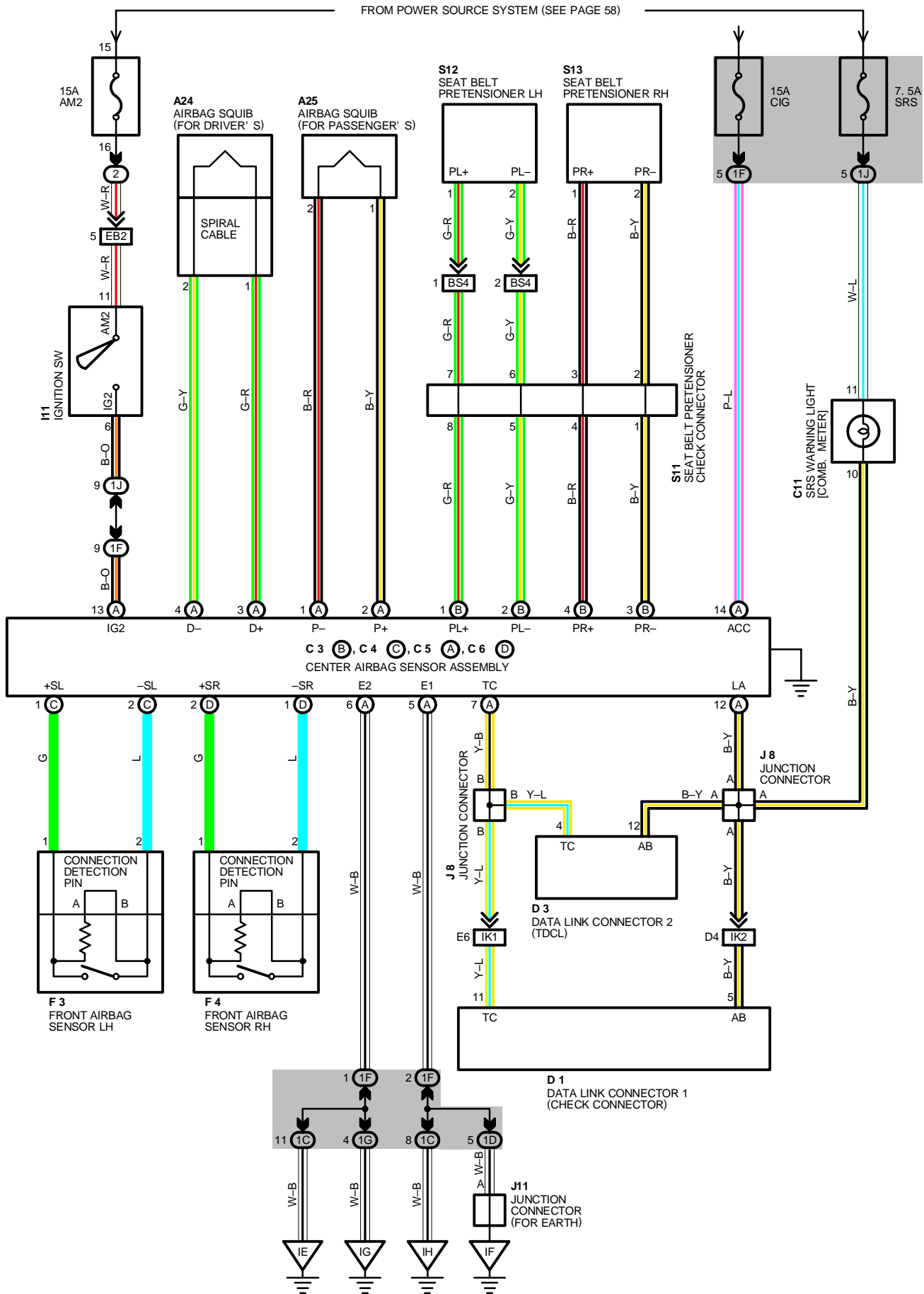

**SYSTEM OUTLINE**

THE SRS (SUPPLEMENTAL RESTRAINT SYSTEM) IS A DRIVER AND PASSENGER PROTECTION DEVICE WHICH HAS A SUPPLEMENTAL ROLE TO THE SEAT BELTS.

WHEN THE IGNITION SW IS TURNED TO ACC OR ON, CURRENT FROM THE **CIG** FUSE FLOWS TO **TERMINAL (A)14** OF THE CENTER AIRBAG SENSOR ASSEMBLY. ONLY WHEN THE IGNITION SW IS ON DOES THE CURRENT FROM THE **AM2** FUSE TO **TERMINAL (A)13**. IF AN ACCIDENT OCCURS WHILE DRIVING, DECELERATION CAUSED BY A FRONTAL IMPACT IS DETECTED BY EACH SENSOR AND SWITCH, AND WHEN THE FRONTAL IMPACT EXCEEDS A SET LEVEL (WHEN THE SAFING SENSOR BUILT INTO THE CENTER AIRBAG SENSOR ASSEMBLY IS ON AND THE CENTER AIRBAG SENSOR IS ON, FRONT AIRBAG SENSORS ARE OFF), CURRENT FROM THE **CIG** OR **AM2** FUSE FLOWS TO **TERMINALS (A)3, (A)2, (B)4** AND **(B)1** OF THE CENTER AIRBAG SENSOR ASSEMBLY → **TERMINAL 1** OF THE AIRBAG SQUIB AND SEAT BELT PRETENSIONER → **TERMINAL 2** → **TERMINAL (A)4, (A)1, (B)3** AND **(B)2** OF THE CENTER AIRBAG SENSOR ASSEMBLY → **TERMINAL (A)5, TERMINAL (A)6** OR **BODY** → **GROUND**.

WHEN THE SAFING SENSOR BUILT INTO THE CENTER AIRBAG SENSOR ASSEMBLY IS ON AND THE FRONT AIRBAG SENSOR LH OR RH IS ON, CENTER AIRBAG SENSOR IS OFF AND CURRENT FROM THE **CIG** OR **AM2** FUSE FLOWS TO **TERMINALS (A)3, (A)2, (B)4** AND **(B)1** OF THE CENTER AIRBAG SENSOR ASSEMBLY → **TERMINAL 1** OF THE AIRBAG SQUIB AND SEAT BELT PRETENSIONER → **TERMINAL 2** → **TERMINALS (A)4, (A)1, (B)3** AND **(B)2** OF THE CENTER AIRBAG SENSOR ASSEMBLY → **TERMINAL (C)1** OR **(D)2** → **TERMINAL 1** OF THE FRONT AIRBAG SENSOR → **TERMINAL 2** → **TERMINAL (C)2** OR **(D)1** OF THE CENTER AIRBAG SENSOR ASSEMBLY → **TERMINAL (A)5, TERMINAL (A)6** OR **BODY GROUND** → **GROUND**, WHEN THE SAFING SENSOR BUILT INTO THE CENTER AIRBAG SENSOR ASSEMBLY IS ON, AND THE FRONT AIRBAG SENSOR LH OR RH IS ON AND CENTER AIRBAG SENSOR IS ON ONE OF THE ABOVE-MENTIONED CIRCUITS IS ACTIVATED SO THAT CURRENT FLOWS TO THE AIRBAG SQUIBS AND CAUSES THEM TO OPERATE.

THE AIRBAG STORED INSIDE THE STEERING WHEEL PAD IS INSTANTANEOUSLY EXPANDED TO SOFTEN THE SHOCK TO THE DRIVER.

THE AIRBAG STORED INSIDE THE PASSENGER'S INSTRUMENT PANEL IS INSTANTANEOUSLY EXPANDED TO SOFTEN THE SHOCK TO THE PASSENGER.

**○ : PARTS LOCATION**

CODE	SEE PAGE	CODE	SEE PAGE	CODE	SEE PAGE
<b>A24</b>	28	<b>C11</b>	28	<b>J 8</b>	29
<b>A25</b>	28	<b>D 1</b>	26	<b>J11</b>	29
<b>C 3</b>	B 28	<b>D 3</b>	28	<b>S11</b>	31
<b>C 4</b>	C 28	<b>F 3</b>	26	<b>S12</b>	31
<b>C 5</b>	A 28	<b>F 4</b>	26	<b>S13</b>	31
<b>C 6</b>	D 28	<b>I11</b>	29		

**○ : RELAY BLOCKS**

CODE	SEE PAGE	RELAY BLOCKS (RELAY BLOCK LOCATION)
<b>2</b>	19	R/B NO. 2 (ENGINE COMPARTMENT LEFT)

**○ : JUNCTION BLOCK AND WIRE HARNESS CONNECTOR**

CODE	SEE PAGE	JUNCTION BLOCK AND WIRE HARNESS (CONNECTOR LOCATION)
<b>1C</b>	20	COWL WIRE AND J/B NO. 1 (LEFT KICK PANEL)
<b>1D</b>		
<b>1F</b>		
<b>1G</b>		
<b>1J</b>		

**□ : CONNECTOR JOINING WIRE HARNESS AND WIRE HARNESS**

CODE	SEE PAGE	JOINING WIRE HARNESS AND WIRE HARNESS (CONNECTOR LOCATION)
<b>EB2</b>	34	COWL WIRE AND R/B NO. 2 WIRE (INSIDE OF R/B NO. 2)
<b>IK1</b>	38	ENGINE WIRE AND COWL WIRE (UNDER THE GLOVE BOX)
<b>IK2</b>		
<b>BS4</b>	40	FLOOR NO. 1 WIRE AND FLOOR NO. 2 WIRE (UNDER THE LEFT SIDE OF REAR SEAT CUSHION)

**▽ : GROUND POINTS**

CODE	SEE PAGE	GROUND POINTS LOCATION
<b>IE</b>	36	LEFT KICK PANEL
<b>IF</b>	36	BEHIND COMBINATION METER
<b>IG</b>	36	BEHIND GLOVE BOX
<b>IH</b>	36	RIGHT KICK PANEL

# SRS (SUPPLEMENTAL RESTRAINT SYSTEM)

A24, A25  
S12, S13 YELLOW



C 3 (B) YELLOW

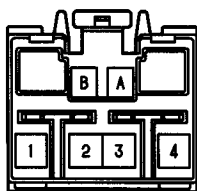

C 4 (C) YELLOW

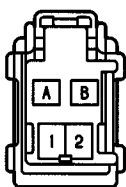

C 5 (A) YELLOW

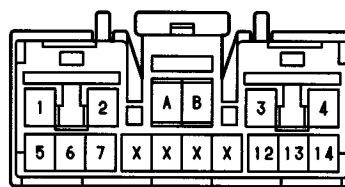

C 6 (D) YELLOW

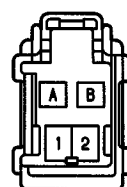

C11 GRAY

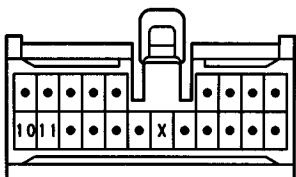

D 1 BLACK

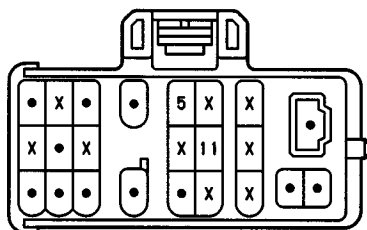

D 3

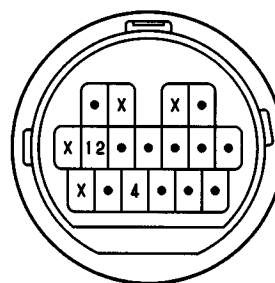

F 3, F 4 YELLOW

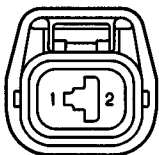

I11 BLACK

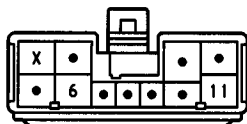

J 8



(HINT:SEE PAGE 7)

J11

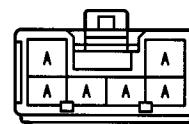

(HINT:SEE PAGE 7)

S11 YELLOW



# POWER TILT AND POWER TELESCOPIC

## ○ : PARTS LOCATION

CODE	SEE PAGE	CODE	SEE PAGE	CODE	SEE PAGE
C14	28	J 7	29	T 9	B 29
I11	29	J11	29	T10	A 29
J 4	29	P 1	27	T11	29

## ○ : RELAY BLOCKS

CODE	SEE PAGE	RELAY BLOCKS (RELAY BLOCK LOCATION)
2	19	R/B NO. 2 (ENGINE COMPARTMENT LEFT)

## ○ : JUNCTION BLOCK AND WIRE HARNESS CONNECTOR

CODE	SEE PAGE	JUNCTION BLOCK AND WIRE HARNESS (CONNECTOR LOCATION)
1A	20	COWL WIRE AND J/B NO. 1 (LEFT KICK PANEL)
1C		
1H		
1K		
3A	22	COWL WIRE AND J/B NO. 3 (BEHIND THE INSTRUMENT PANEL CENTER)
3D		
3E		

## □ : CONNECTOR JOINING WIRE HARNESS AND WIRE HARNESS

CODE	SEE PAGE	JOINING WIRE HARNESS AND WIRE HARNESS (CONNECTOR LOCATION)
EB1	34	COWL WIRE AND R/B NO. 2 WIRE (INSIDE OF R/B NO. 2)
IK1	38	ENGINE WIRE AND COWL WIRE (UNDER THE GLOVE BOX)

## ▽ : GROUND POINTS

CODE	SEE PAGE	GROUND POINTS LOCATION
IF	36	BEHIND COMBINATION METER
IG	36	BEHIND GLOVE BOX

## ○ : SPLICE POINTS

CODE	SEE PAGE	WIRE HARNESS WITH SPLICE POINTS	CODE	SEE PAGE	WIRE HARNESS WITH SPLICE POINTS
I55	38	COWL WIRE	I125	38	ENGINE WIRE

(USA) C14 GRAY

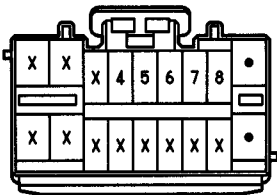

(CANADA) C14 GRAY

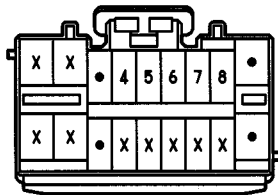

I11 BLACK

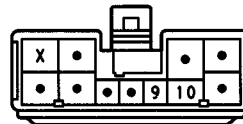

J 4 BLACK

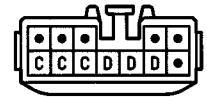

(HINT:SEE PAGE 7)

J 7 GRAY

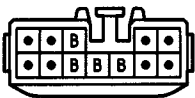

(HINT:SEE PAGE 7)

J11

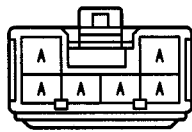

(HINT:SEE PAGE 7)

P 1 GRAY

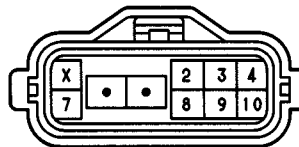

T 9 Ⓟ BLUE

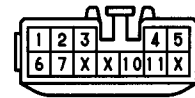

T10 Ⓟ BLUE

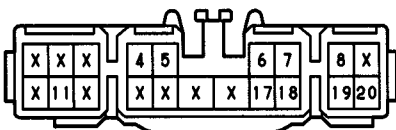

T11 GRAY

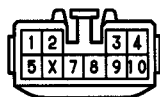

# POWER TILT AND POWER TELESCOPIC

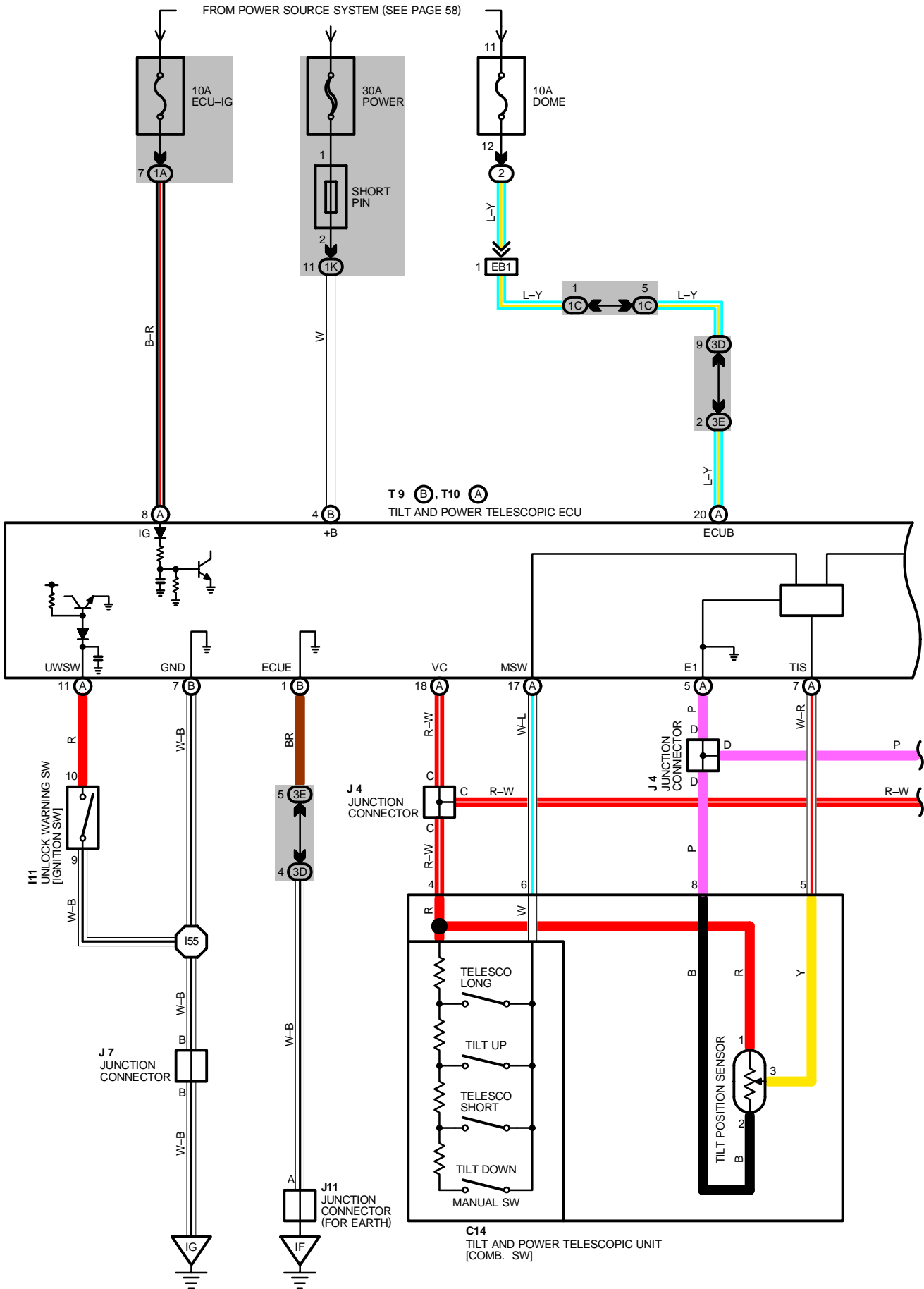



FROM POWER SOURCE SYSTEM (SEE PAGE 58)

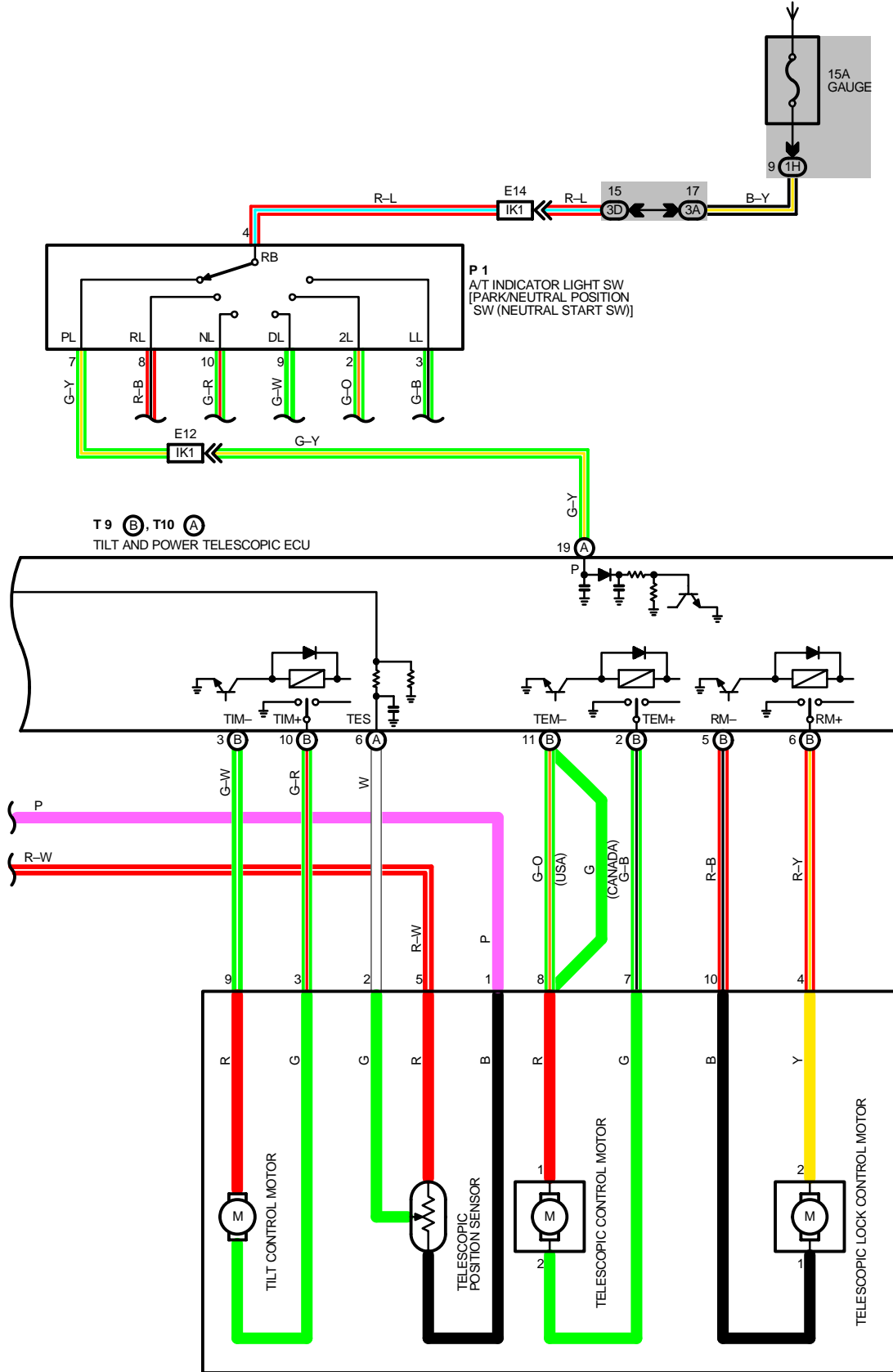

T11  
TILT AND POWER TELESCOPIC SENSOR AND MOTOR

# POWER TILT AND POWER TELESCOPIC

## SYSTEM OUTLINE

THIS SYSTEM OPERATES WITH BOTH THE TILT FUNCTION AND TELESCOPIC FUNCTION DRIVEN AUTOMATICALLY BY THE MOTOR AND CONTROLLED BY THE ECU. THE STEERING CAN BE ADJUSTED STEPLESSLY FORWARD AND BACK, AND UP AND DOWN, TO PROVIDE THE MOST SUITABLE STEERING POSITION FOR EASY DRIVING, WITH AUTOMATIC MOVEMENT OF THE STEERING TO A POSITION WHICH FACILITATES GETTING IN AND OUT OF THE VEHICLE.

CURRENT IS ALWAYS APPLIED THROUGH THE **POWER FUSE** TO **TERMINAL +B** OF THE TILT AND POWER TELESCOPIC ECU AND THROUGH THE **DOME FUSE** TO **TERMINAL ECU-B** OF THE TILT AND POWER TELESCOPIC ECU.

WITH THE IGNITION SW TURNED ON, THE CURRENT FLOWS FROM **ECU-IG** FUSE TO **TERMINAL IG** OF THE TILT AND POWER TELESCOPIC ECU.

### 1. MANUAL TILT OPERATION

WHEN THE IGNITION KEY IS INSERTED INTO THE IGNITION KEY CYLINDER (UNLOCK WARNING SW ON), A SIGNAL IS INPUT TO **TERMINAL UWSW** OF THE TILT AND POWER TELESCOPIC ECU. IF THE MANUAL SW IS PUSHED TO THE "TILT UP" SIDE, CURRENT FLOWS FROM **TERMINAL VC** OF THE TILT AND POWER TELESCOPIC ECU TO **TERMINAL MSW** OF THE TILT AND POWER TELESCOPIC ECU PASSING THROUGH THE MANUAL SW. (THE ECU DETECTS THE MANUAL SW POSITION BY THE VOLUME OF CURRENT.)

AS A RESULT, TILT AND POWER TELESCOPIC ECU OPERATES AND THE CURRENT TO **TERMINAL +B** OF THE ECU FLOWS FROM **TERMINAL TIM+** → **TERMINAL 3** OF TILT CONTROL MOTOR → **TERMINAL 9** → **TERMINAL TIM-** OF THE TILT AND POWER TELESCOPIC ECU → **TERMINAL GND** → **GROUND**, AND THE TILT UP FUNCTION OPERATES AS LONG AS THE MANUAL SW IS PUSHED TO THE "TILT UP" SIDE.

FOR TILT DOWN OPERATION, WHEN THE MANUAL SW IS PUSHED TO THE "TILT DOWN" SIDE, THE CURRENT FLOWING FROM ECU TO MOTOR FLOWS TO **TERMINAL TIM-** OF THE TILT AND POWER TELESCOPIC ECU → **TERMINAL 9** OF TILT CONTROL MOTOR → **TERMINAL 3** → **TERMINAL TIM+** OF THE TILT AND POWER TELESCOPIC ECU, SO THE MOTOR ROTATES IN THE REVERSE DIRECTION TO TILT UP OPERATION, AND TILT DOWN OPERATION OCCURS ONLY WHILE THE MANUAL SW IS BEING PUSHED.

### 2. MANUAL TELESCOPIC OPERATION

WHEN THE IGNITION KEY IS INSERTED IN THE IGNITION KEY CYLINDER (UNLOCK WARNING SW ON), THE SIGNAL FOR THIS IS INPUT TO **TERMINAL UWSW** OF THE TILT AND POWER TELESCOPIC ECU (HEREAFTER TILT AND POWER TELESCOPIC ECU) TELESCO SHORT. WHEN THE MANUAL SW IS MOVED TO THE "TELESCO SHORT" SIDE, CURRENT FLOWS FROM **TERMINAL VC** OF THE TILT AND POWER TELESCOPIC ECU, THROUGH THE MANUAL SW TO **TERMINAL MSW** OF THE TILT AND POWER TELESCOPIC ECU, THIS CAUSES THE TILT AND POWER TELESCOPIC ECU TO OPERATE, SENDING CURRENT FROM **TERMINAL +B** TO **TERMINAL RM+** → **TERMINAL 2** OF TELESCOPIC LOCK CONTROL MOTOR → **TERMINAL 1** → **TERMINAL RM-** OF TILT AND POWER TELESCOPIC ECU → **TERMINAL GND** → **GROUND**, RELEASING THE TELESCOPIC LOCK, CURRENT TO OPERATE THE TELESCOPIC UNIT THEN FLOWS FROM **TERMINAL TEM+** OF THE TILT AND POWER TELESCOPIC ECU → **TERMINAL 2** OF THE TELESCOPIC CONTROL MOTOR → **TERMINAL 1** → **TERMINAL TEM-** OF TILT AND POWER TELESCOPIC ECU → **TERMINAL GND** → **GROUND**, SO THE TELESCOPIC UNIT CHANGES FROM EXTENDED POSITION TO SHORT POSITION. WHEN THE TELESCOPIC MOVEMENT ENDS, CURRENT FLOWS FROM **TERMINAL RM-** OF THE TILT AND POWER TELESCOPIC ECU TO **TERMINAL 1** OF THE TELESCOPIC LOCK CONTROL MOTOR → **TERMINAL 2** → **TERMINAL RM+** OF TILT AND POWER TELESCOPIC ECU → **TERMINAL GND** → **GROUND**, ACTIVATING THE TELESCOPIC LOCK CONTROL MOTOR TO LOCK THE TELESCOPIC UNIT.

WHEN THE MANUAL SW IS MOVED TO THE "TELESCO LONG" POSITION, THE TILT AND POWER TELESCOPIC ECU ACTIVATE THE TELESCOPIC LOCK CONTROL MOTOR TO RELEASE THE TELESCOPIC LOCK THE SAME WAY AS FOR TELESCO SHORT OPERATION ABOVE. THEN CURRENT FLOWS FROM **TERMINAL TEM-** OF THE TILT AND POWER TELESCOPIC ECU TO **TERMINAL 1** OF TELESCOPIC CONTROL MOTOR → **TERMINAL 2** → **TERMINAL TEM+** OF TILT AND POWER TELESCOPIC ECU → **TERMINAL GND** → **GROUND**. AS A RESULT, THE TELESCOPIC CONTROL MOTOR ROTATES IN THE OPPOSITE DIRECTION TO TELESCOPIC SHORT OPERATION, AND THE TELESCOPIC UNIT EXTENDS. WHEN THE TELESCOPIC MOVEMENT ENDS, THE TILT AND POWER TELESCOPIC ECU ACTIVATES THE TELESCOPIC LOCK CONTROL MOTOR TO LOCK THE TELESCOPIC UNIT, THE SAME AS IN TELESCOPIC SHORT OPERATION.

### 3. AWAY OPERATION

IF THE IGNITION KEY IS REMOVED FROM THE IGNITION KEY CYLINDER (UNLOCK WARNING SW OFF) AT THIS TIME, A SIGNAL IS INPUT FROM **TERMINAL UWSW** OF THE TILT AND POWER TELESCOPIC ECU. ALSO, THE TILT POSITION SENSOR (COMB. SW) INPUTS INTO **TERMINAL TIS** OF THE TILT AND TELESCOPIC ECU A SIGNAL OF THE STEERING TILT POSITION JUST BEFORE THE IGNITION SW (FOR UNLOCK WARNING) IS TURNED FROM ON TO OFF.

AS A RESULT, THE TILT AND POWER TELESCOPIC ECU OPERATES AND THE CURRENT TO **TERMINAL +B** OF THE TILT AND POWER TELESCOPIC FLOWS FROM **TERMINAL TIM+** OF THE TILT AND POWER TELESCOPIC ECU → **TERMINAL 3** OF TILT CONTROL MOTOR → **TERMINAL 9** → **TERMINAL TIM-** OF THE TILT AND POWER TELESCOPIC ECU → **TERMINAL GND** → **GROUND**, CAUSING THE MOTOR TO ROTATE SO THAT TILT-UP OPERATION OCCURS AUTOMATICALLY.

AT THE SAME TIME, THE CURRENT FROM **TERMINAL +B** OF THE TILT AND POWER TELESCOPIC ECU TO **TERMINAL TEM+** FLOWS FROM **TERMINAL 7** OF TILT AND POWER TELESCOPIC SENSOR AND MOTOR → **TERMINAL 2** OF TELESCOPIC CONTROL MOTOR → **TERMINAL 1** → **TERMINAL 8** OF TILT AND POWER TELESCOPIC SENSOR AND MOTOR → **TERMINAL TEM-** OF THE TILT AND POWER TELESCOPIC ECU → **TERMINAL GND** → **GROUND**, CAUSING THE MOTOR TO ROTATE SO THAT TELESCOPIC SHORT OPERATION OCCURS ON AUTO AND WITH TILT UP OPERATION OCCURRING SIMULTANEOUSLY ON AUTO, AUTO AWAY OPERATION OCCURS.

#### 4. RETURN OPERATION

WHEN THE STEERING IS IN AUTO AWAY CONDITION AND THE IGNITION KEY IS INSERTED INTO THE IGNITION KEY CYLINDER (UNLOCK WARNING SW ON), A SIGNAL IS INPUT TO **TERMINAL UWSW** OF THE TILT AND POWER TELESCOPIC ECU.

AS A RESULT, THE TILT AND POWER TELESCOPIC ECU OPERATES AND THE CURRENT TO **TERMINAL +B** OF THE TILT AND POWER TELESCOPIC ECU FLOWS FROM **TERMINAL TEM-** OF THE TILT AND POWER TELESCOPIC ECU → **TERMINAL 8** OF TILT AND POWER TELESCOPIC SENSOR AND MOTOR → **TERMINAL 1** OF THE TELESCOPIC CONTROL MOTOR → **TERMINAL 2** → **TERMINAL 7** OF TILT AND POWER TELESCOPIC SENSOR AND MOTOR → **TERMINAL TEM+** OF THE TILT AND POWER TELESCOPIC ECU → **TERMINAL GND** → **GROUND**, AND AT THE SAME TIME, CURRENT FLOWS FROM **TERMINAL TIM-** OF THE TILT AND POWER TELESCOPIC ECU → **TERMINAL 9** OF TILT CONTROL MOTOR → **TERMINAL 3** → **TERMINAL TIM+** OF THE TILT AND POWER TELESCOPIC ECU → **TERMINAL GND** → **GROUND**, CAUSING BOTH THE TILT CONTROL MOTOR AND TELESCOPIC CONTROL MOTOR TO ROTATE. THE MOTORS CONTINUE TO ROTATE UNTIL THE SIGNALS INPUT FROM THE TILT POSITION SENSOR TO **TERMINAL TIS** OF THE TILT AND POWER TELESCOPIC ECU AND FROM THE TELESCOPIC POSITION SENSOR TO **TERMINAL TES** OF THE TILT AND POWER TELESCOPIC ECU (SIGNALS INFORMING THE ECU OF THE CURRENT POSITION OF THE STEERING) MATCH THE POSITION MEMORIZED BY THE ECU PRIOR TO AUTO AWAY OPERATION.

IN THIS WAY, THE STEERING POSITION IS AUTOMATICALLY RETURNED TO THE ORIGINAL POSITION.

WHEN THE IGNITION SW IS TURNED FROM OFF TO ON AND THE SHIFT LEVER IS SHIFTED TO A POSITION OTHER THAN "P" AUTO OPERATION IS STOPPED.

#### SERVICE HINTS

##### C14 TILT AND POWER TELESCOPIC UNIT [COMB. SW]

- 4-6 : APPROX. **160** WITH TELESCOPIC LONG OPERATION
- : APPROX. **360** WITH TILT UP OPERATION
- : APPROX. **790** WITH TELESCOPIC SHORT OPERATION
- : APPROX. **1990** WITH TILT DOWN OPERATION
- 7-8 : CONTINUITY WITH AUTO SW OFF
- 7-4 : **4-6 K**

##### T 11 TILT AND POWER TELESCOPIC SENSOR AND MOTOR

- 5-1 : **4-6 K**

##### I11 UNLOCK WARNING SW [IGNITION SW]

- 10-9: CLOSED WITH IGNITION KEY IN KEY CYLINDER

##### P 1 A/T INDICATOR LIGHT SW [PARK/NEUTRAL POSITION SW (NEUTRAL START SW)]

- 4-7 : CLOSED WITH SHIFT LEVER AT P POSITION

##### T 9(B), T10(A) TILT AND POWER TELESCOPIC ECU

- (A)** 4-GROUND : ALWAYS **10-14** VOLTS
- (A)** 8-GROUND : **10-14** VOLTS WITH IGNITION SW ON
- (A)** 20-GROUND : ALWAYS **10-14** VOLTS
- (A)** 19-GROUND : **10-14** VOLTS WITH IGNITION SW ON AND SHIFT LEVER AT P POSITION
- (A)** 11-GROUND : CONTINUITY WITH IGNITION KEY IN KEY CYLINDER
- (B)** 7-GROUND : ALWAYS BELOW **1** VOLTS
- (B)** 1-GROUND : ALWAYS BELOW **1** VOLTS
- (B)** 10-GROUND : **10-14** VOLTS WITH UNLOCK WARNING SW ON AND TILT UP OPERATION
- (B)** 3-GROUND : **10-14** VOLTS WITH UNLOCK WARNING SW ON AND TILT DOWN OPERATION
- (B)** 2-GROUND : **10-14** VOLTS WITH UNLOCK WARNING SW ON AND TELESCOPIC SHORT OPERATION
- (B)** 11-GROUND : **10-14** VOLTS WITH UNLOCK WARNING SW ON AND TELESCOPIC LONG OPERATION

# SHIFT LOCK

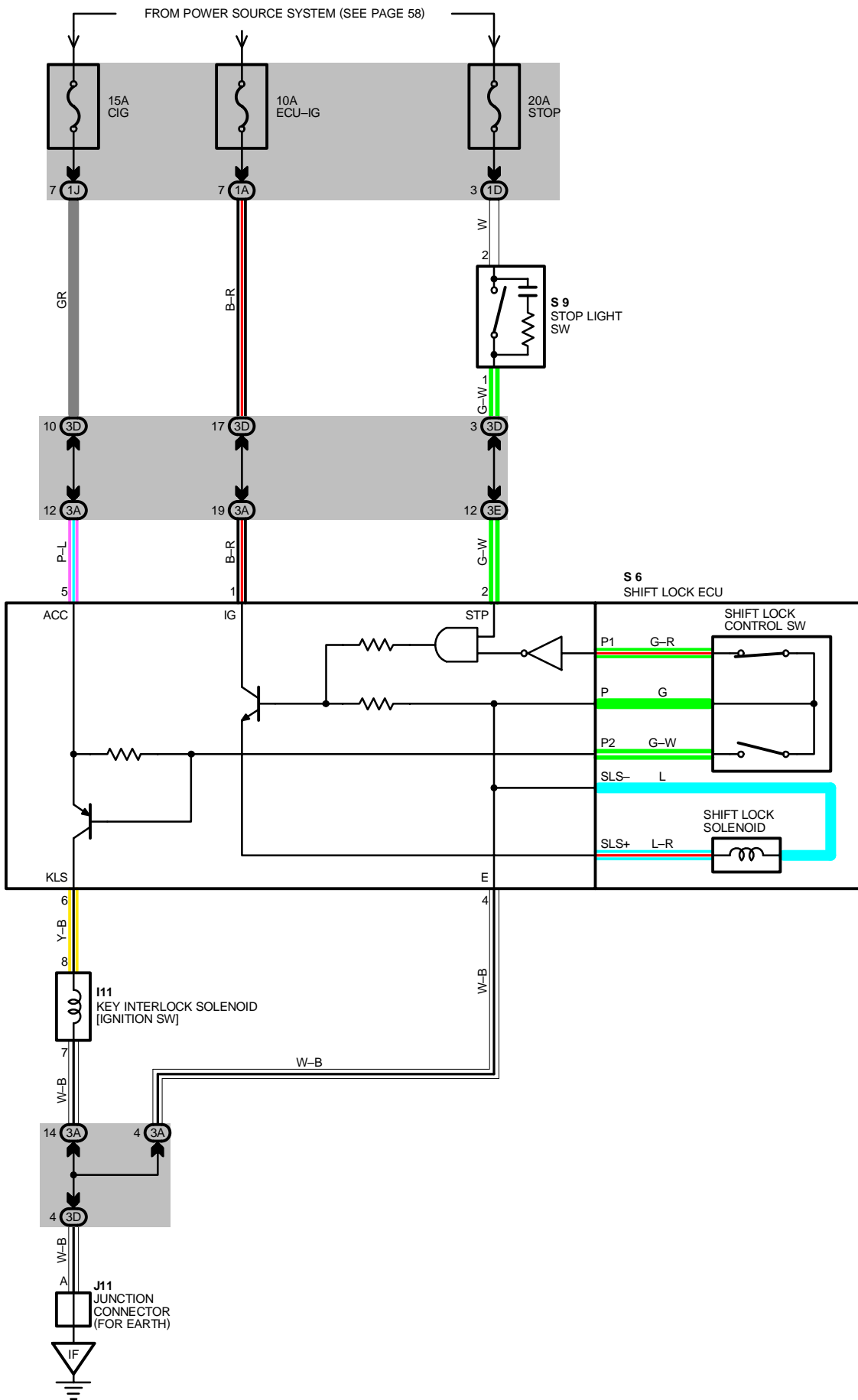

## SYSTEM OUTLINE

WHEN THE IGNITION SW IS TURNED TO **ACC** POSITION THE CURRENT FROM THE **CIG** FUSE FLOWS TO **TERMINAL 5** OF THE SHIFT LOCK ECU, IN THE ON POSITION, THE CURRENT FROM THE **ECU-IG** FUSE FLOWS TO **TERMINAL 1** OF THE ECU.

### 1. SHIFT LOCK MECHANISM

WITH THE IGNITION SW ON, WHEN A SIGNAL THAT THE BRAKE PEDAL IS DEPRESSED (STOP LIGHT SW ON) AND A SIGNAL THAT THE SHIFT LEVER IS PUT IN **P** POSITION (CONTINUITY BETWEEN P1 AND P OF THE SHIFT LOCK CONTROL SW) IS INPUT TO THE ECU, THE ECU OPERATES AND CURRENT FLOWS FROM **TERMINAL 1** OF THE ECU → **TERMINAL SLS+** OF THE SHIFT LOCK SOLENOID → SOLENOID → **TERMINAL SLS-** → **TERMINAL 4** OF THE ECU → **GROUND**. THIS CAUSES THE SHIFT LOCK SOLENOID TO TURN ON (PLATE STOPPER DISENGAGES) AND THE SHIFT LEVER CAN SHIFT INTO POSITION OTHER THAN THE **P**.

### 2. KEY INTERLOCK MECHANISM

WITH THE IGNITION SW **ON** OR **ACC** POSITION, WHEN THE SHIFT LEVER IS PUT IN **P** POSITION (NO CONTINUITY BETWEEN P2 AND P OF SHIFT LOCK CONTROL SW), THE CURRENT FLOWING FROM **TERMINAL 6** OF THE ECU → KEY INTERLOCK SOLENOID IS CUT OFF. THIS CAUSES THE KEY INTER LOCK SOLENOID TO TURN OFF (LOCK LEVER DISENGAGES FROM **LOCK** POSITION) AND THE IGNITION KEY CAN BE TURNED FROM **ACC** TO **LOCK** POSITION.

## SERVICE HINTS

### S 6 SHIFT LOCK ECU

5-GROUND : APPROX. 12 VOLTS WITH IGNITION SW AT **ACC** OR **ON** POSITION

1-GROUND : APPROX. 12 VOLTS WITH IGNITION SW AT **ON** POSITION

4-GROUND : ALWAYS CONTINUITY

2-GROUND : APPROX. 12 VOLTS WITH BRAKE PEDAL DEPRESSED

### S 9 STOP LIGHT SW

2-1 : CLOSED WITH BRAKE PEDAL DEPRESSED

## ○ : PARTS LOCATION

CODE	SEE PAGE	CODE	SEE PAGE	CODE	SEE PAGE
I11	29	S 6	29		
J11	29	S 9	29		

## ○ : JUNCTION BLOCK AND WIRE HARNESS CONNECTOR

CODE	SEE PAGE	JUNCTION BLOCK AND WIRE HARNESS (CONNECTOR LOCATION)
1A	20	COWL WIRE AND J/B NO. 1 (LEFT KICK PANEL)
1D		
1J		
3A	22	COWL WIRE AND J/B NO. 3 (BEHIND THE INSTRUMENT PANEL CENTER)
3D		
3E		

## ▽ : GROUND POINTS

CODE	SEE PAGE	GROUND POINTS LOCATION
IF	36	BEHIND COMBINATION METER

I11 BLACK

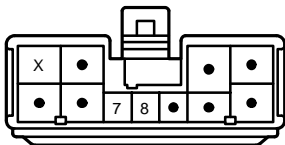

J11

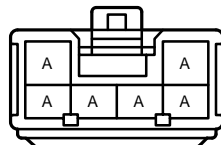

(HINT : SEE PAGE 7)

S 6

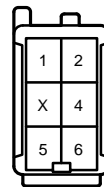

S 9

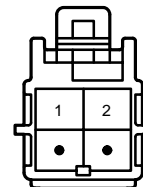

# MOON ROOF

FROM POWER SOURCE SYSTEM (SEE PAGE 58)

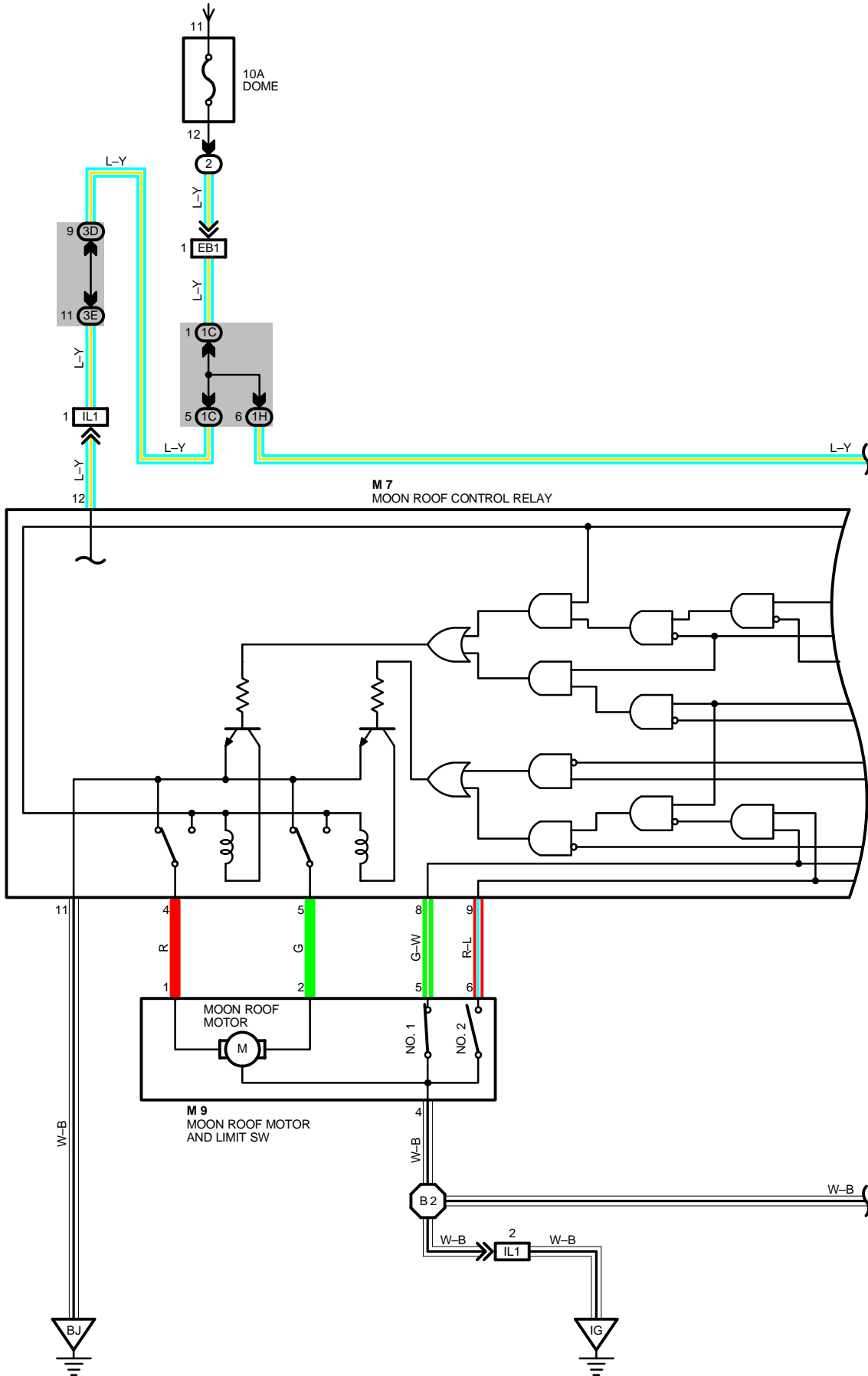

FROM POWER SOURCE SYSTEM (SEE PAGE 58)

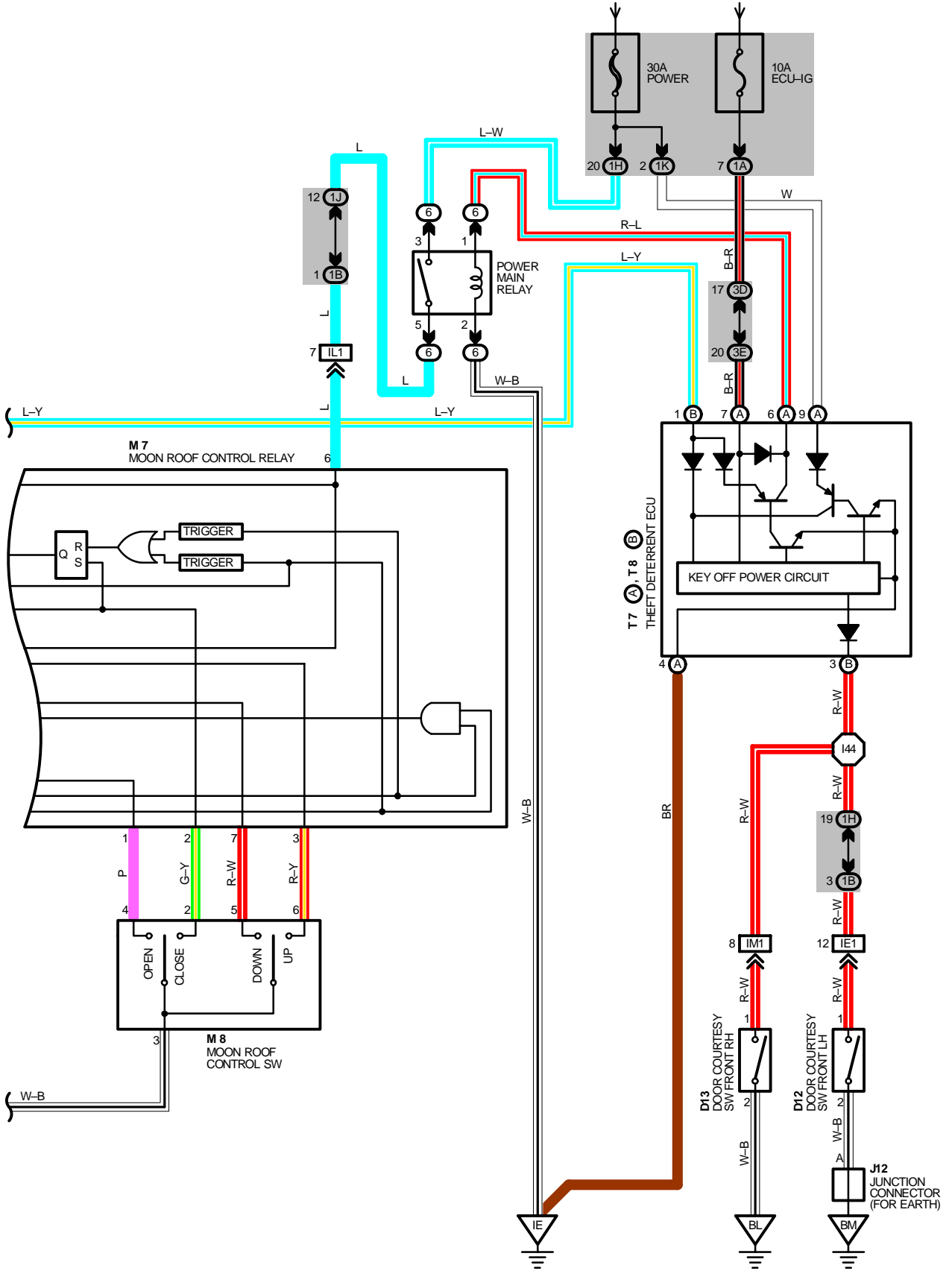

# MOON ROOF

## SYSTEM OUTLINE

CURRENT IS APPLIED AT ALL TIMES THROUGH **POWER FUSE** TO **TERMINAL 3** OF POWER MAIN RELAY AND ALSO THROUGH **DOVE FUSE** TO **TERMINAL 12** OF MOON ROOF CONTROL RELAY. WITH THE IGNITION SW TURNED ON, CURRENT FLOWS THROUGH THE **ECU-IG FUSE** → **TERMINAL (A)7** OF THE THEFT DETERRENT ECU → **TERMINAL (A)6** → **TERMINAL 1** OF THE POWER MAIN RELAY → **TERMINAL 2** → TO **GROUND**. AS A RESULT, POWER MAIN RELAY IS ACTIVATED AND THE CURRENT TO **TERMINAL 3** OF POWER MAIN RELAY FLOWS FROM **TERMINAL 5** OF RELAY TO **TERMINAL 6** OF MOON ROOF CONTROL RELAY.

### 1. SLIDE OPEN OPERATION

WHEN THE IGNITION SW IS TURNED ON AND THE MOON ROOF CONTROL SW IS PUSHED TO THE **OPEN** POSITION, A SIGNAL IS INPUT FROM **TERMINAL 4** OF MOON ROOF CONTROL SW TO **TERMINAL 1** OF MOON ROOF CONTROL RELAY. MOON ROOF LIMIT SW NO.1 OR NO.2 IS ON AT THIS TIME.

WHEN THIS OCCURS, THE RELAY IS ACTIVATED AND THE CURRENT TO **TERMINAL 6** OF MOON ROOF CONTROL RELAY FLOWS FROM **TERMINAL 5** → **TERMINAL 2** OF MOON ROOF MOTOR → **TERMINAL 1** → **TERMINAL 4** OF MOON ROOF CONTROL RELAY → **TERMINAL 11** → TO **GROUND** AND ROTATES THE MOTOR TO OPEN THE MOON ROOF WHILE THE SW IS BEING PUSHED TO **OPEN** POSITION.

### 2. SLIDE CLOSE OPERATION

WITH THE IGNITION SW TURNED ON, THE MOON ROOF COMPLETELY OPEN AND MOON ROOF LIMIT SW NO.1 AND NO.2 BOTH ON, WHEN THE MOON ROOF CONTROL SW IS PUSHED TO THE **CLOSE** POSITION A SIGNAL IS INPUT FROM **TERMINAL 2** OF MOON ROOF CONTROL SW TO **TERMINAL 2** OF MOON ROOF CONTROL RELAY.

WHEN THIS OCCURS, THE RELAY IS ACTIVATED AND THE CURRENT TO **TERMINAL 6** OF MOON ROOF CONTROL RELAY FLOWS FROM **TERMINAL 4** → **TERMINAL 1** OF MOON ROOF MOTOR → **TERMINAL 2** → **TERMINAL 5** OF MOON ROOF CONTROL RELAY → **TERMINAL 11** → TO **GROUND** AND ROTATES THE MOTOR TO CLOSE THE MOON ROOF WHILE THE SW IS BEING PUSHED TO **CLOSE** POSITION.

MOON ROOF LIMIT SW NO.1 TURNS OFF (LIMIT SW NO.2 IS ON) AND AT **200 MM (7.9 IN)** BEFORE FULLY **CLOSED** POSITION, SIGNAL IS INPUT FROM **TERMINAL 5** OF LIMIT SW NO.1 TO **TERMINAL 8** OF MOON ROOF CONTROL RELAY. THIS SIGNAL ACTIVATES THE RELAY AND STOPS CONTINUITY FROM **TERMINAL 6** OF MOON ROOF CONTROL RELAY TO **TERMINAL 11**. AS A RELAY, THE MOON ROOF STOPS AT THIS POSITION.

TO CLOSE THE MOON ROOF COMPLETELY, PUSHING THE MOON ROOF CONTROL SW AGAIN TO THE CLOSE SIDE CAUSES A SIGNAL TO BE INPUT AGAIN TO **TERMINAL 2** OF MOON ROOF CONTROL RELAY. THIS ACTIVATES THE RELAY AND THE MOON ROOF WILL CLOSE AS LONG AS THE MOON ROOF CONTROL SW IS BEING PUSHED, ALLOWING THE MOON ROOF TO FULLY CLOSE.

### 3. TILT UP OPERATION

WHEN THE MOON ROOF CONTROL SW IS PUSHED TO **TILT UP** POSITION, WITH THE IGNITION SW TURNED ON AND THE MOON ROOF COMPLETELY CLOSED (MOON ROOF LIMIT SW NO.2 IS OFF), A SIGNAL IS INPUT FROM **TERMINAL 6** OF MOON ROOF CONTROL SW TO **TERMINAL 3** OF MOON ROOF CONTROL RELAY. AS A RESULT, THE RELAY IS ACTIVATED AND THE CURRENT TO **TERMINAL 6** OF RELAY FLOWS FROM **TERMINAL 4** OF RELAY → **TERMINAL 1** OF MOON ROOF MOTOR → **TERMINAL 2** → **TERMINAL 5** OF RELAY → **TERMINAL 11** TO **GROUND** AND ROTATES THE MOTOR SO THAT TILT UP OPERATION OCCURS AS LONG AS THE MOON ROOF CONTROL SW IS PUSHED ON THE TILT UP SIDE.

### 4. TILT DOWN OPERATION

WHEN THE MOON ROOF CONTROL SW IS PUSHED TO **TILT DOWN** POSITION, WITH THE IGNITION SW TURNED ON AND THE MOON ROOF TILTED UP (NO.1 AND NO.2 MOON ROOF LIMIT SWITCHES ARE BOTH OFF), A SIGNAL IS INPUT FROM **TERMINAL 5** OF MOON ROOF CONTROL SW TO **TERMINAL 7** OF MOON ROOF CONTROL RELAY.

AS A RESULT THE RELAY IS ACTIVATED AND THE CURRENT TO **TERMINAL 6** OF RELAY FLOWS FROM **TERMINAL 5** OF RELAY → **TERMINAL 2** OF MOON ROOF MOTOR → **TERMINAL 1** → **TERMINAL 4** OF RELAY → **TERMINAL 11** → TO **GROUND** AND ROTATES THE MOTOR SO THAT TILT DOWN OPERATION OCCURS AS LONG AS THE MOON ROOF CONTROL SW IS PUSHED ON THE TILT DOWN SIDE. (DURING TILT DOWN, LIMIT SW NO.1 IS CHANGED FROM OFF TO ON.)



## 5. KEY OFF MOON ROOF OPERATION

WITH THE IGNITION SW TURNED FROM ON TO OFF, THE THEFT DETERRENT ECU OPERATES AND CURRENT FLOWS FROM **POWER FUSE** TO **TERMINAL (A)9** OF THE ECU OR **DOME FUSE** TO **TERMINAL (B)1** OF THE ECU → **TERMINAL (A)6** → **TERMINAL 1** OF POWER MAIN RELAY → **TERMINAL 2** → TO **GROUND** FOR ABOUT **60** SECONDS. THE SAME AS NORMAL OPERATION, THE CURRENT FLOWS FROM **POWER FUSE** → **TERMINAL 3** OF THE POWER MAIN RELAY → **TERMINAL 5** → **TERMINAL 6** OF THE MOON ROOF CONTROL RELAY. AS A RESULT, FOR ABOUT **60** SECONDS AFTER THE IGNITION SW IS TURNED OFF, THE FUNCTIONING OF THIS RELAY MAKES IT POSSIBLE TO OPEN AND CLOSE THE MOON ROOF. ALSO, BY OPENING THE FRONT DOOR (DOOR COURTESY SW ON) WITHIN ABOUT **60** SECONDS AFTER TURNING THE IGNITION SW TO OFF, A SIGNAL IS INPUT TO **TERMINAL (B)3** OF THEFT DETERRENT ECU. AS A RESULT, THE ECU TURNS OFF AND OPEN AND CLOSE MOVEMENT OF THE MOON ROOF STOPS.

## SERVICE HINTS

### POWER MAIN RELAY

(6)3–(6)5 : CLOSED WITH IGNITION SW AT **ON** POSITION

### M 7 MOON ROOF CONTROL RELAY

11–GROUND : ALWAYS CONTINUITY

6–GROUND : APPROX. **12** VOLTS WITH IGNITION SW AT **ON** POSITION

4–GROUND : APPROX. **12** VOLTS WITH IGNITION SW ON, AND MOON ROOF CONTROL SW AT **CLOSE** OR **UP** POSITION  
(EXCEPT APPROX. **200 MM (7.9 IN)** BEFORE FULLY CLOSED POSITION)

5–GROUND : APPROX. **12** VOLTS WITH IGNITION SW ON, AND MOON ROOF CONTROL SW AT **OPEN** OR **DOWN** POSITION

### M 8 MOON ROOF CONTROL SW

6–3 : CLOSED WITH MOON ROOF CONTROL SW AT **UP** POSITION

2–3 : CLOSED WITH MOON ROOF CONTROL SW AT **CLOSE** POSITION

5–3 : CLOSED WITH MOON ROOF CONTROL SW AT **DOWN** POSITION

4–3 : CLOSED WITH MOON ROOF CONTROL SW AT **OPEN** POSITION

3–GROUND : ALWAYS CONTINUITY

## ○ : PARTS LOCATION

CODE	SEE PAGE	CODE	SEE PAGE	CODE	SEE PAGE
D12	30	M 7	31	T 7	A 29
D13	30	M 8	31	T 8	B 29
J12	30	M 9	31		

## ○ : RELAY BLOCKS

CODE	SEE PAGE	RELAY BLOCKS (RELAY BLOCK LOCATION)
2	19	R/B NO. 2 (ENGINE COMPARTMENT LEFT)
6	24	R/B NO. 6 (LEFT KICK PANEL)

## ○ : JUNCTION BLOCK AND WIRE HARNESS CONNECTOR

CODE	SEE PAGE	JUNCTION BLOCK AND WIRE HARNESS (CONNECTOR LOCATION)
1A	20	COWL WIRE AND J/B NO. 1 (LEFT KICK PANEL)
1B		
1C		
1H		
1J		
1K		
3D	22	COWL WIRE AND J/B NO. 3 (BEHIND THE INSTRUMENT PANEL CENTER)
3E		

# MOON ROOF

## ☐ : CONNECTOR JOINING WIRE HARNESS AND WIRE HARNESS

CODE	SEE PAGE	JOINING WIRE HARNESS AND WIRE HARNESS (CONNECTOR LOCATION)
EB1	34	COWL WIRE AND R/B NO. 2 WIRE (INSIDE OF R/B NO. 2)
IE1	36	COWL WIRE AND FLOOR NO. 2 WIRE (LEFT KICK PANEL)
IL1	38	COWL WIRE AND ROOF WIRE (BEHIND GLOVE BOX)
IM1	38	COWL WIRE AND FLOOR NO. 1 WIRE (RIGHT KICK PANEL)

## ▽ : GROUND POINTS

CODE	SEE PAGE	GROUND POINTS LOCATION
IE	36	LEFT KICK PANEL
IG	36	BEHIND GLOVE BOX
BJ	40	FRONT SIDE OF ROOF CENTER
BL	40	UNDER THE FRONT SEAT RH
BM	40	LUGGAGE ROOM LEFT

## ○ : SPLICE POINTS

CODE	SEE PAGE	WIRE HARNESS WITH SPLICE POINTS	CODE	SEE PAGE	WIRE HARNESS WITH SPLICE POINTS
I44	38	COWL WIRE	B 2	40	ROOF WIRE

D12, D13 BLACK

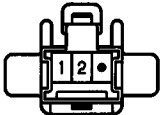

J12

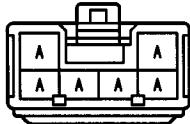

(HINT:SEE PAGE 7)

M 7

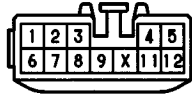

M 8

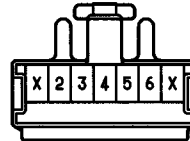

M 9

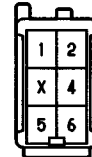

T 7 (A) ORANGE

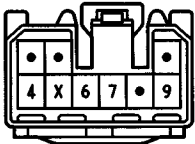

T 8 (B) ORANGE

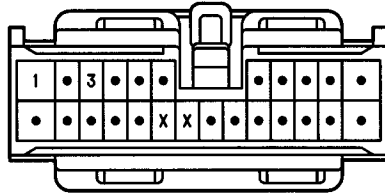

# UNLOCK AND SEAT BELT WARNING

B 6



C10 (B) ORANGE

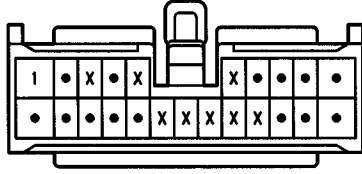

C11 (A) GRAY

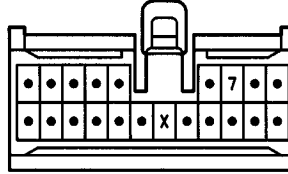

D12 BLACK

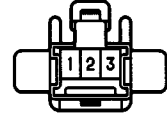

I11 BLACK

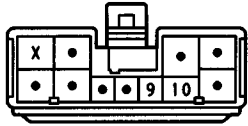

J 7 GRAY

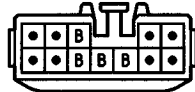

(HINT:SEE PAGE 7)

J12

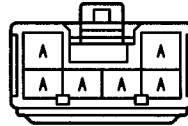

(HINT:SEE PAGE 7)

# UNLOCK AND SEAT BELT WARNING

FROM POWER SOURCE SYSTEM (SEE PAGE 58)

FROM POWER SOURCE SYSTEM (SEE PAGE 58)

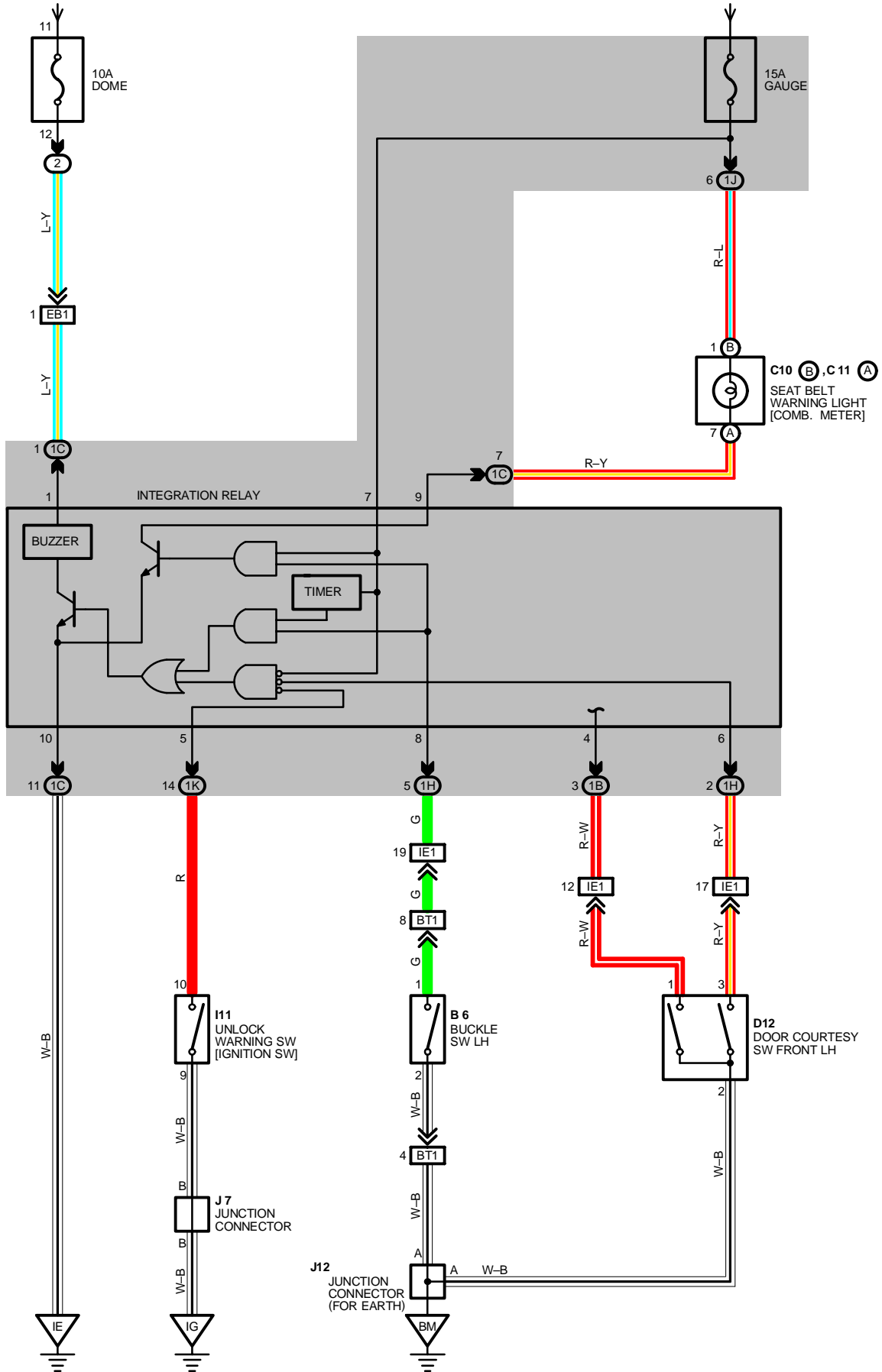

## SYSTEM OUTLINE

CURRENT ALWAYS FLOWS TO **TERMINAL 1** OF THE INTEGRATION RELAY THROUGH **DOME FUSE**.

### 1. SEAT BELT WARNING SYSTEM

WHEN THE IGNITION SW IS TURNED ON, CURRENT FLOWS FROM THE **GAUGE FUSE** TO **TERMINAL 7** OF THE INTEGRATION RELAY. AT THE SAME TIME, CURRENT FLOWS TO **TERMINAL 9** OF THE RELAY FROM THE **GAUGE FUSE** THROUGH THE SEAT BELT WARNING LIGHT. THIS CURRENT ACTIVATES THE INTEGRATION RELAY AND CURRENT FLOWING THROUGH THE WARNING LIGHT FLOWS FROM **TERMINAL 9** OF THE RELAY → **TERMINAL 10** → **GROUND**, CAUSING THE WARNING LIGHT TO LIGHT UP. A BUCKLE SW OFF SIGNAL IS INPUT TO **TERMINAL 8** OF THE RELAY, THE CURRENT FLOWING TO **TERMINAL 7** OF THE RELAY FLOWS FROM **TERMINAL 10** → **GROUND** AND THE SEAT BELT WARNING BUZZER SOUNDS FOR APPROX. **4-8 SECONDS**. HOWEVER, IF THE SEAT BELT IS PUT ON DURING THIS PERIOD (WHILE THE BUZZER IS SOUNDING), SIGNAL INPUT TO **TERMINAL 8** OF RELAY STOPS AND THE CURRENT FLOW FROM **TERMINAL 7** OF THE RELAY → **TERMINAL 10** → **GROUND** IS CUT, CAUSING THE BUZZER TO STOP.

### 2. UNLOCK WARNING SYSTEM

WITH THE IGNITION KEY INSERTED IN THE KEY CYLINDER (UNLOCK SW ON), THE IGNITION SW STILL OFF AND DRIVER'S DOOR OPEN (DOOR COURTESY SW ON), WHEN A SIGNAL IS INPUT TO **TERMINAL 6** OF THE RELAY, THE INTEGRATION RELAY OPERATES, CURRENT FLOWS FROM **TERMINAL 7** OF THE RELAY → **TERMINAL 10** → **GROUND** AND UNLOCK WARNING BUZZER SOUNDS.

## SERVICE HINTS

### B 6 BUCKLE SW LH

1-2 : CLOSED WITH DRIVER'S SEAT BELT IN USE

### D12 DOOR COURTESY SW FRONT LH

3-2 : CLOSED WITH LH DOOR OPEN

### I11 UNLOCK WARNING SW [IGNITION SW]

10-9: CLOSED WITH IGNITION KEY IN CYLINDER

### INTEGRATION RELAY

10-GROUND : ALWAYS CONTINUITY

6-GROUND : CONTINUITY WITH DRIVER'S DOOR OPEN

5-GROUND : CONTINUITY WITH IGNITION KEY IN CYLINDER

8-GROUND : CONTINUITY WITH DRIVER'S SEAT BELT IN USE

9-GROUND : 0 VOLTS WITH IGNITION SW ON AND BUCKLE SW OFF

1-GROUND : ALWAYS APPROX. 12 VOLTS

## ○ : PARTS LOCATION

CODE	SEE PAGE	CODE	SEE PAGE	CODE	SEE PAGE
<b>B 6</b>	<a href="#">32</a>	<b>D12</b>	<a href="#">30</a>	<b>J12</b>	<a href="#">30</a>
<b>C10</b>	B <a href="#">28</a>	<b>I11</b>	<a href="#">29</a>		
<b>C11</b>	A <a href="#">28</a>	<b>J 7</b>	<a href="#">29</a>		

## ○ : RELAY BLOCKS

CODE	SEE PAGE	RELAY BLOCKS (RELAY BLOCK LOCATION)
<b>2</b>	<a href="#">19</a>	R/B NO. 2 (ENGINE COMPARTMENT LEFT)

## ○ : JUNCTION BLOCK AND WIRE HARNESS CONNECTOR

CODE	SEE PAGE	JUNCTION BLOCK AND WIRE HARNESS (CONNECTOR LOCATION)
<b>1B</b>	<a href="#">20</a>	COWL WIRE AND J/B NO. 1 (LEFT KICK PANEL)
<b>1C</b>		
<b>1H</b>		
<b>1J</b>		
<b>1K</b>		

## □ : CONNECTOR JOINING WIRE HARNESS AND WIRE HARNESS

CODE	SEE PAGE	JOINING WIRE HARNESS AND WIRE HARNESS (CONNECTOR LOCATION)
<b>EB1</b>	<a href="#">34</a>	COWL WIRE AND R/B NO. 2 WIRE (INSIDE OF R/B NO. 2)
<b>IE1</b>	<a href="#">36</a>	COWL WIRE AND FLOOR NO. 2 WIRE (LEFT KICK PANEL)
<b>BT1</b>	<a href="#">42</a>	FLOOR NO. 2 WIRE AND FRONT SEAT LH WIRE (UNDER THE FRONT LH SEAT)

## ▽ : GROUND POINTS

CODE	SEE PAGE	GROUND POINTS LOCATION
<b>IE</b>	<a href="#">36</a>	LEFT KICK PANEL
<b>IG</b>	<a href="#">36</a>	BEHIND GLOVE BOX
<b>BM</b>	<a href="#">40</a>	LUGGAGE ROOM LEFT

# POWER SEAT

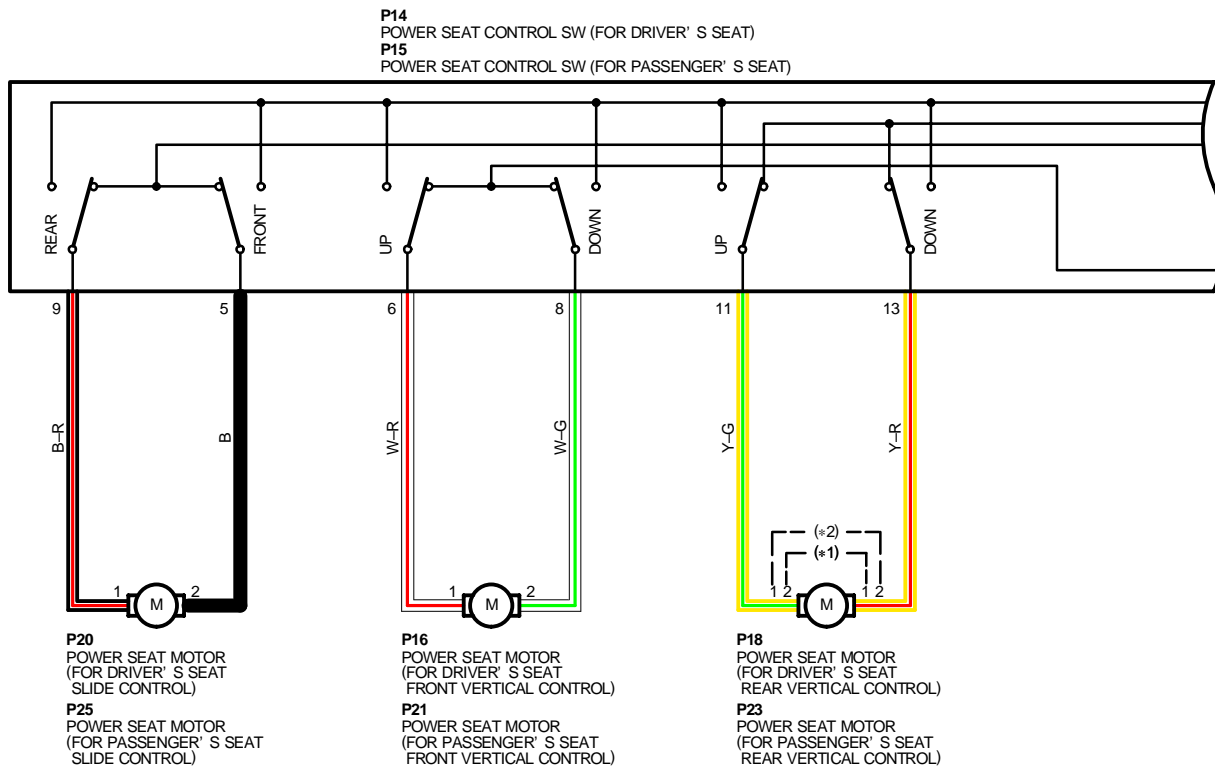

FROM POWER SOURCE SYSTEM (SEE PAGE 58)

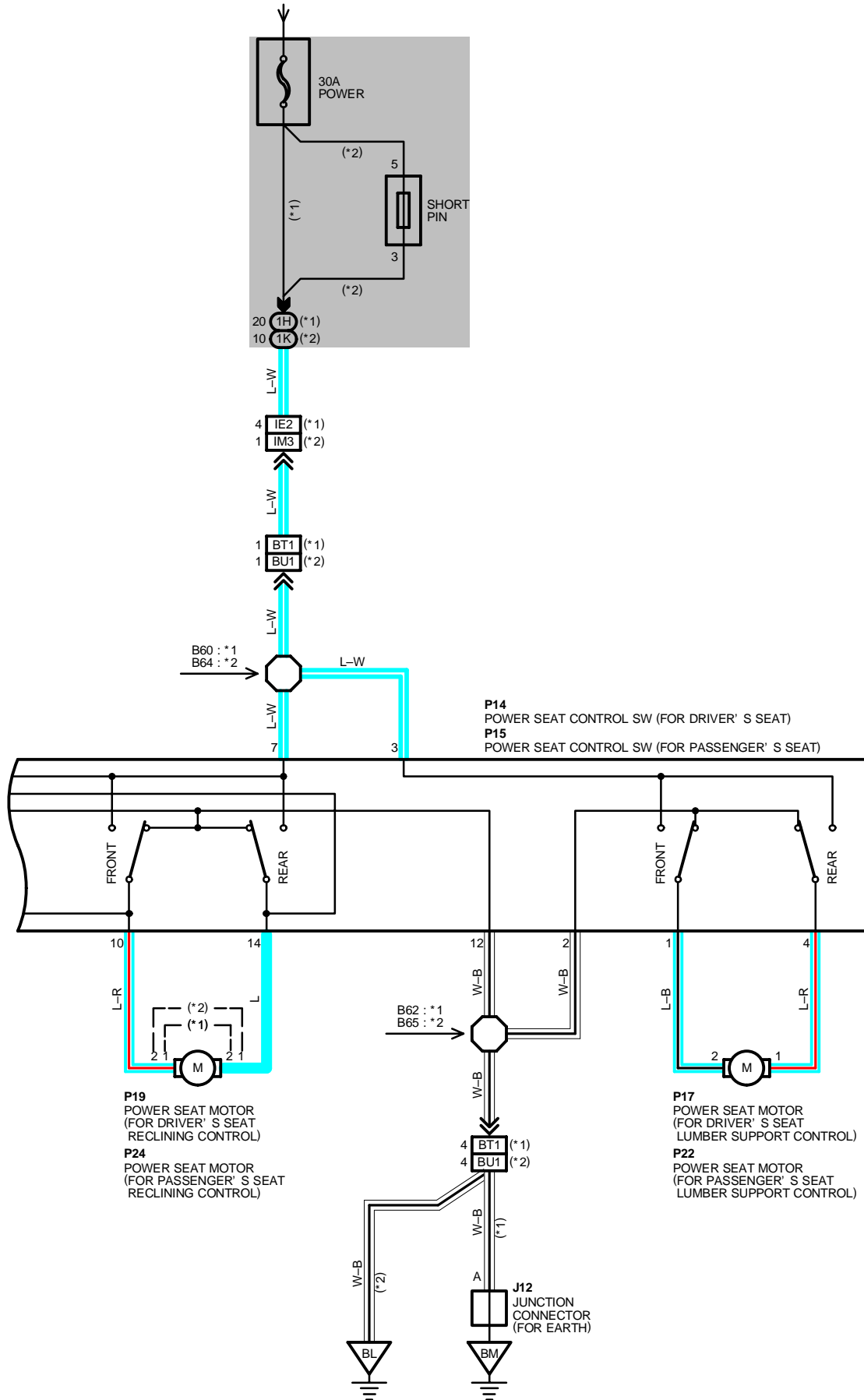

# POWER SEAT

## SERVICE HINTS

### P14 POWER SEAT CONTROL SW (FOR DRIVER'S SEAT)

- 3, 7-GROUND : ALWAYS APPROX. 12 VOLTS
- 2, 12-GROUND: ALWAYS CONTINUITY

### P15 POWER SEAT CONTROL SW (FOR PASSENGER'S SEAT)

- 3, 7-GROUND : ALWAYS APPROX. 12 VOLTS
- 2, 12-GROUND: ALWAYS CONTINUITY

## ○ : PARTS LOCATION

CODE	SEE PAGE	CODE	SEE PAGE	CODE	SEE PAGE
J12	30	P18	32	P23	32
P14	32	P19	32	R24	32
P15	32	P20	32	R25	32
P16	32	P21	32		
P17	32	P22	32		

## ○ : JUNCTION BLOCK AND WIRE HARNESS CONNECTOR

CODE	SEE PAGE	JUNCTION BLOCK AND WIRE HARNESS (CONNECTOR LOCATION)
1H	20	COWL WIRE AND J/B NO. 1 (LEFT KICK PANEL)
1K		

## □ : CONNECTOR JOINING WIRE HARNESS AND WIRE HARNESS

CODE	SEE PAGE	JOINING WIRE HARNESS AND WIRE HARNESS (CONNECTOR LOCATION)
IE2	36	COWL WIRE AND FLOOR NO. 2 WIRE (LEFT KICK PANEL)
IM3	38	COWL WIRE AND FLOOR NO. 1 WIRE (RIGHT KICK PANEL)
BT1	42	FLOOR NO. 2 WIRE AND FRONT SEAT LH WIRE (UNDER THE FRONT LH SEAT)
BU1	42	FLOOR NO. 1 WIRE AND FRONT SEAT RH WIRE (UNDER THE FRONT RH SEAT)

## ▽ : GROUND POINTS

CODE	SEE PAGE	GROUND POINTS LOCATION
BL	40	UNDER THE FRONT SEAT RH
BM	40	LUGGAGE ROOM LEFT

## ○ : SPLICE POINTS

CODE	SEE PAGE	WIRE HARNESS WITH SPLICE POINTS	CODE	SEE PAGE	WIRE HARNESS WITH SPLICE POINTS
B60	42	FRONT SEAT LH WIRE	B64	42	FRONT SEAT RH WIRE
B62			B65		

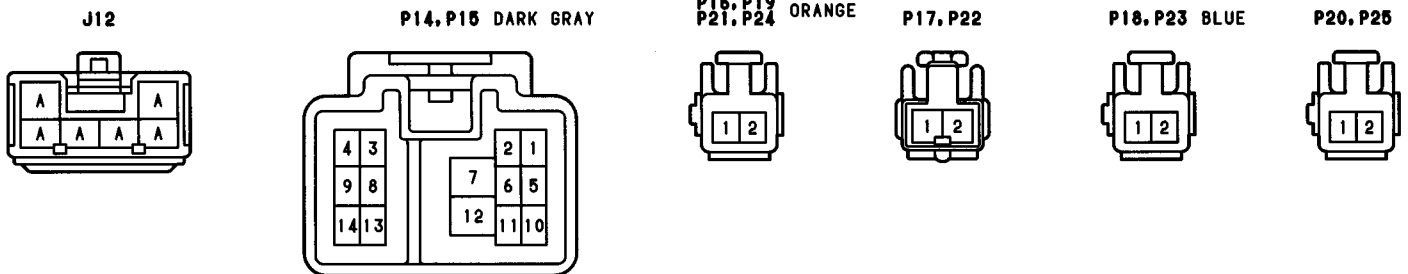



---

# SEAT HEATER

FROM POWER SOURCE SYSTEM (SEE PAGE 58)

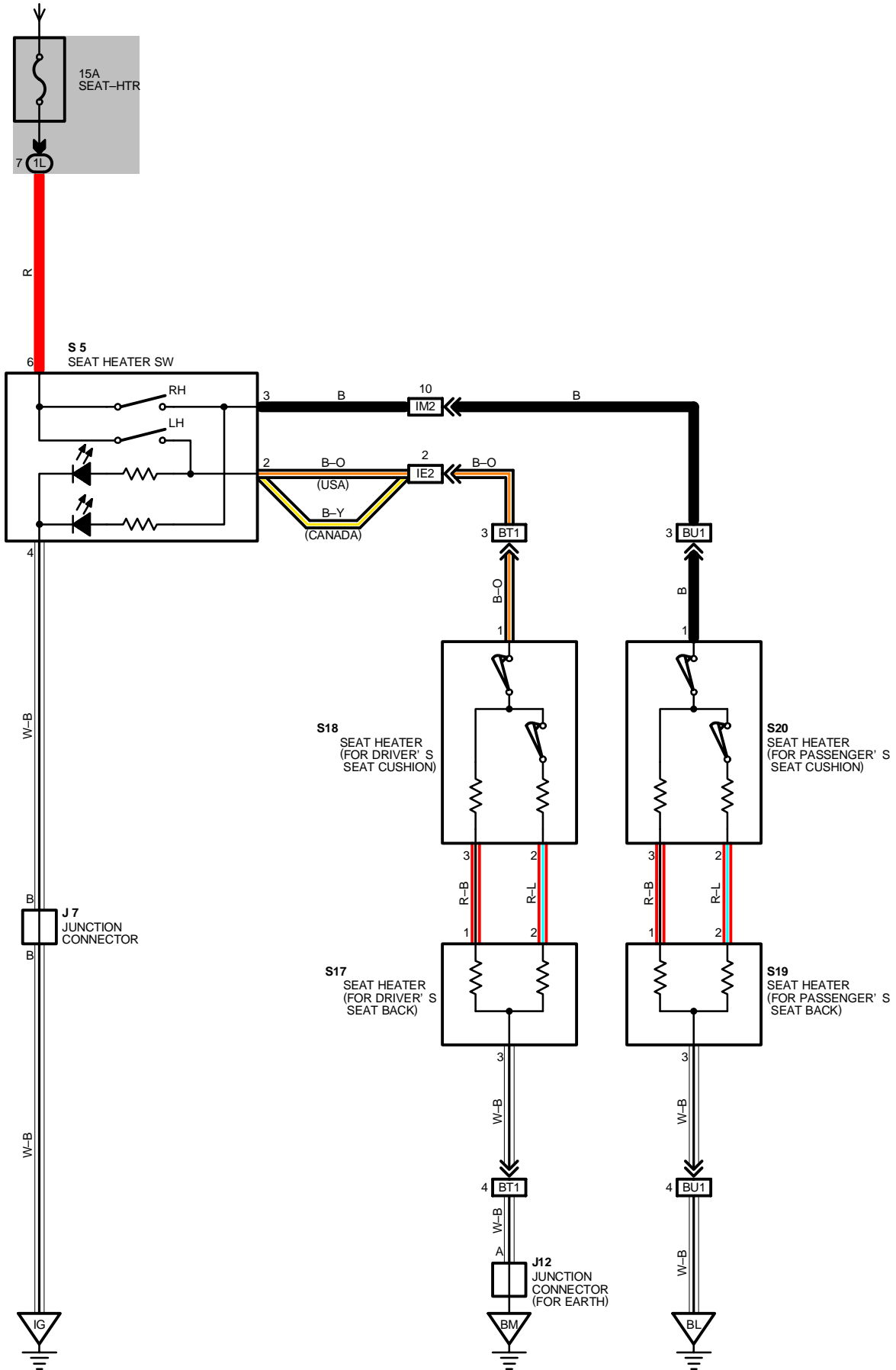

## SERVICE HINTS

### S 5 SEAT HEATER SW

6-GROUND : APPROX. 12 VOLTS WITH SW AT **ON** POSITION  
 4-GROUND : ALWAYS CONTINUITY

### ○ : PARTS LOCATION

CODE	SEE PAGE	CODE	SEE PAGE	CODE	SEE PAGE
J 7	29	S17	32	S20	32
J12	30	S18	32		
S 5	29	S19	32		

### ○ : JUNCTION BLOCK AND WIRE HARNESS CONNECTOR

CODE	SEE PAGE	JUNCTION BLOCK AND WIRE HARNESS (CONNECTOR LOCATION)
1L	20	COWL WIRE AND J/B NO. 1 (LEFT KICK PANEL)

### □ : CONNECTOR JOINING WIRE HARNESS AND WIRE HARNESS

CODE	SEE PAGE	JOINING WIRE HARNESS AND WIRE HARNESS (CONNECTOR LOCATION)
IE2	36	COWL WIRE AND FLOOR NO. 2 WIRE (LEFT KICK PANEL)
IM2	38	COWL WIRE AND FLOOR NO. 1 WIRE (RIGHT KICK PANEL)
BT1	42	FLOOR NO. 2 WIRE AND FRONT SEAT LH WIRE (UNDER THE FRONT LH SEAT)
BU1	42	FLOOR NO. 1 WIRE AND FRONT SEAT RH WIRE (UNDER THE FRONT RH SEAT)

### ▽ : GROUND POINTS

CODE	SEE PAGE	GROUND POINTS LOCATION
IG	36	BEHIND GLOVE BOX
BL	40	UNDER THE FRONT SEAT RH
BM	40	LUGGAGE ROOM LEFT

J 7 GRAY

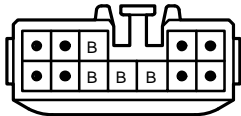

(HINT : SEE PAGE 7)

J12

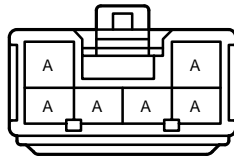

(HINT : SEE PAGE 7)

S 5

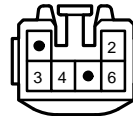

S17, S19

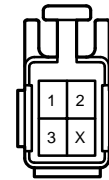

S18, S20 GRAY

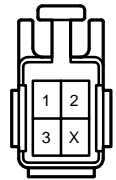

# ELECTRIC TENSION REDUCER

FROM POWER SOURCE SYSTEM (SEE PAGE 58)

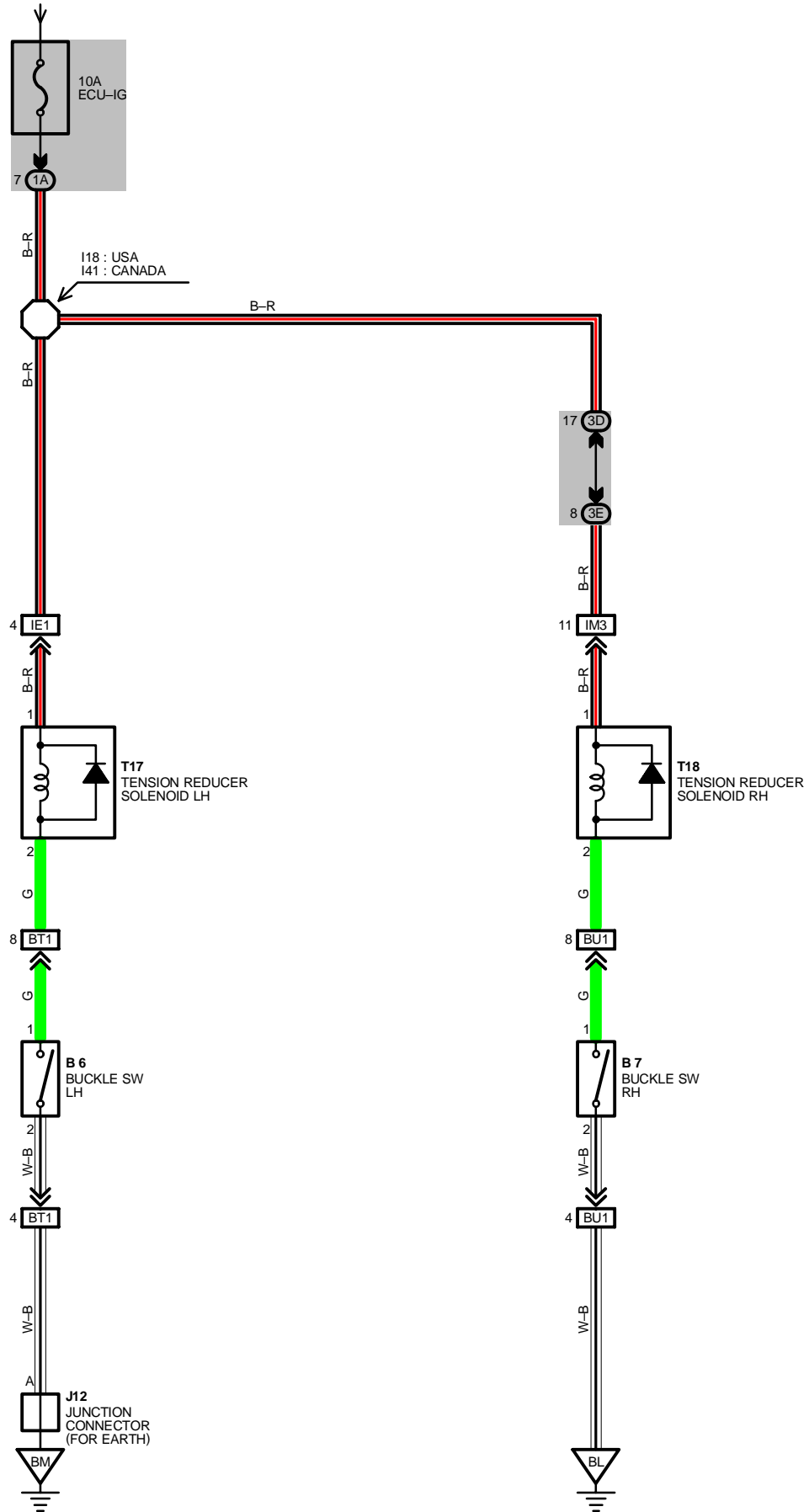

## SERVICE HINTS

### B 6 BUCKLE SW LH

1-2 : CLOSED WITH DRIVER'S SEAT BELT IN USE

### B 7 BUCKLE SW RH

1-2 : CLOSED WITH PASSENGER'S SEAT BELT IN USE

### T17, T18 TENSION REDUCER SOLENOID LH, RH

1-GROUND : APPROX. 12 VOLTS WITH IGNITION SW AT ON POSITION

## ○ : PARTS LOCATION

CODE	SEE PAGE	CODE	SEE PAGE	CODE	SEE PAGE
B 6	32	J12	30	T18	31
B 7	32	T17	31		

## ○ : JUNCTION BLOCK AND WIRE HARNESS CONNECTOR

CODE	SEE PAGE	JUNCTION BLOCK AND WIRE HARNESS (CONNECTOR LOCATION)
1A	20	COWL WIRE AND J/B NO. 1 (LEFT KICK PANEL)
3D	22	COWL WIRE AND J/B NO. 3 (BEHIND THE INSTRUMENT PANEL CENTER)
3E		

## □ : CONNECTOR JOINING WIRE HARNESS AND WIRE HARNESS

CODE	SEE PAGE	JOINING WIRE HARNESS AND WIRE HARNESS (CONNECTOR LOCATION)
IE1	36	COWL WIRE AND FLOOR NO. 2 WIRE (LEFT KICK PANEL)
IM3	38	COWL WIRE AND FLOOR NO. 1 WIRE (RIGHT KICK PANEL)
BT1	42	FLOOR NO. 2 WIRE AND FRONT SEAT LH WIRE (UNDER THE FRONT LH SEAT)
BU1	42	FLOOR NO. 1 WIRE AND FRONT SEAT RH WIRE (UNDER THE FRONT RH SEAT)

## ▽ : GROUND POINTS

CODE	SEE PAGE	GROUND POINTS LOCATION
BL	40	UNDER THE FRONT SEAT RH
BM	40	LUGGAGE ROOM LEFT

## ○ : SPLICE POINTS

CODE	SEE PAGE	WIRE HARNESS WITH SPLICE POINTS	CODE	SEE PAGE	WIRE HARNESS WITH SPLICE POINTS
I18	38	COWL WIRE	I41	38	COWL WIRE

B 6, B 7

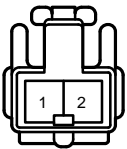

J12

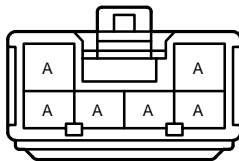

T17, T18

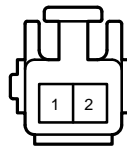

(HINT : SEE PAGE 7)



\*1 : FULLY-CONCEALED/SEMI-CONCEALED CHENGEOVER SW  
 \*2 : CANADA  
 \*3 : USA

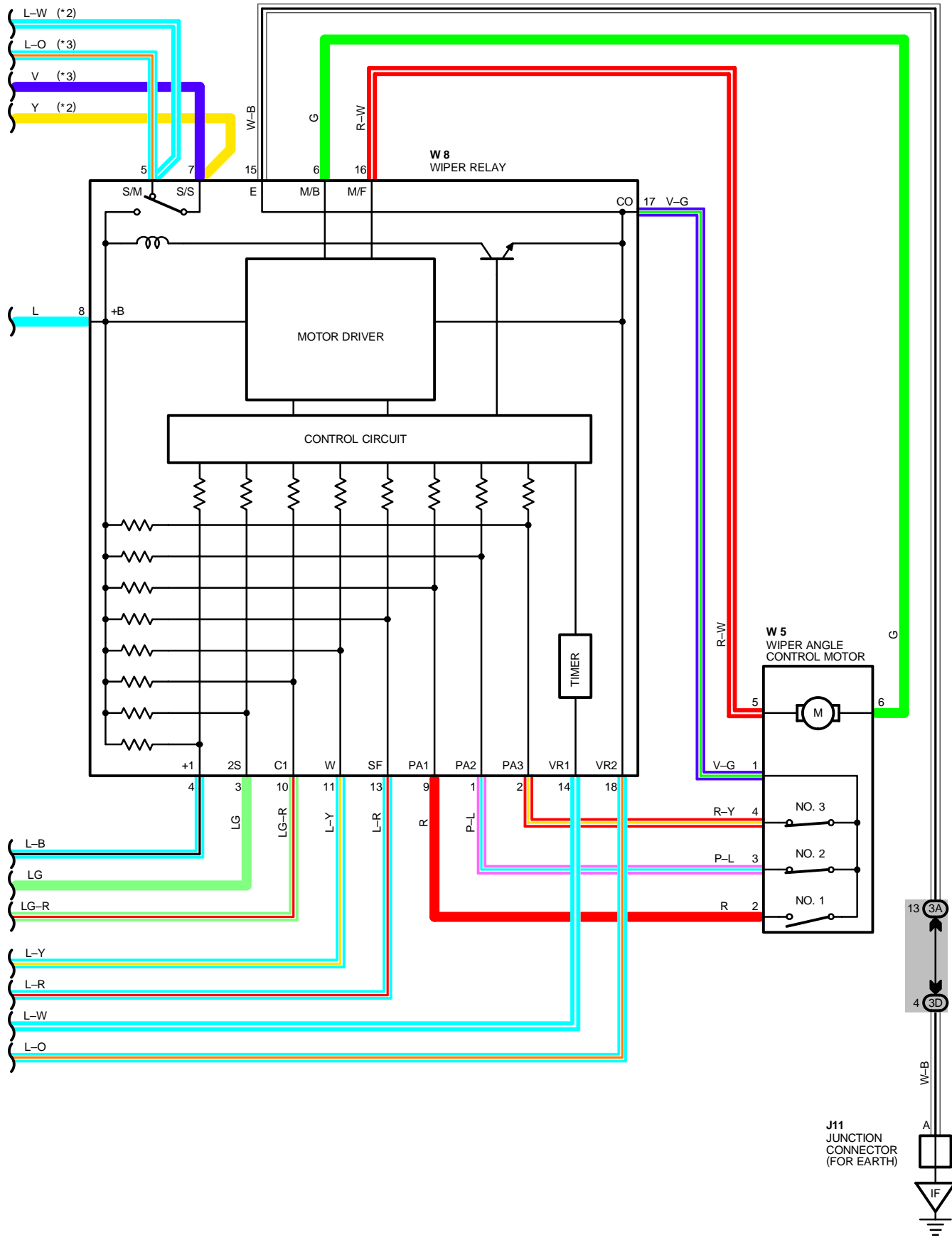

# WIPER AND WASHER

## SYSTEM OUTLINE

### 1. LOW SPEED POSITION

WIPER SW AT LOW OR INT POSITION

WHEN THE WIPER AND WASHER SW ARE AT LOW POSITION, A SIGNAL IS OUTPUT FROM **TERMINAL (A)11** OF THE WIPER SW TO **TERMINAL 13** OF THE WIPER RELAY. THIS SIGNAL ACTIVATES THE WIPER RELAY SO THAT CURRENT FLOWS FROM THE **WIPER FUSE** TO **TERMINAL 8** OF WIPER RELAY → **TERMINAL 16** → **TERMINAL 5** OF WIPER ANGLE CONTROL MOTOR → **TERMINAL 6** → **TERMINAL 6** OF WIPER RELAY → **TERMINAL 15** → **GROUND**, ACTIVATING THE WIPER ANGLE CONTROL MOTOR SO THAT THE WIPERS OPERATE AT LOW SPEED WITH THE WIPER ARMS AT THE RAISED POSITION.

WIPER SW AT HIGH POSITION

WHEN THE WIPER AND WASHER SW ARE AT HIGH POSITION, A SIGNAL IS OUTPUT FROM **TERMINAL (A)11, (A)12** OF THE WIPER SW TO **TERMINAL 13, 3** OF THE WIPER RELAY. THIS SIGNAL ACTIVATES THE WIPER RELAY SO THAT CURRENT FLOWS THE SAME AS WHEN THE WIPER SW IS AT LOW OR INT POSITION, THUS ACTIVATING THE WIPER ANGLE CONTROL MOTOR. AS A RESULT, THE WIPERS OPERATE AT HIGH SPEED WITH THE WIPER ARMS AT THE RAISED POSITION. THE RETURN POSITION OF THE WIPER BLADES IS ALSO AUTOMATICALLY ADJUSTED TO A DIFFERENT POSITION TO LOW SPEED OR INT OPERATION TO PREVENT OVERRUN.

### 2. LOW SPEED OPERATION

WHEN THE WIPER SW IS AT LOW POSITION, THE WIPER ANGLE CONTROL MOTOR SETS THE WIPER ARMS AT THE RAISED POSITION. AT THE SAME TIME, CURRENT FROM THE **WIPER FUSE** FLOWS TO **TERMINAL (A)14** OF WIPER AND WASHER SW → **TERMINAL (B)1** → **TERMINAL 3** OF WIPER MOTOR → **TERMINAL 1** → **GROUND**, OPERATING THE WIPER MOTOR AT LOW SPEED.

### 3. INT POSITION

WHEN THE WIPER SW IS AT HIGH POSITION, CURRENT FROM THE **WIPER FUSE** FLOWS TO **TERMINAL (A)14** OF WIPER AND WASHER SW → **TERMINAL (A)7** → **TERMINAL 2** OF WIPER MOTOR → **TERMINAL 1** → **GROUND**, OPERATING THE WIPER MOTOR AT HIGH SPEED. AT THE SAME TIME, THE WIPER ANGLE CONTROL MOTOR SETS THE WIPER ARMS TO RAISE POSITION AND AUTOMATICALLY CHANGES THE RETURN POSITION OF THE WIPER BLADES TO PREVENT OVERRUN.

### 4. MIST POSITION

WHEN THE WIPER SW IS AT INT POSITION. THE WIPER ANGLE CONTROL MOTOR SETS THE WIPER ARM TO RAISED POSITION. AT THE SAME TIME. A SIGNAL IS OUTPUT FROM **TERMINAL (A)5** OF THE WIPER AND WASHER SW TO **TERMINAL 10** OF THE WIPER RELAY. THIS SIGNAL ACTIVATES THE WIPER RELAY, AND FOR **0.6** TO **1.0** SECOND. CURRENT FROM THE **WIPER FUSE** FLOWS TO **TERMINAL 8** OF THE WIPER RELAY → **TERMINAL 4** → **TERMINAL 3** OF WIPER MOTOR → **TERMINAL 1** TO **GROUND**, ACTIVATING THE WIPER MOTOR. THEN APPROX **2** SECONDS TO **10** SECONDS AFTER WIPER OPERATION STOPS, CURRENT AGAIN FLOWS FROM **TERMINAL 8** OF THE WIPER RELAY TO **TERMINAL 4**. ACTIVATING THE WIPER MOTOR. THIS OPERATION REPEATS WHILE THE WIPER SW IS AT INT POSITION. THE TIME INTERVAL BETWEEN WIPER OPERATION CAN BE ADJUSTED USING THE INT TIME CONTROL SW.

### 5. FULLY-CONCEALED/SEMICONCEALED CHANGEROVER OPERATION

WHEN THE FULLY-CONCEALED/SEMI-CONCEALED CHANGEROVER OPERATION SWITCH IS CHANGED FROM FULL TO SEMI, A SIGNAL IS OUTPUT FROM **TERMINAL (A)11** OF THE WIPER AND WASHER SW TO **TERMINAL 13** OF THE WIPER RELAY. THIS SIGNAL ACTIVATES THE WIPER RELAY SO THAT CURRENT FLOWS THE SAME ROUTE AS WHEN THE WIPER SW IS AT LOW OR INT POSITION. AS A RESULT, THE WIPER ANGLE CONTROL MOTOR OPERATES AND MOVES THE WIPER ARMS TO THE RAISED POSITION.

WHEN THE CHANGEROVER SW IS SWITCHED FROM SEMI TO FULL, A SIGNAL IS OUTPUT FROM **TERMINAL (A)11** OF THE WIPER AND WASHER SW TO **TERMINAL 13** OF THE WIPER RELAY. THIS SIGNAL ACTIVATES THE WIPER RELAY SO THAT CURRENT FLOWS FROM THE **WIPER FUSE** TO **TERMINAL 8** OF THE WIPER RELAY → **TERMINAL 6** → **TERMINAL 6** OF WIPER ANGLE CONTROL MOTOR → **TERMINAL 5** → **TERMINAL 16** OF WIPER RELAY → **GROUND**. THIS ACTIVATES THE WIPER ANGLE CONTROL MOTOR SO THAT THE WIPER ARM MOVES FROM THE RAISED POSITION TO THE STORED POSITION.

### 6. WASHER CONTINUOUS OPERATION

WHEN THE WASHER SW IS ON, CURRENT FROM THE **WIPER FUSE** FLOWS TO **TERMINAL 2** OF THE WASHER MOTOR → **TERMINAL 1** → **GROUND**, ACTIVATING THE WASHER MOTOR TO SPRAY WASHER FLUID ON THE WINDSHIELD. AT THE SAME TIME. A SIGNAL IS INPUT TO **TERMINAL 11** OF THE WIPER RELAY, ACTIVATING THE WIPER RELAY AND RAISING THE WIPER ARM. CURRENT FLOWS FROM THE **WIPER FUSE** TO **TERMINAL 8** → **TERMINAL 4** → **TERMINAL 3** OF WIPER MOTOR → **GROUND**.



## SERVICE HINTS

### C12(A), C13(B) WIPER AND WASHER SW [COMB. SW]

(A) 6-GROUND : ALWAYS CONTINUITY

(A) 14-GROUND : APPROX. 12 VOLTS WITH IGNITION SW AT **ON** POSITION

(B) 1-GROUND : APPROX. 12 VOLTS WITH WIPER AND WASHER SW AT **LOW** POSITION

APPROX. 12 VOLTS 2 TO 10 SECONDS INTERMITTENTLY WITH WIPER SW AT **INT** POSITION

(B) 10-GROUND : APPROX. 12 VOLTS WITH IGNITION SW ON UNLESS WIPER MOTOR AT **STOP** POSITION

(A) 7-GROUND : APPROX. 12 VOLTS WITH WIPER AND WASHER SW AT **HIGH** POSITION

### W 6 WIPER MOTOR

4-5 : CLOSED UNLESS WIPER MOTOR AT **STOP** POSITION

### ○ : PARTS LOCATION

CODE	SEE PAGE	CODE	SEE PAGE	CODE	SEE PAGE	
C12	A	28	J 7	29	W 6	27
C13	B	28	J11	29	W 8	29
J 2	29	W 2	27			
J 5	29	W 5	27			

### ○ : JUNCTION BLOCK AND WIRE HARNESS CONNECTOR

CODE	SEE PAGE	JUNCTION BLOCK AND WIRE HARNESS (CONNECTOR LOCATION)
1A	20	COWL WIRE AND J/B NO. 1 (LEFT KICK PANEL)
1D		
1H		
3A	22	COWL WIRE AND J/B NO. 3 (BEHIND THE INSTRUMENT PANEL CENTER)
3D		

### ▽ : GROUND POINTS

CODE	SEE PAGE	GROUND POINTS LOCATION
IE	36	LEFT KICK PANEL
IF	36	BEHIND COMBINATION METER

### ○ : SPLICE POINTS

CODE	SEE PAGE	WIRE HARNESS WITH SPLICE POINTS	CODE	SEE PAGE	WIRE HARNESS WITH SPLICE POINTS
I17	38	COWL WIRE	I40	38	COWL WIRE

C12 (A) BLACK

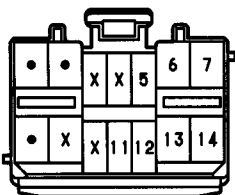

C13 (B)

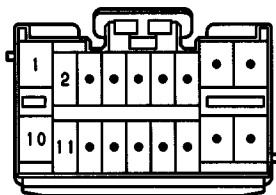

J 2



J 5 BLACK



J 7 GRAY



J11



W 2 BLACK

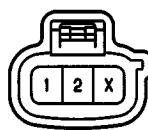

W 5 DARK GRAY



W 6 GRAY



W 8

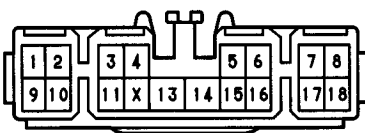

# REAR WINDOW DEFOGGER AND MIRROR HEATER

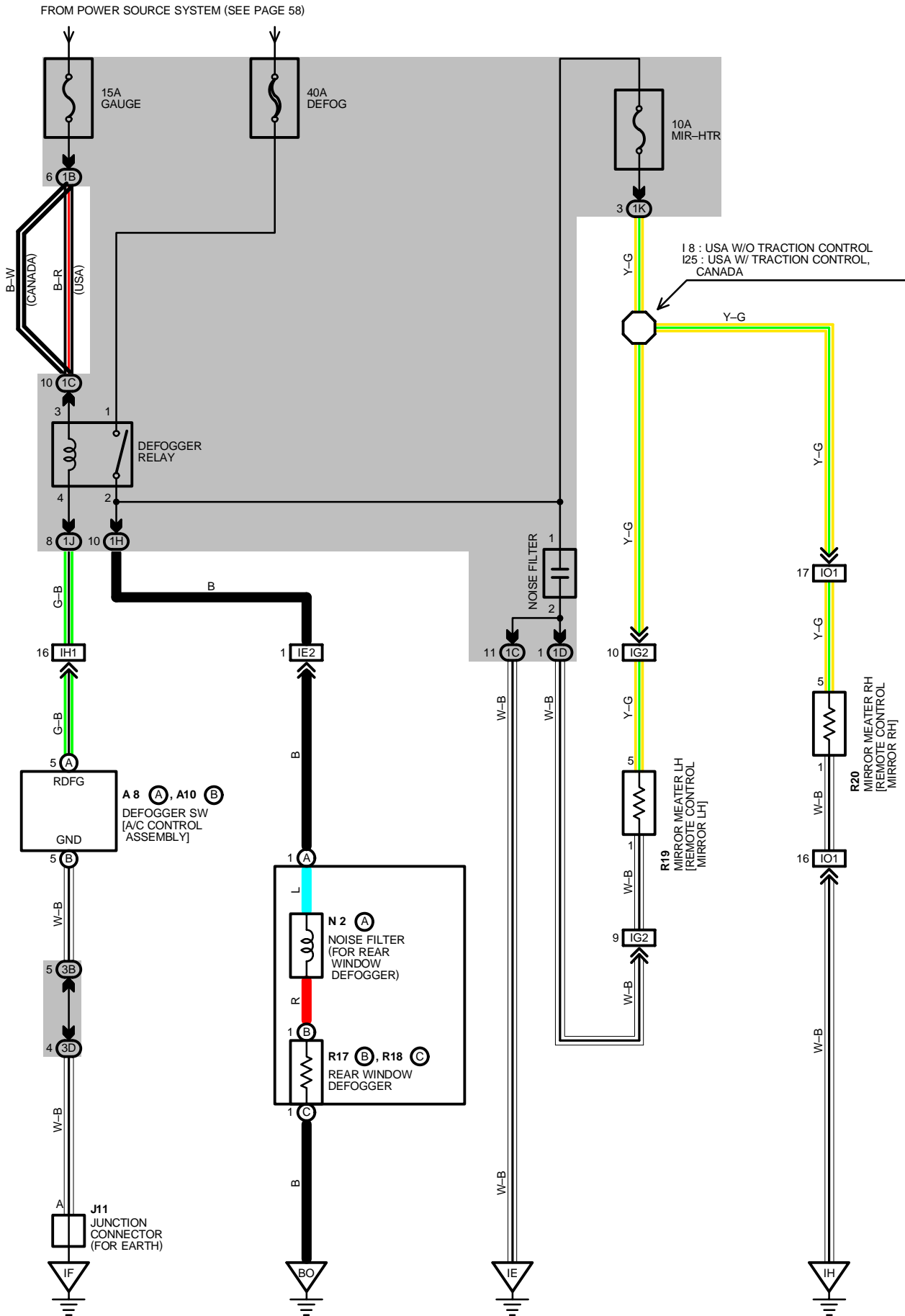

## SERVICE HINTS

### DEFOGGER RELAY

1-2 : CLOSED WITH IGNITION SW AT **ON** POSITION AND DEFOGGER SW [A/C CONTROL ASSEMBLY] **ON** POSITION

### ○ : PARTS LOCATION

CODE	SEE PAGE	CODE	SEE PAGE	CODE	SEE PAGE
A 8	A 28	N 2	A 31	R19	31
A10	B 28	R17	B 31	R20	31
J11	29	R18	C 31		

### ○ : JUNCTION BLOCK AND WIRE HARNESS CONNECTOR

CODE	SEE PAGE	JUNCTION BLOCK AND WIRE HARNESS (CONNECTOR LOCATION)
1B	20	COWL WIRE AND J/B NO. 1 (LEFT KICK PANEL)
1C		
1D		
1H		
1J		
1K		
3B	22	INSTRUMENT PANEL WIRE AND J/B NO. 3 (BEHIND THE INSTRUMENT PANEL CENTER)
3D	22	COWL WIRE AND J/B NO. 3 (BEHIND THE INSTRUMENT PANEL CENTER)

### □ : CONNECTOR JOINING WIRE HARNESS AND WIRE HARNESS

CODE	SEE PAGE	JOINING WIRE HARNESS AND WIRE HARNESS (CONNECTOR LOCATION)
IE2	36	COWL WIRE AND FLOOR NO. 2 WIRE (LEFT KICK PANEL)
IG2	36	FRONT DOOR LH WIRE AND COWL WIRE (LEFT KICK PANEL)
IH1	36	COWL WIRE AND INSTRUMENT PANEL WIRE (BEHIND GLOVE BOX)
IO1	38	FRONT DOOR RH WIRE AND COWL WIRE (RIGHT KICK PANEL)

### ▽ : GROUND POINTS

CODE	SEE PAGE	GROUND POINTS LOCATION
IE	36	LEFT KICK PANEL
IF	36	BEHIND COMBINATION METER
IH	36	RIGHT KICK PANEL
BO	40	LEFT SIDE OF REAR PILLAR

### ○ : SPLICE POINTS

CODE	SEE PAGE	WIRE HARNESS WITH SPLICE POINTS	CODE	SEE PAGE	WIRE HARNESS WITH SPLICE POINTS
I 8	38	COWL WIRE	I25	38	COWL WIRE

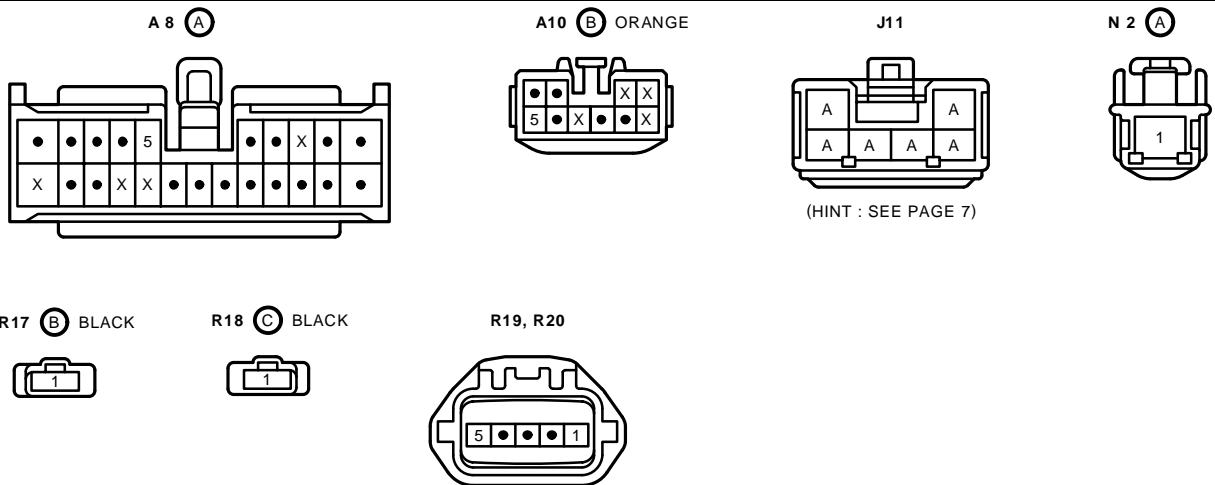



## SERVICE HINTS

### A31 AUTO ANTENNA MOTOR AND RELAY

- 3-GROUND : ALWAYS APPROX. 12 VOLTS
- 6-GROUND : APPROX. 12 VOLTS WITH IGNITION SW AT **ON** POSITION
- 8-GROUND : APPROX. 12 VOLTS WITH IGNITION SW AT **ACC OR ON** POSITION
- 7-GROUND : ALWAYS CONTINUITY

### R 3 RADIO AND PLAYER

- 5-GROUND : APPROX. 12 VOLTS WITH IGNITION SW AT **ACC OR ON** POSITION

### ○ : PARTS LOCATION

CODE	SEE PAGE	CODE	SEE PAGE	CODE	SEE PAGE
A31	30	J12	30	R 3	29

### ○ : RELAY BLOCKS

CODE	SEE PAGE	RELAY BLOCKS (RELAY BLOCK LOCATION)
2	19	R/B NO. 2 (ENGINE COMPARTMENT LEFT)

### ○ : JUNCTION BLOCK AND WIRE HARNESS CONNECTOR

CODE	SEE PAGE	JUNCTION BLOCK AND WIRE HARNESS (CONNECTOR LOCATION)
1A	20	COWL WIRE AND J/B NO. 1 (LEFT KICK PANEL)
1C		
1J		
1L		
3B	22	INSTRUMENT PANEL WIRE AND J/B NO. 3 (BEHIND THE INSTRUMENT PANEL CENTER)
3D	22	COWL WIRE AND J/B NO. 3 (BEHIND THE INSTRUMENT PANEL CENTER)

### □ : CONNECTOR JOINING WIRE HARNESS AND WIRE HARNESS

CODE	SEE PAGE	JOINING WIRE HARNESS AND WIRE HARNESS (CONNECTOR LOCATION)
EB1	34	COWL WIRE AND R/B NO. 2 WIRE (INSIDE OF R/B NO. 2)
IE1	36	COWL WIRE AND FLOOR NO. 2 WIRE (LEFT KICK PANEL)
IJ2	36	INSTRUMENT PANEL WIRE AND FLOOR NO. 1 WIRE (UNDER THE INSTRUMENT PANEL BRACE LH)
IM1	38	COWL WIRE AND FLOOR NO. 1 WIRE (RIGHT KICK PANEL)
BS1	40	FLOOR NO. 1 WIRE AND FLOOR NO. 2 WIRE (UNDER THE LEFT SIDE OF REAR SEAT CUSHION)

### ▽ : GROUND POINTS

CODE	SEE PAGE	GROUND POINTS LOCATION
BM	40	LUGGAGE ROOM LEFT

A31

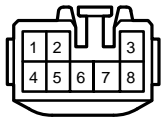

J12

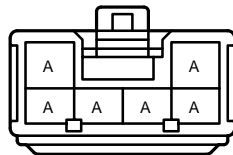

(HINT : SEE PAGE 7)

R 3 BLUE

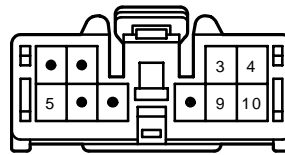

# RADIO AND PLAYER

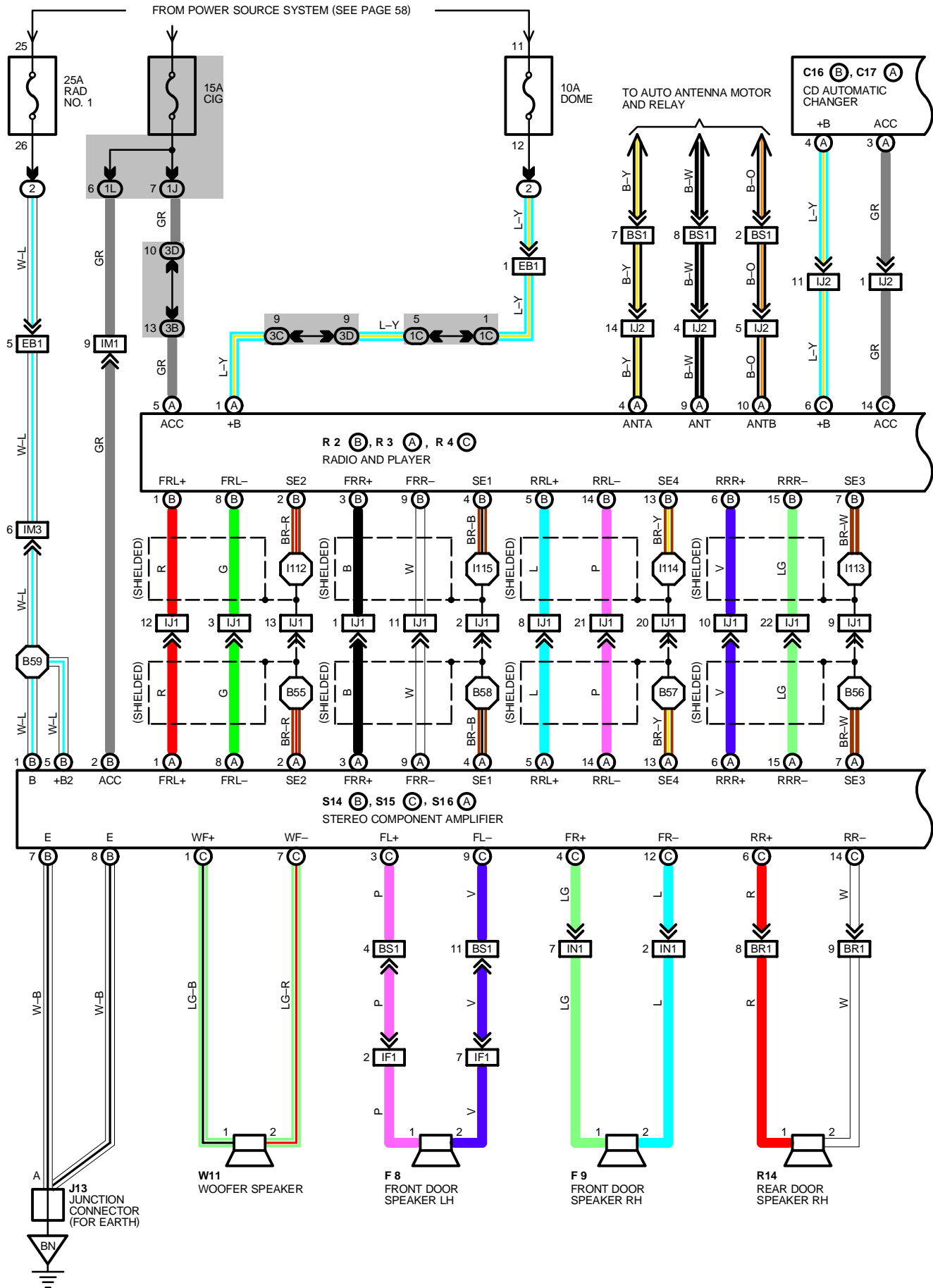



# RADIO AND PLAYER

## SERVICE HINTS

### R 3(A) RADIO AND PLAYER

- (A) 1-GROUND : ALWAYS APPROX. 12 VOLTS
- (A) 5-GROUND : APPROX. 12 VOLTS WITH IGNITION SW AT **ON** OR **ACC** POSITION
- (A) 7-GROUND : ALWAYS CONTINUITY

### C17(A) CD AUTOMATIC CHANGER

- (A) 4-GROUND : ALWAYS APPROX. 12 VOLTS
- (A) 3-GROUND : APPROX. 12 VOLTS WITH IGNITION SW AT **ON** OR **ACC** POSITION
- (A) 9-GROUND : ALWAYS CONTINUITY

### S14(B) STEREO COMPONENT AMPLIFIER

- (B)1, (B)5-GROUND : ALWAYS APPROX. 12 VOLTS
- (B) 2-GROUND : APPROX. 12 VOLTS WITH IGNITION SW AT **ON** OR **ACC** POSITION
- (B)7, (B)8-GROUND : ALWAYS CONTINUITY

## ○ : PARTS LOCATION

CODE		SEE PAGE	CODE		SEE PAGE	CODE		SEE PAGE
C16	B	30	L 8		30	S14	B	31
C17	A	30	R 2	B	29	S15	C	31
F 8		30	R 3	A	29	S16	A	31
F 9		30	R 4	C	29	T15	B	31
J 6		29	R 8		29	T16	A	31
J 7		29	R13		31	W11		31
J13		30	R14		31			

## ○ : RELAY BLOCKS

CODE	SEE PAGE	RELAY BLOCKS (RELAY BLOCK LOCATION)
2	19	R/B NO. 2 (ENGINE COMPARTMENT LEFT)

## ○ : JUNCTION BLOCK AND WIRE HARNESS CONNECTOR

CODE	SEE PAGE	JUNCTION BLOCK AND WIRE HARNESS (CONNECTOR LOCATION)
1C	20	COWL WIRE AND J/B NO. 1 (LEFT KICK PANEL)
1H		
1J		
1L		
3B	22	INSTRUMENT PANEL WIRE AND J/B NO. 3 (BEHIND THE INSTRUMENT PANEL CENTER)
3C		
3D	22	COWL WIRE AND J/B NO. 3 (BEHIND THE INSTRUMENT PANEL CENTER)
3E		

## □ : CONNECTOR JOINING WIRE HARNESS AND WIRE HARNESS

CODE	SEE PAGE	JOINING WIRE HARNESS AND WIRE HARNESS (CONNECTOR LOCATION)
EB1	34	COWL WIRE AND R/B NO. 2 WIRE (INSIDE OF R/B NO. 2)
IF1	36	FRONT DOOR LH WIRE AND FLOOR NO. 2 WIRE (LEFT KICK PANEL)
IH2	36	COWL WIRE AND INSTRUMENT PANEL WIRE (BEHIND GLOVE BOX)
IJ1	36	INSTRUMENT PANEL WIRE AND FLOOR NO. 1 WIRE (UNDER THE INSTRUMENT PANEL BRACE LH)
IJ2		
IM1	38	COWL WIRE AND FLOOR NO. 1 WIRE (RIGHT KICK PANEL)
IM3		
IN1	38	FRONT DOOR RH WIRE AND FLOOR NO. 1 WIRE (RIGHT KICK PANEL)
BQ1	40	REAR DOOR LH WIRE AND FLOOR NO. 2 WIRE (LEFT CENTER PILLAR)
BR1	40	REAR DOOR RH WIRE AND FLOOR NO. 1 WIRE (RIGHT CENTER PILLAR)
BS1	40	FLOOR NO.1 WIRE AND FLOOR NO. 2 WIRE (UNDER THE LEFT SIDE OF REAR SEAT CUSHION)
BS3		

## ▽ : GROUND POINTS

CODE	SEE PAGE	GROUND POINTS LOCATION
IG	36	BEHIND GLOVE BOX
II	36	INSTRUMENT PANEL BRACE LH
BN	40	LUGGAGE ROOM RIGHT





**: SPLICE POINTS**

CODE	SEE PAGE	WIRE HARNESS WITH SPLICE POINTS	CODE	SEE PAGE	WIRE HARNESS WITH SPLICE POINTS
I112	38	INSTRUMENT PANEL WIRE	B44	40	FLOOR NO. 1 WIRE
I113			B55		
I114			B56		
I115			B57		
I116			B58		
B22	40	FLOOR NO. 1 WIRE	B59		
B24					

**C16 (B) GRAY**

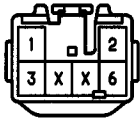

**C17 (A) GRAY**

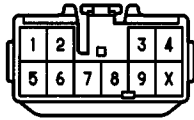

**F 8, F 9 BLUE**



**J 6 GRAY**

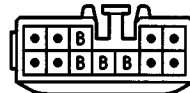

(HINT:SEE PAGE 7)

**J 7 GRAY**

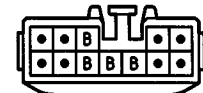

(HINT:SEE PAGE 7)

**J13**

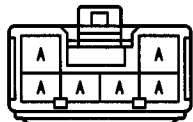

(HINT:SEE PAGE 7)

**L 8 GRAY**



**R 2 (B)**

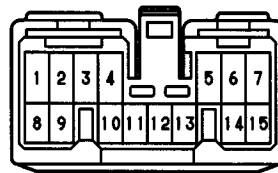

**R 3 (A) BLUE**



**R 4 (C) GRAY**

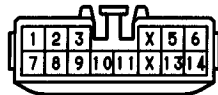

**R 8**



**R13, R14 BLUE**



**S14 (B) BLUE**

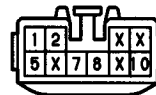

**S15 (C) ORANGE**

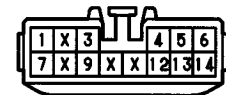

**S16 (A)**

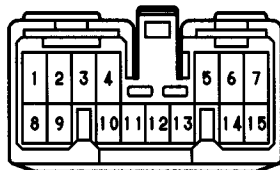

**T15 (B)**

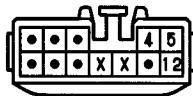

**T16 (A)**

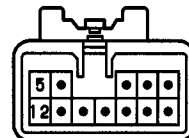

**W11 BLUE**



# COMBINATION METER

FROM POWER SOURCE SYSTEM (SEE PAGE 58)

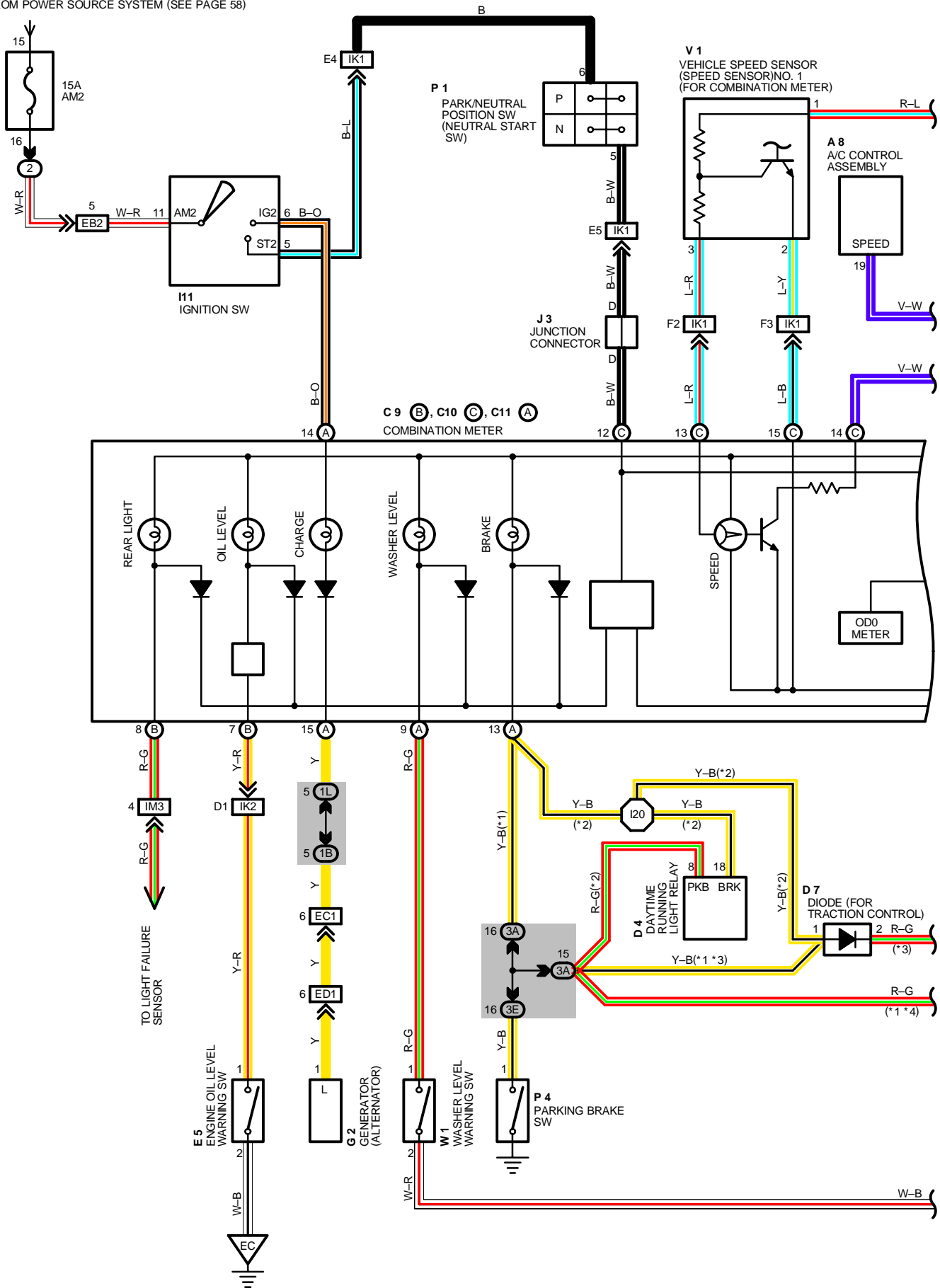

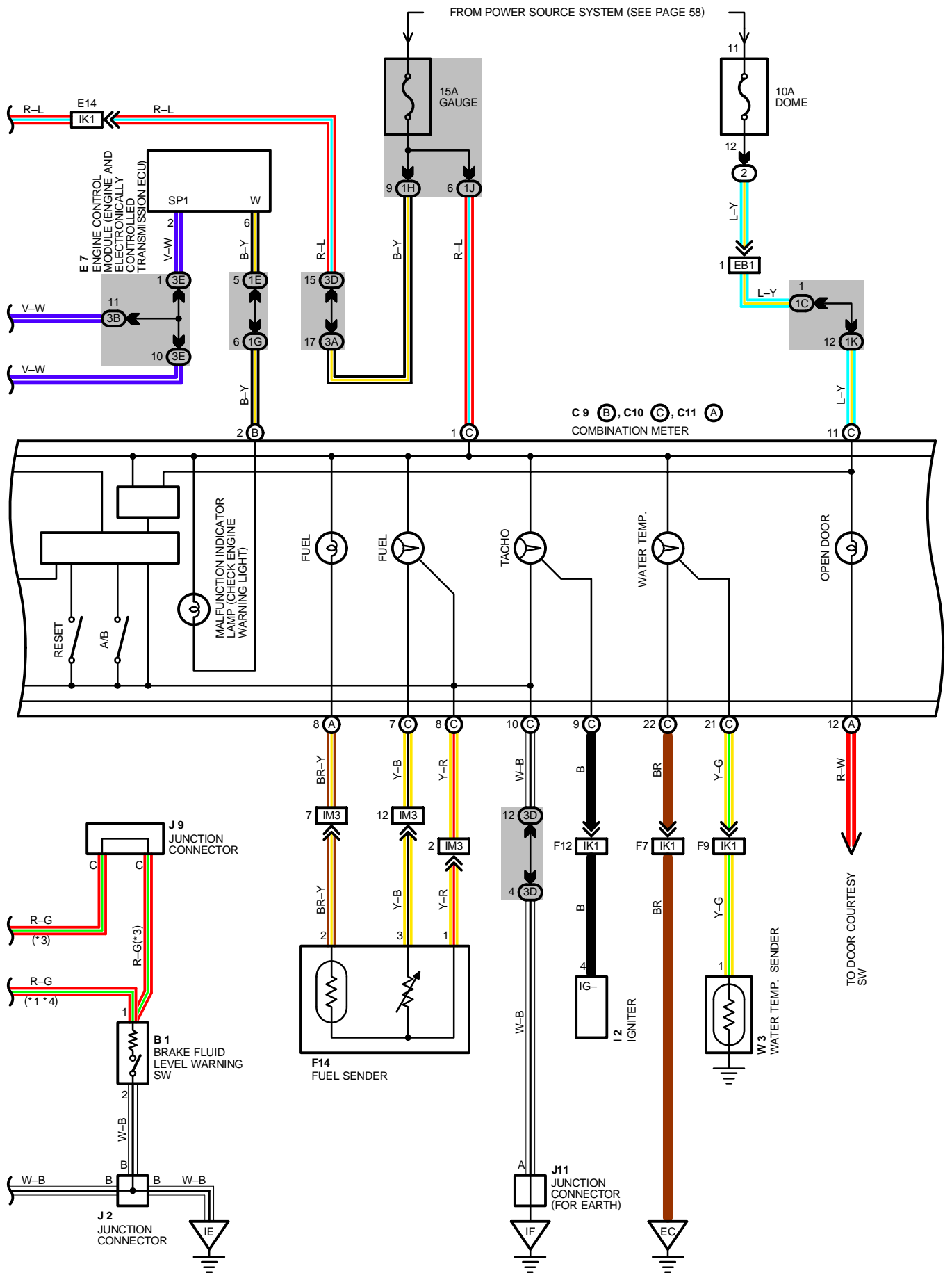

# COMBINATION METER

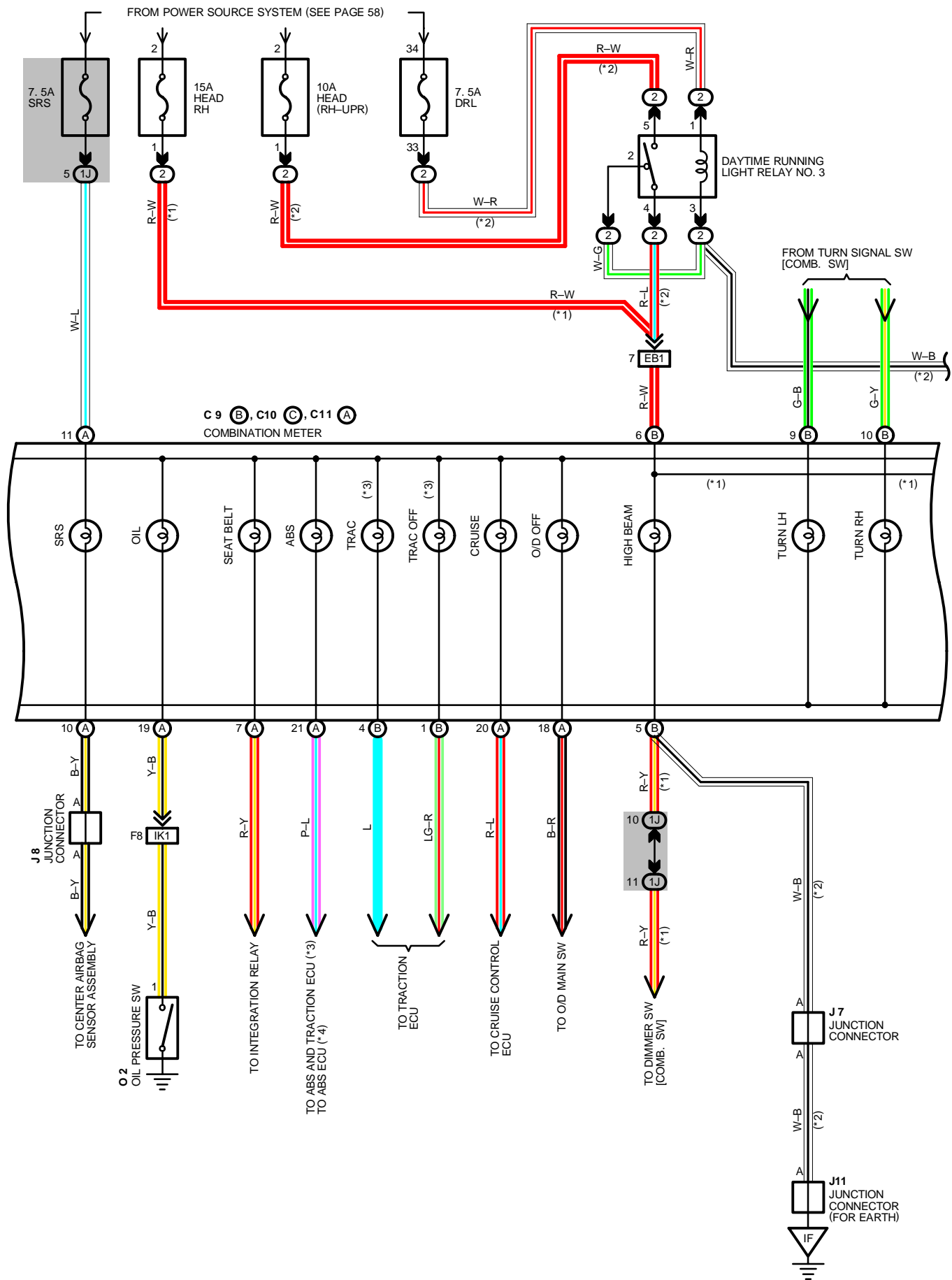

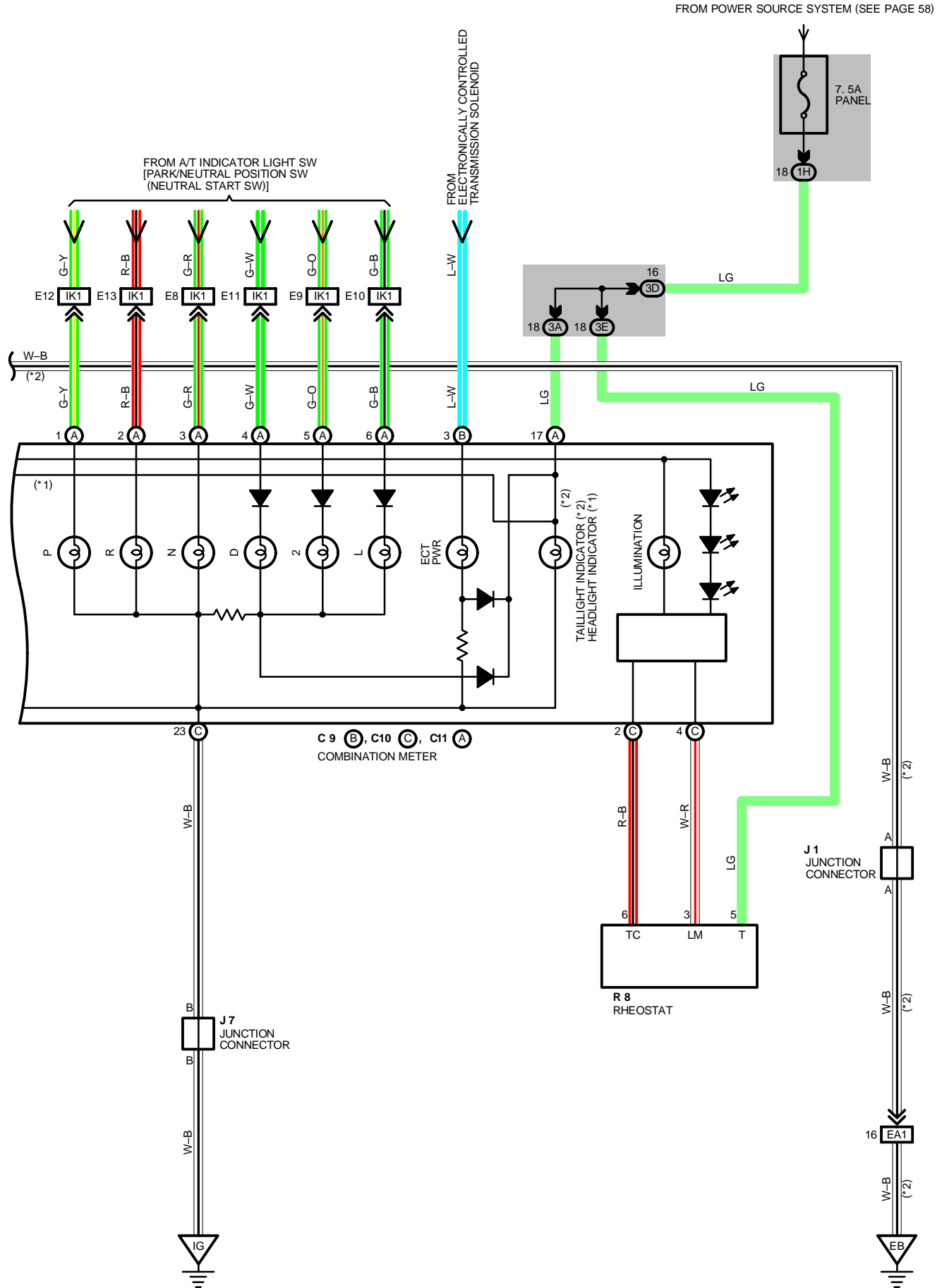

# COMBINATION METER

## SERVICE HINTS

### B 1 BRAKE FLUID LEVEL WARNING SW

1-2 : CLOSED WITH FLOAT DOWN

### P 4 PARKING BRAKE SW

1-GROUND : CLOSED WITH PARKING BRAKE PEDAL DEPRESSED

### O 2 OIL PRESSURE SW

1-GROUND : CLOSED WITH OIL PRESSURE BELOW APPROX. 20 KPA (2.8 PSI, 0.2 KG/CM<sup>2</sup>)

### W 3 WATER TEMP. SENDER

1-GROUND : APPROX. 226 (50°C, 122°F)

APPROX. 25 (115°C, 239°F)

### E 5 ENGINE OIL LEVEL WARNING SW

1-2 : CLOSED WITH FLOAT UP AND ENGINE OIL TEMP. AT BELOW APPROX. 55°C (131°F)

OPEN WITH FLOAT DOWN AND ENGINE OIL TEMP. AT BELOW APPROX. 60°C (140°F)

### F14 FUEL SENDER

2-3 : APPROX. 3 AT FUEL FULL

APPROX. 110 AT FUEL EMPTY

### C10(C) COMBINATION METER

1-GROUND : APPROX. 12 VOLTS WITH IGNITION SW AT ON POSITION

12-GROUND : APPROX. 12 VOLTS WITH IGNITION SW AT ST POSITION AND SHIFT LEVER AT P OR N POSITION

10-GROUND : ALWAYS CONTINUITY

22-GROUND : ALWAYS CONTINUITY

11-GROUND : ALWAYS APPROX. 12 VOLTS

## ○ : PARTS LOCATION

CODE	SEE PAGE	CODE	SEE PAGE	CODE	SEE PAGE
A 8	28	F14	30	J 9	29
B 1	26	G 2	26	J11	29
C 9	B 28	I 2	26	O 2	27
C10	C 28	I11	29	P 1	27
C11	A 28	J 1	27	P 4	29
D 4	28	J 2	29	R 8	29
D 7	28	J 3	29	V 1	27
E 5	26	J 7	29	W 1	27
E 7	28	J 8	29	W 3	27

## ○ : RELAY BLOCKS

CODE	SEE PAGE	RELAY BLOCKS (RELAY BLOCK LOCATION)
2	19	R/B NO. 2 (ENGINE COMPARTMENT LEFT)

## ○ : JUNCTION BLOCK AND WIRE HARNESS CONNECTOR

CODE	SEE PAGE	JUNCTION BLOCK AND WIRE HARNESS (CONNECTOR LOCATION)
1B	20	COWL WIRE AND J/B NO. 1 (LEFT KICK PANEL)
1C		
1E		
1G		
1H		
1J		
1K		
1L		
3A	22	COWL WIRE AND J/B NO. 3 (BEHIND THE INSTRUMENT PANEL CENTER)
3B	22	INSTRUMENT PANEL WIRE AND J/B NO. 3 (BEHIND THE INSTRUMENT PANEL CENTER)
3D	22	COWL WIRE AND J/B NO. 3 (BEHIND THE INSTRUMENT PANEL CENTER)
3E		

## □ : CONNECTOR JOINING WIRE HARNESS AND WIRE HARNESS

CODE	SEE PAGE	JOINING WIRE HARNESS AND WIRE HARNESS (CONNECTOR LOCATION)
EA1	34	ENGINE ROOM MAIN WIRE AND R/B NO. 2 WIRE (INSIDE OF R/B NO. 2)
EB1	34	COWL WIRE AND R/B NO. 2 WIRE (INSIDE OF R/B NO. 2)
EB2		
EC1	34	COWL WIRE AND ENGINE ROOM MAIN WIRE (INSIDE OF R/B NO. 2)
ED1	34	ENGINE ROOM MAIN WIRE AND ENGINE NO. 4 WIRE (NEAR THE R/B NO. 2)
IK1	38	ENGINE WIRE AND COWL WIRE (UNDER THE GLOVE BOX)
IK2		
IM3	38	COWL WIRE AND FLOOR NO. 1 WIRE (RIGHT KICK PANEL)

**▽ : GROUND POINTS**

CODE	SEE PAGE	GROUND POINTS LOCATION
EB	34	FRONT SIDE OF LEFT FENDER
EC	34	FRONT SIDE OF INTAKE MANIFOLD
IE	36	LEFT KICK PANEL
IF	36	BEHIND COMBINATION METER
IG	36	BEHIND GLOVE BOX

**○ : SPLICE POINTS**

CODE	SEE PAGE	WIRE HARNESS WITH SPLICE POINTS	CODE	SEE PAGE	WIRE HARNESS WITH SPLICE POINTS
I20	38	COWL WIRE			

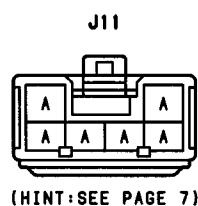
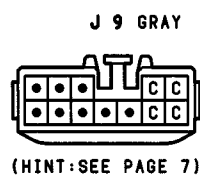
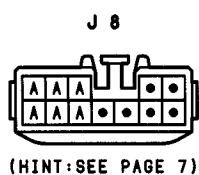
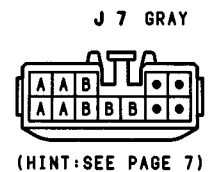
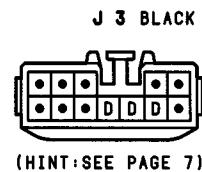
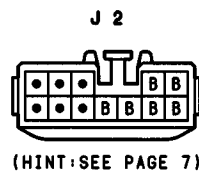
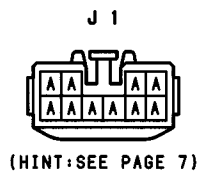
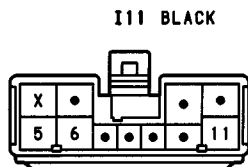
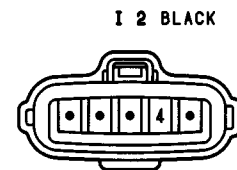
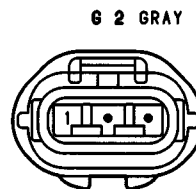
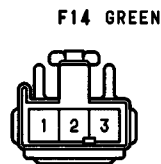
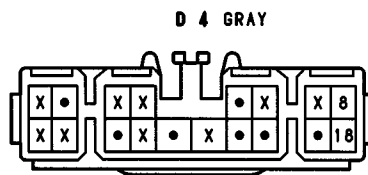
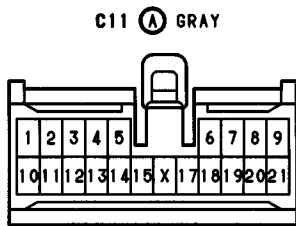
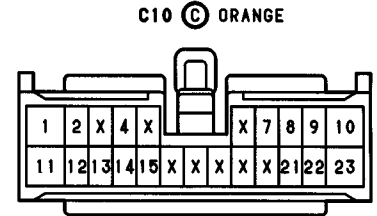
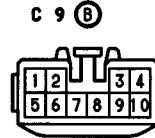
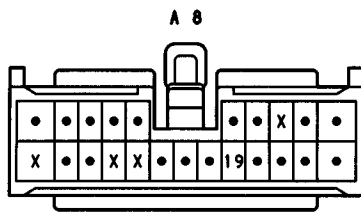

# COMBINATION METER

---

O 2 GRAY



P 1 GRAY

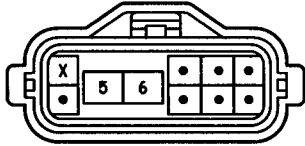

P 4 GRAY



R 6



V 1 BLACK



W 1 GRAY



W 3 GRAY





---

# RADIATOR FAN AND AUTOMATIC AIR CONDITIONING

## SYSTEM OUTLINE

### 1. HEATER BLOWER OPERATION

#### MANUAL BLOWER OPERATION

WHEN THE BLOWER CONTROL SW IS SET TO ANY BLOWER SPEED, THE A/C CONTROL ASSEMBLY OPERATES AND THE CURRENT TO DRIVE THE BLOWER MOTOR FLOWS FROM **TERMINAL BLW** OF THE A/C CONTROL ASSEMBLY TO **TERMINAL SI** OF THE BLOWER MOTOR CONTROL RELAY. THE CURRENT ACTIVATES THE RELAY AND THE VOLTAGE APPLIED TO **TERMINAL +B** OF THE BLOWER MOTOR CONTROL RELAY IS OUTPUT AT **TERMINAL M+** AS THE VOLTAGE FOR THE SELECTED BLOWER SPEED. THE CURRENT THEN FLOWS FROM **TERMINAL M+** OF THE BLOWER MOTOR CONTROL RELAY TO **TERMINAL 2** → **TERMINAL 1** → **TERMINAL M-** OF BLOWER MOTOR CONTROL RELAY → **TERMINAL GND** → **GROUND**, AND THE BLOWER MOTOR OPERATES AT THE BLOWER SPEED SELECTED.

#### AUTO FUNCTION

WHEN THE AUTO SW IS TURNED ON, THE A/C CONTROL ASSEMBLY CALCULATES THE REQUIRED VENT TEMPERATURE BASED ON THE SET TEMPERATURE AND INPUT FROM EACH SENSOR. THEN **TERMINAL BLW** OF THE A/C CONTROL ASSEMBLY INPUTS CURRENT TO **TERMINAL SI** OF THE BLOWER MOTOR CONTROL RELAY IN CONFORMITY WITH THE REQUIRED VENT OUTPUT. THIS CURRENT ACTIVATES THE BLOWER MOTOR CONTROL RELAY SO THAT CURRENT FLOWS FROM **TERMINAL M+** OF THE BLOWER MOTOR CONTROL RELAY → **TERMINAL 2** OF BLOWER MOTOR → **TERMINAL 1** → **TERMINAL M-** OF BLOWER MOTOR CONTROL RELAY → **TERMINAL GND** → **GROUND**, ACTIVATING THE BLOWER MOTOR. THE BLOWER MOTOR THEN OPERATES AT DIFFERENT STEPS IN CONFORMITY WITH VARIABLE CURRENT FLOW OUTPUT FROM **TERMINAL BLW** OF THE A/C CONTROL ASSEMBLY TO **TERMINAL SI** OF THE BLOWER MOTOR CONTROL RELAY.

### 2. OPERATION OF AIR INLET CONTROL SERVO MOTOR

(SWITCHING FROM FRESH TO RECIRC)

WITH IGNITION SW TURNED ON, THE CURRENT FLOWS FROM GAUGE FUSE TO **TERMINAL IG** OF A/C CONTROL ASSEMBLY → **TERMINAL AIR** → **TERMINAL 2** (F AIR INLET CONTROL SERVO MOTOR → **TERMINAL 1** → **TERMINAL AIF** OF A/C CONTROL ASSEMBLY → **TERMINAL GND** → **GROUND**, THE MOTOR ROTATES AND THE DAMPER MOVES TO THE RECIRC SIDE. WHILE THE DAMPER OPERATES, THE DAMPER POSITION CONTROL SIGNAL IS INPUT FROM **TERMINAL 5** OF THE SERVO MOTOR TO **TERMINAL TPI** OF THE ECU (BUILT INTO THE A/C CONTROL ASSEMBLY). AS A RESULT, CURRENT TO THE SERVO MOTOR CIRCUIT IS CUT OFF BY THE ECU, SO THE DAMPER STOPS AT THAT POSITION.

(SWITCHING FROM RECIRC TO FRESH)

WITH IGNITION SW TURNED ON, WHEN THE RECIRC/FRESH SW IS SWITCHED TO THE FRESH SIDE, THE CURRENT FLOWS FROM **TERMINAL IG** OF A/C CONTROL ASSEMBLY → **TERMINAL AIF** → **TERMINAL 1** OF AIR INLET CONTROL SERVO MOTOR → **TERMINAL 2** → **TERMINAL AIR** OF A/C CONTROL ASSEMBLY → **TERMINAL GND** → **GROUND**, THE MOTOR ROTATES AND THE DAMPER STOPS AT THAT POSITION.

### 3. OPERATION OF AIR VENT MODE CONTROL SERVO MOTOR

WITH IGNITION SW TURNED ON, THE CURRENT FLOWS FROM **GAUGE FUSE** TO **TERMINAL IG** OF A/C CONTROL ASSEMBLY.

(SWITCHING FROM DEF TO FACE)

THE CURRENT FLOWS FROM **TERMINAL AOF** OF A/C CONTROL ASSEMBLY → **TERMINAL 1** OF AIR VENT CONTROL MODE SERVO MOTOR → **TERMINAL 2** → **TERMINAL AOD** OF A/C CONTROL ASSEMBLY → **TERMINAL GND** → **GROUND**. THE MOTOR ROTATES AND THE DAMPER MOVES TO THE FACE SIDE. WHILE THE DAMPER OPERATES, THE DAMPER POSITION SIGNAL IS INPUT FROM **TERMINAL 5** OF THE SERVO MOTOR TO THE **TERMINAL TPO** OF THE ECU (BUILT INTO THE A/C CONTROL ASSEMBLY). AS A RESULT, CURRENT TO THE SERVO MOTOR CIRCUIT IS CUT OFF BY THE ECU, SO THE DAMPER STOPS AT THAT POSITION.

(SWITCHING FROM FACE TO DEF)

THE CURRENT FLOWS FROM **TERMINAL AOD** OF A/C CONTROL ASSEMBLY → **TERMINAL 2** OF AIR VENT MODE CONTROL SERVO MOTOR → **TERMINAL 1** → **TERMINAL AOF** OF A/C CONTROL ASSEMBLY → **TERMINAL GND** → **GROUND**, THE MOTOR ROTATES AND THE DAMPER STOPS AT THAT POSITION.

### 4. OPERATION OF AIR MIX CONTROL SERVO MOTOR

WHEN THE TEMPERATURE SW IS TURNED TO THE 'COOL' SIDE, THE CURRENT FLOWS FROM **TERMINAL AMC** OF A/C CONTROL ASSEMBLY → **TERMINAL 1** OF AIR MIX CONTROL SERVO MOTOR → MOTOR → **TERMINAL 2** → **TERMINAL AMH** OF A/C CONTROL ASSEMBLY → **GROUND** AND THE MOTOR ROTATES. THE DAMPER OPENING ANGLE AT THIS TIME IS INPUT FROM **TERMINAL 5** OF SERVO MOTOR TO **TERMINAL TP** OF A/C CONTROL ASSEMBLY, THIS IS USED TO DETERMINE THE DAMPER STOP POSITION AND MAINTAIN THE SET TEMPERATURE.

WHEN THE TEMPERATURE CONTROL SW IS TURNED TO THE "WARM" SIDE, THE CURRENT FLOWS FROM SERVO MOTOR → **TERMINAL AMH** OF A/C CONTROL ASSEMBLY → **TERMINAL 2** OF AIR MIX CONTROL SERVO MOTOR → MOTOR → **TERMINAL 1** → **TERMINAL AMC** OF A/C CONTROL ASSEMBLY, ROTATING THE MOTOR IN REVERSE AND SWITCHING THE DAMPER FROM COOL TO WARM SIDE.

### 5. OPERATION OF AIR MIX CONTROL SERVO MOTOR

WHEN THE MODE SW IS SET TO BI-LEVEL, CURRENT FLOWS FROM THE **GAUGE FUSE** TO **TERMINAL 4** OF MAX COOL CONTROL SERVO MOTOR → **TERMINAL 1** → **TERMINAL CBLO** OF A/C CONTROL ASSEMBLY → **TERMINAL GND** → **GROUND**. THIS OPERATES THE MOTOR TO SET THE DAMPER TO THE MAX COOL SIDE.

## 6. AIR CONDITIONING OPERATION

THE A/C CONTROL ASSEMBLY RECEIVES VARIOUS SIGNALS, I.E., THE ENGINE RPM FROM THE IGNITER, OUTLET TEMPERATURE SIGNAL FROM THE A/C THERMISTOR, COOLANT TEMPERATURE FROM THE ENGINE COOLANT TEMP. SENSOR (WATER TEMP. SENSOR) AND THE LOCK SIGNAL FROM THE A/C COMPRESSOR, ETC.

WHEN THE ENGINE IS STARTED AND THE A/C SW (A/C CONTROL ASSEMBLY) IS ON, A SIGNAL IS INPUT TO THE ECU (BUILT IN THE A/C CONTROL ASSEMBLY). AS A RESULT, THE GROUND CIRCUIT IN A/C CONTROL ASSEMBLY IS CLOSED AND CURRENT FLOWS FROM **GAUGE** TO **TERMINAL 1** OF A/C MAGNETIC CLUTCH RELAY → **TERMINAL 2** → **TERMINAL ACMG** OF ENGINE CONTROL MODULE (ENGINE AND ELECTRONICALLY CONTROLLED TRANSMISSION ECU) → **TERMINAL A/C** → **TERMINAL MGC** OF A/C LOCK AMPLIFIER → **TERMINAL 7** → **TERMINAL MGC** OF A/C CONTROL ASSEMBLY → **TERMINAL GND** → **GROUND**, TURNING THE RELAY ON, SO THAT THE A/C MAGNETIC CLUTCH IS ON AND THE A/C COMPRESSOR OPERATES.

AT THE SAME TIME, THE ENGINE CONTROL MODULE (ENGINE AND ELECTRONICALLY CONTROLLED TRANSMISSION ECU) DETECTS THE MAGNETIC CLUTCH IS ON AND THE A/C COMPRESSOR OPERATES. OPEN DIRECTION TO AVOID LOWERING THE ENGINE RPM DURING A/C OPERATING.

WHEN ANY OF THE FOLLOWING SIGNALS ARE INPUT TO THE A/C CONTROL ASSEMBLY, THE CONTROL ASSEMBLY OPERATES TO TURN OFF THE AIR CONDITIONING.

- \* ENGINE TEMP. SIGNAL IS HIGH.
- \* COOLANT TEMP. SIGNAL IS HIGH.
- \* A SIGNAL THAT THE TEMPERATURE AT THE AIR OUTLET IS LOW.
- \* A SIGNAL THAT THERE IS A LARGE DIFFERENCE BETWEEN ENGINE SPEED AND COMPRESSOR SPEED.
- \* A SIGNAL THAT THE REFRIGERANT PRESSURE IS ABNORMALLY HIGH OR LOW.

## SERVICE HINTS

### A 3 A/C LOCK SENSOR AND A/C MAGNETIC CLUTCH

4-GROUND: APPROX. 3.7

### A 2 A/C DUAL PRESSURE SW [A/C TRIPLE PRESSURE SW]

1-4 : OPEN ABOVE APPROX. 206 KPA (30 PSI, 15.5 KG/CM<sup>2</sup>) OR 2648 KPA (384 PSI, 27 KG/CM<sup>2</sup>)

### A 8, A 9, A10 A/C CONTROL ASSEMBLY

- +B – GROUND: ALWAYS APPROX. 10–14 VOLTS
- IG – GROUND: APPROX. 10–14 VOLTS WITH IGNITION SW AT **ON** POSITION
- HR – GROUND: APPROX. 10–14 VOLTS WITH IGNITION SW AT **ON** POSITION AND DO NOT TURN THE BLOWER MOTOR BELOW 1 VOLTS WITH IGNITION SW AT **ON** POSITION AND TURN THE BLOWER MOTOR
- ACC – GROUND: APPROX. 10–14 VOLTS WITH IGNITION SW AT **ACC** OR **ON** POSITION
- TW – GROUND: 10–14 VOLTS AT START THE ENGINE AND MAX. COLD POSITION OF A/C TEMP. CONTROL SW BELOW 1 VOLTS AT START THE ENGINE AND MAX. WARM POSITION OF A/C TEMP. CONTROL SW
- MGC – GROUND: BELOW 1 VOLTS AT START THE ENGINE, PUSH THE A/C AUTO SW AND A/C SW **ON** POSITION 10–14 VOLTS AT START THE ENGINE, PUSH THE A/C AUTO SW AND A/C SW **OFF** POSITION
- BLW – GROUND: 1.0–3.0 VOLTS WITH THE IGNITION SW ON AND TURN THE BLOWER MOTOR
- S5 – GROUND: 4–6 VOLTS WITH THE IGNITION SW ON
- SG – GROUND: ALWAYS CONTINUITY
- AMH – AMC: 13–19 VOLTS WITH IGNITION SW OFF
- AIF – GROUND: APPROX. 12 VOLTS WITH FRESH SW ON
- AIR – GROUND: APPROX. 12 VOLTS WITH RECIRC SW ON
- AOF – GROUND: APPROX. 12 VOLTS WITH FACE SW ON
- AOD – GROUND: APPROX. 12 VOLTS WITH DEF SW ON
- GND – GROUND: ALWAYS CONTINUITY

# RADIATOR FAN AND AUTOMATIC AIR CONDITIONING

FROM POWER SOURCE SYSTEM (SEE PAGE 58)

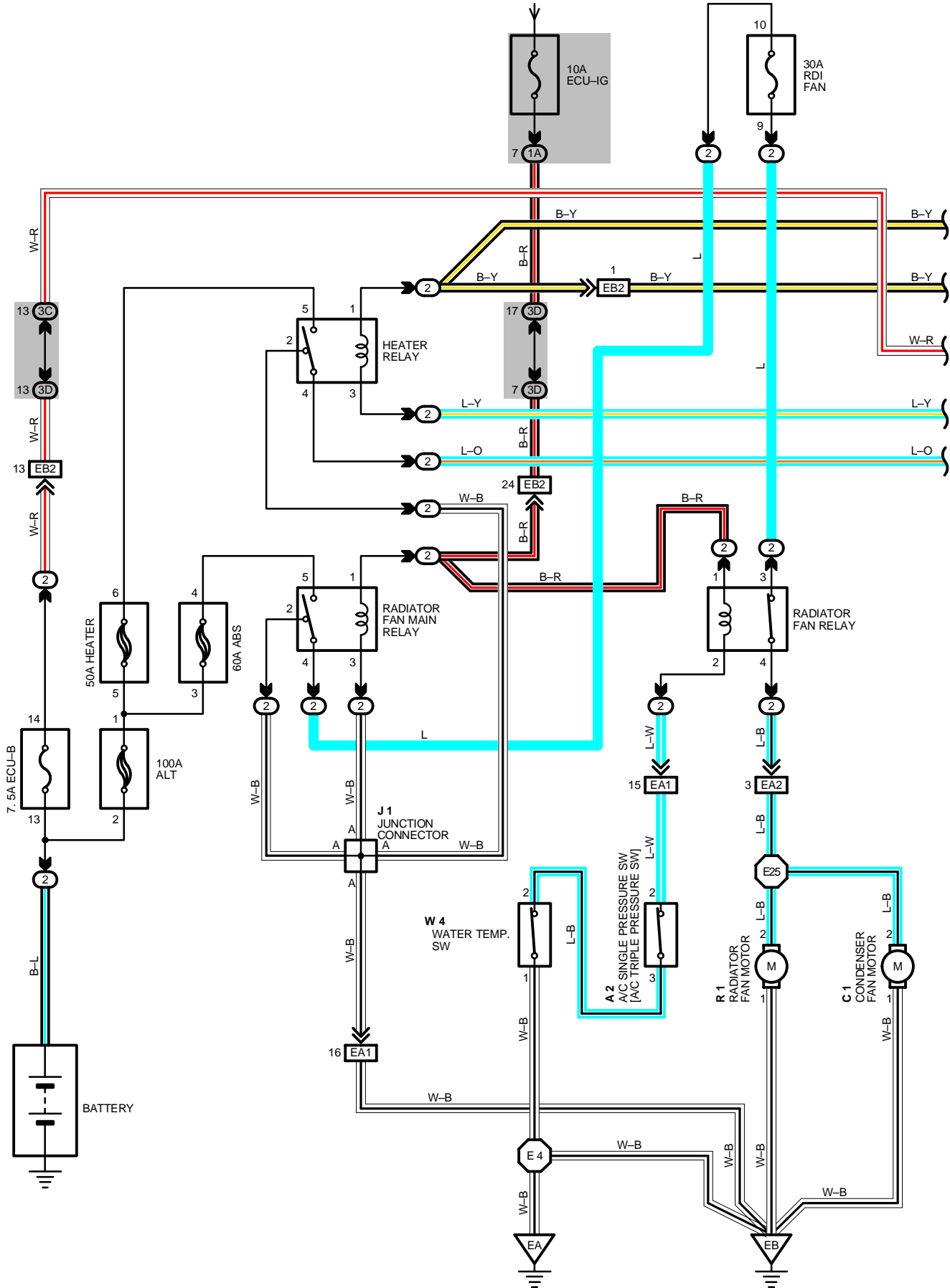

FROM POWER SOURCE SYSTEM (SEE PAGE 58)

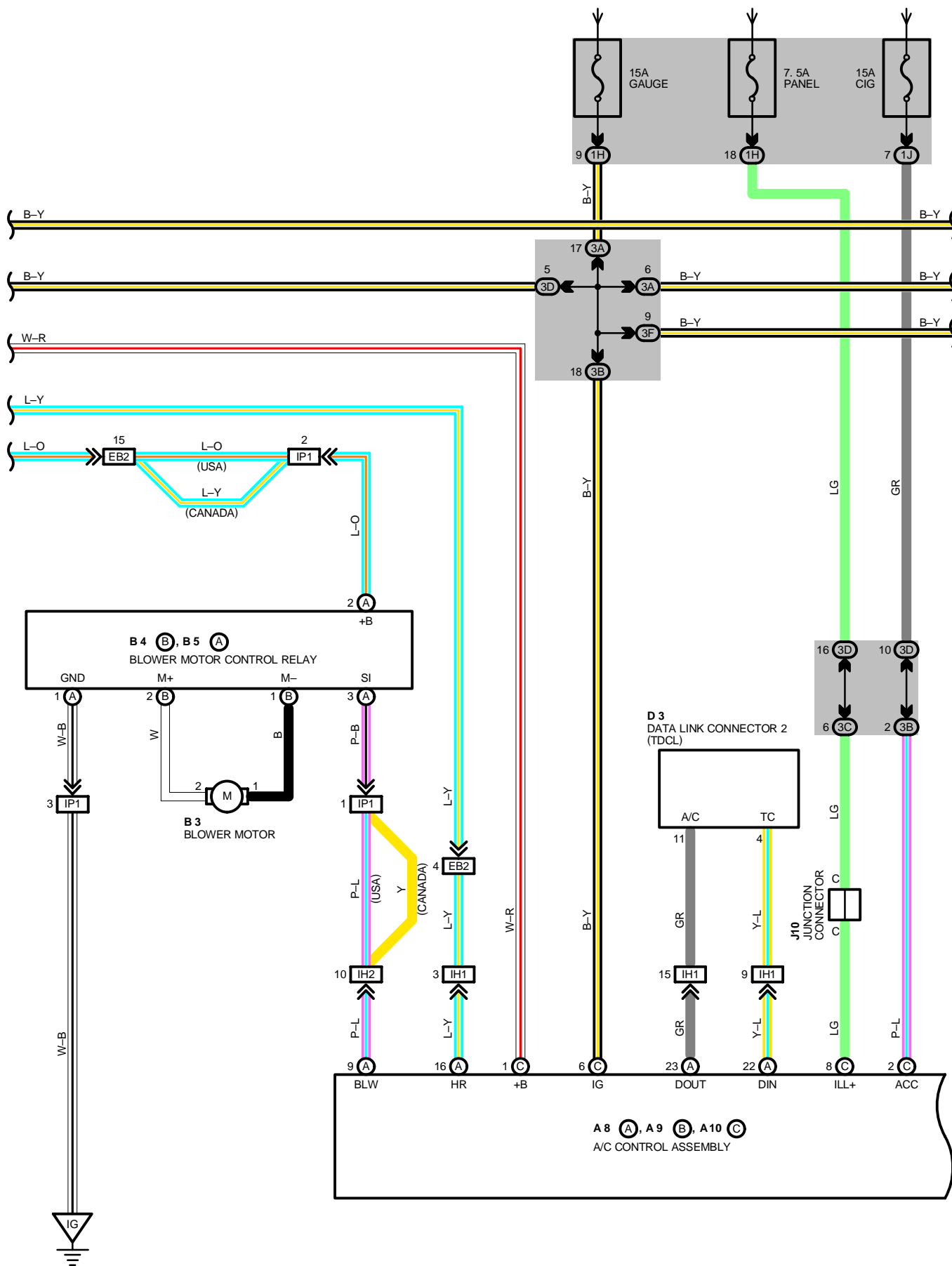

# RADIATOR FAN AND AUTOMATIC AIR CONDITIONING

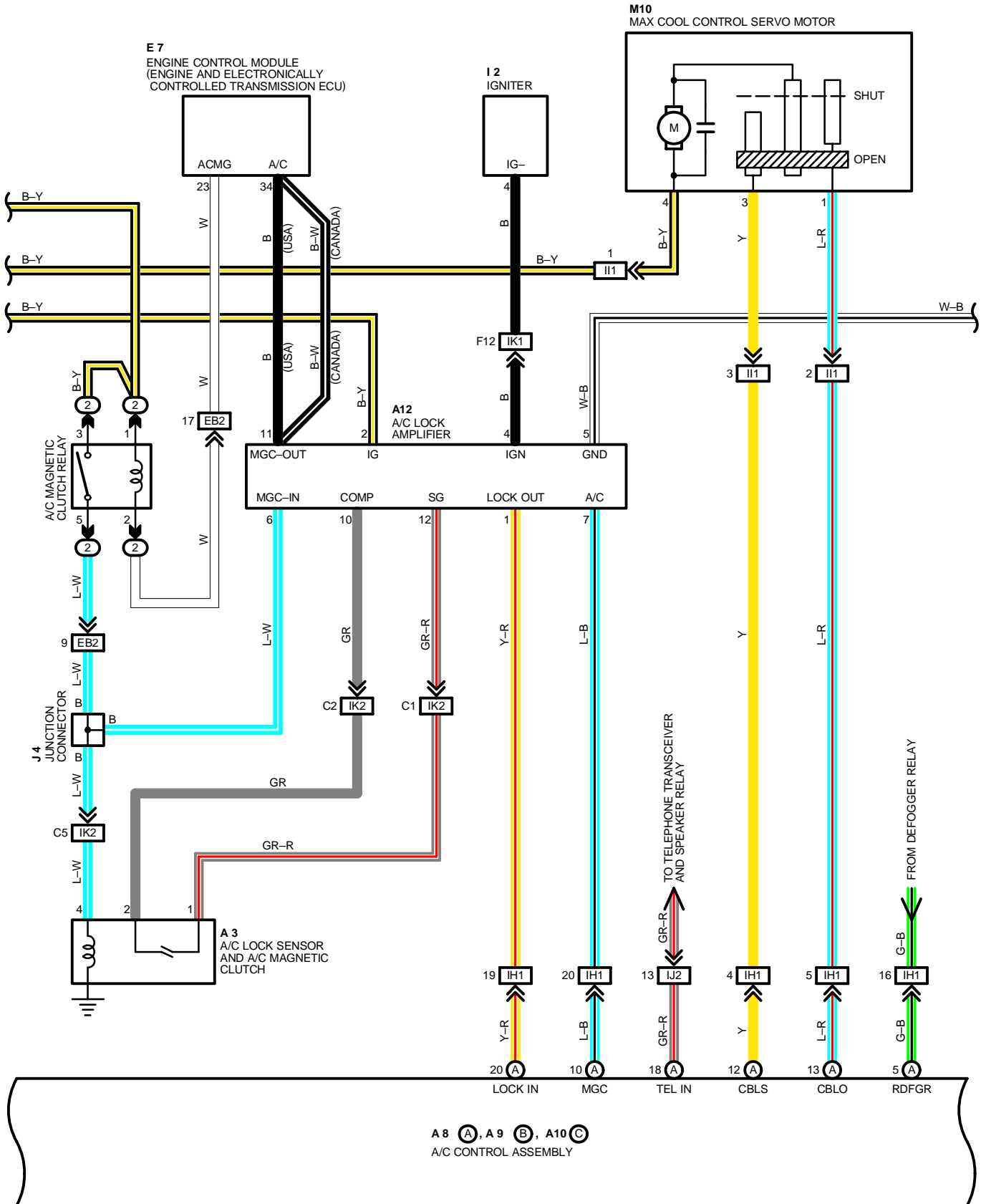

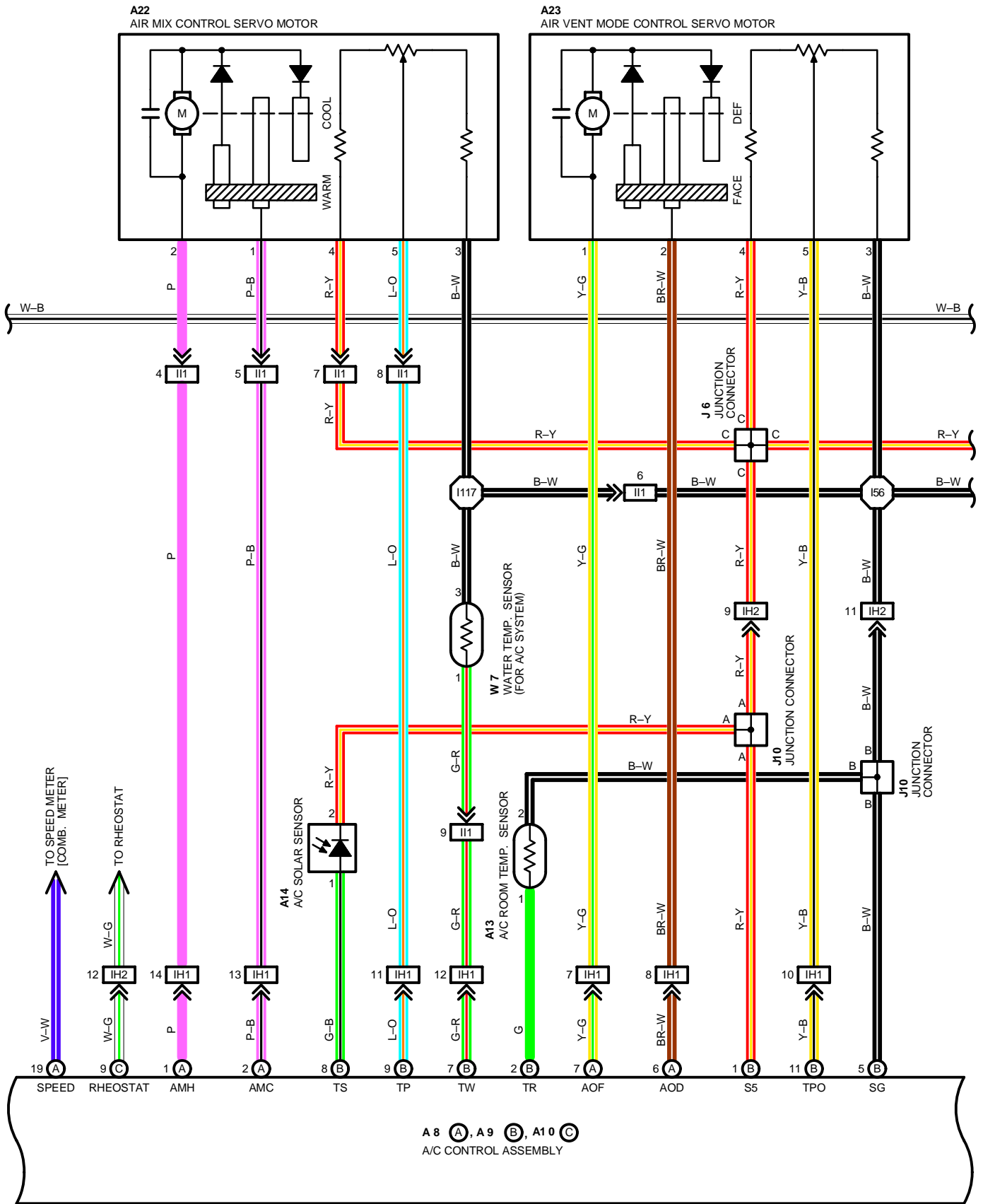

# RADIATOR FAN AND AUTOMATIC AIR CONDITIONING

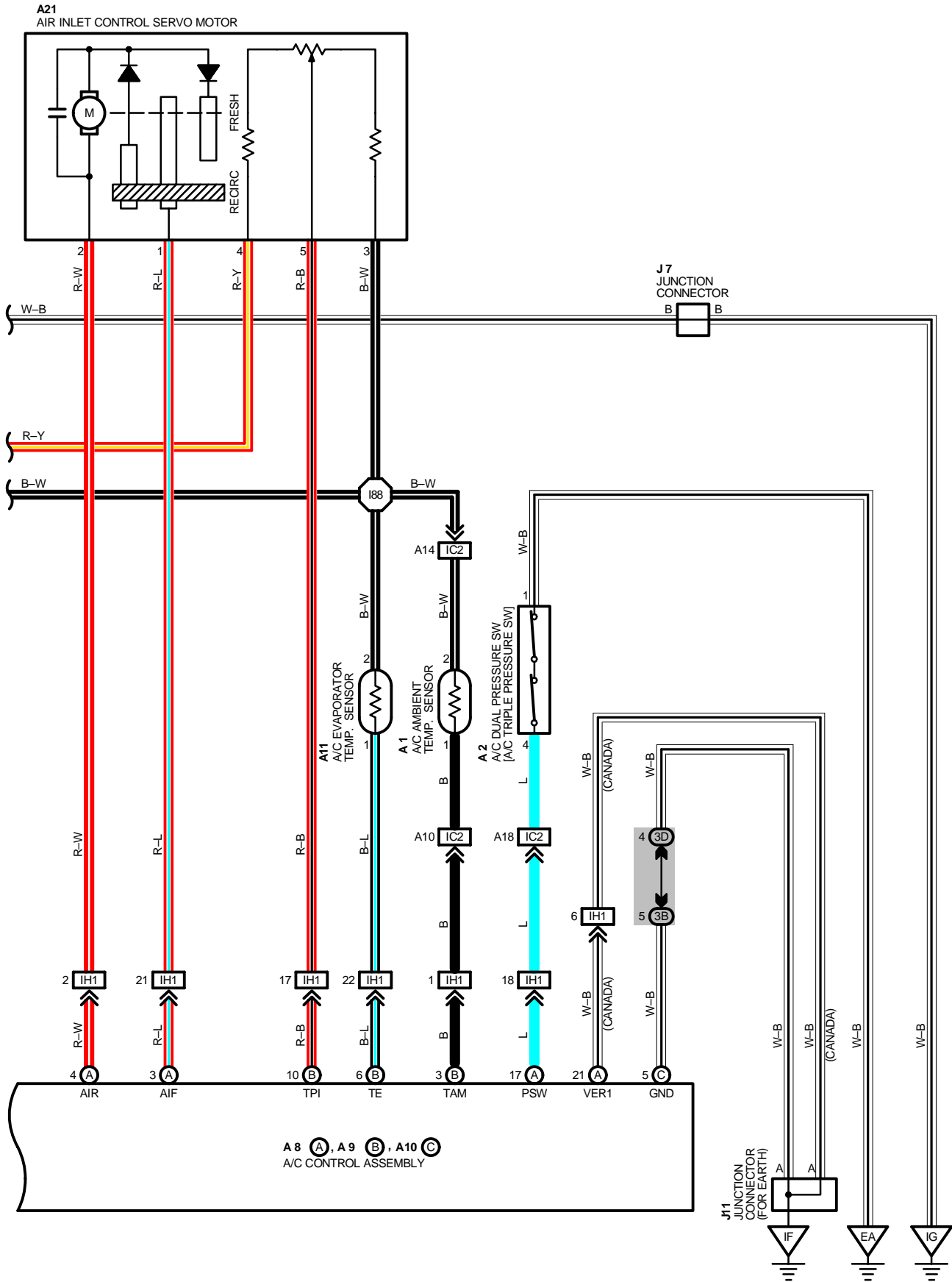



**○ : PARTS LOCATION**

CODE	SEE PAGE	CODE	SEE PAGE	CODE	SEE PAGE
A 1	26	A21	28	J 1	27
A 2	26	A22	28	J 4	29
A 3	26	A23	28	J 6	29
A 8	A 28	B 3	28	J 7	29
A 9	B 28	B 4	B 28	J10	29
A10	C 28	B 5	A 28	J11	29
A11	28	C 1	28	M10	29
A12	28	D 3	28	R 1	27
A13	28	E 7	28	W 4	27
A14	28	I 2	26	W 7	29

**○ : RELAY BLOCKS**

CODE	SEE PAGE	RELAY BLOCKS (RELAY BLOCK LOCATION)
2	19	R/B NO. 2 (ENGINE COMPARTMENT LEFT)

**○ : JUNCTION BLOCK AND WIRE HARNESS CONNECTOR**

CODE	SEE PAGE	JUNCTION BLOCK AND WIRE HARNESS (CONNECTOR LOCATION)
1A	20	COWL WIRE AND J/B NO. 1 (LEFT KICK PANEL)
1H		
1J		
3A	22	COWL WIRE AND J/B NO. 3 (BEHIND THE INSTRUMENT PANEL CENTER)
3B	22	INSTRUMENT PANEL WIRE AND J/B NO. 3 (BEHIND THE INSTRUMENT PANEL CENTER)
3C		
3D		
3F	22	COWL WIRE AND J/B NO. 3 (BEHIND THE INSTRUMENT PANEL CENTER)

**□ : CONNECTOR JOINING WIRE HARNESS AND WIRE HARNESS**

CODE	SEE PAGE	JOINING WIRE HARNESS AND WIRE HARNESS (CONNECTOR LOCATION)
EA1	34	ENGINE ROOM MAIN WIRE AND R/B NO. 2 WIRE (INSIDE OF R/B NO. 2)
EA2		
EB2	34	COWL WIRE AND R/B NO. 2 WIRE (INSIDE OF R/B NO. 2)
IC2	36	ENGINE ROOM MAIN WIRE AND COWL WIRE (UNDER THE GLOVE BOX)
IH1	36	COWL WIRE AND INSTRUMENT PANEL WIRE (BEHIND GLOVE BOX)
IH2		
II1	36	COWL WIRE AND A/C SUB NO. 1 WIRE (INSTRUMENT PANEL CENTER)
IJ2	36	INSTRUMENT PANEL WIRE AND FLOOR NO. 1 WIRE (UNDER THE INSTRUMENT PANEL BRACE LH)
IK1	38	ENGINE WIRE AND COWL WIRE (UNDER THE GLOVE BOX)
IK2		
IP1	38	COWL WIRE AND A/C SUB NO. 2 WIRE (BEHIND GLOVE BOX)

**▽ : GROUND POINTS**

CODE	SEE PAGE	GROUND POINTS LOCATION
EA	34	FRONT SIDE OF RIGHT FENDER
EB	34	FRONT SIDE OF LEFT FENDER
IF	36	BEHIND COMBINATION METER
IG	36	BEHIND GLOVE BOX

**○ : SPLICE POINTS**

CODE	SEE PAGE	WIRE HARNESS WITH SPLICE POINTS	CODE	SEE PAGE	WIRE HARNESS WITH SPLICE POINTS
E 4	34	ENGINE ROOM MAIN WIRE	I88	38	COWL WIRE
E25			I117	38	A/C NO. 1 WIRE
I56	38	COWL WIRE			

A 1 BLACK



A 2 BLACK

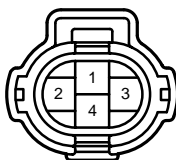

A 3 GRAY



(USA) A 8 A

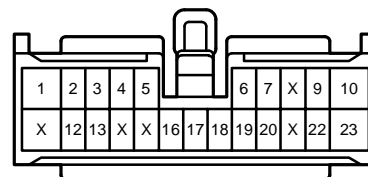

# RADIATOR FAN AND AUTOMATIC AIR CONDITIONING

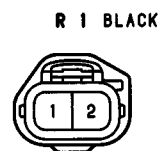
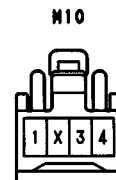
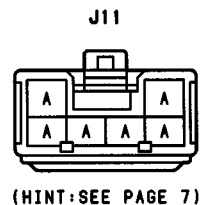
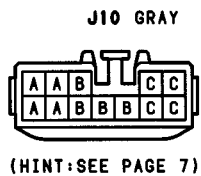
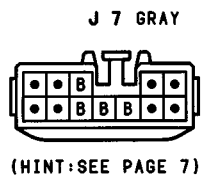
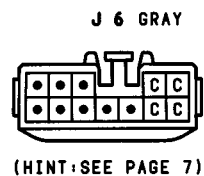
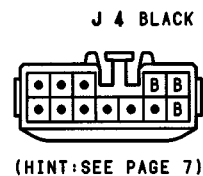
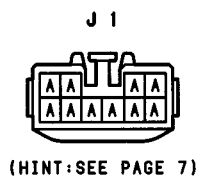
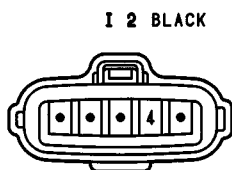
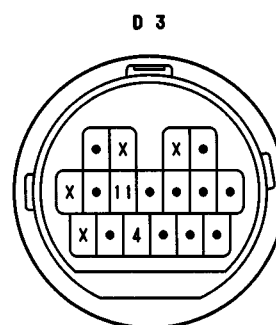
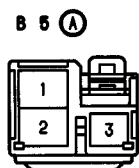
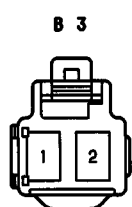
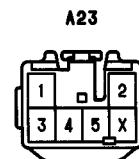
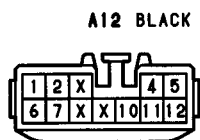
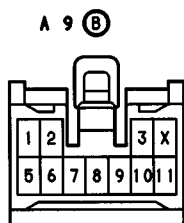
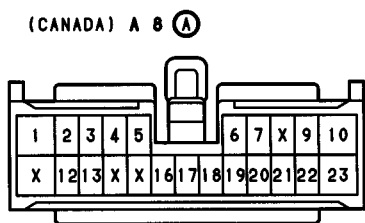

---

# GROUND POINT

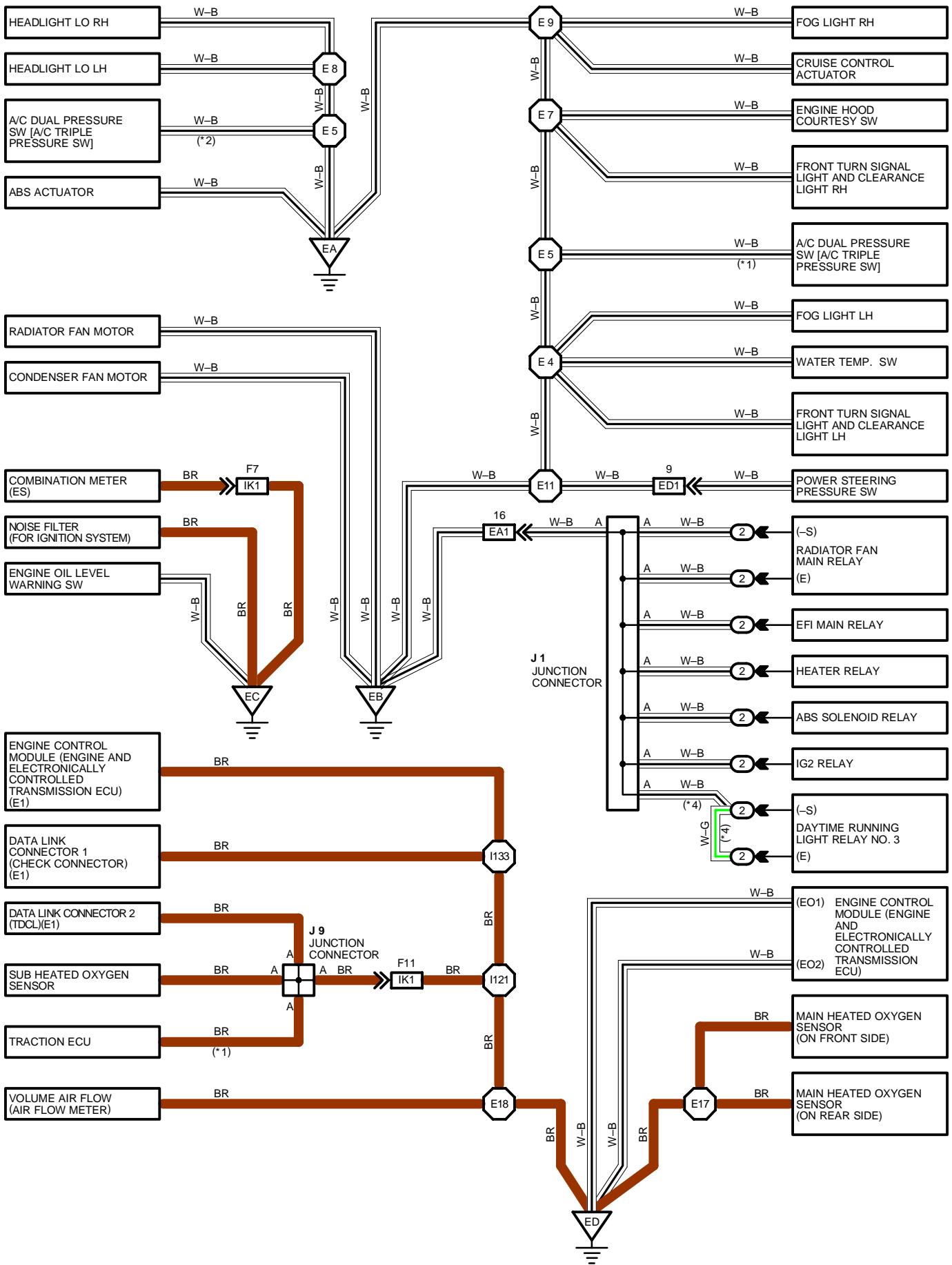

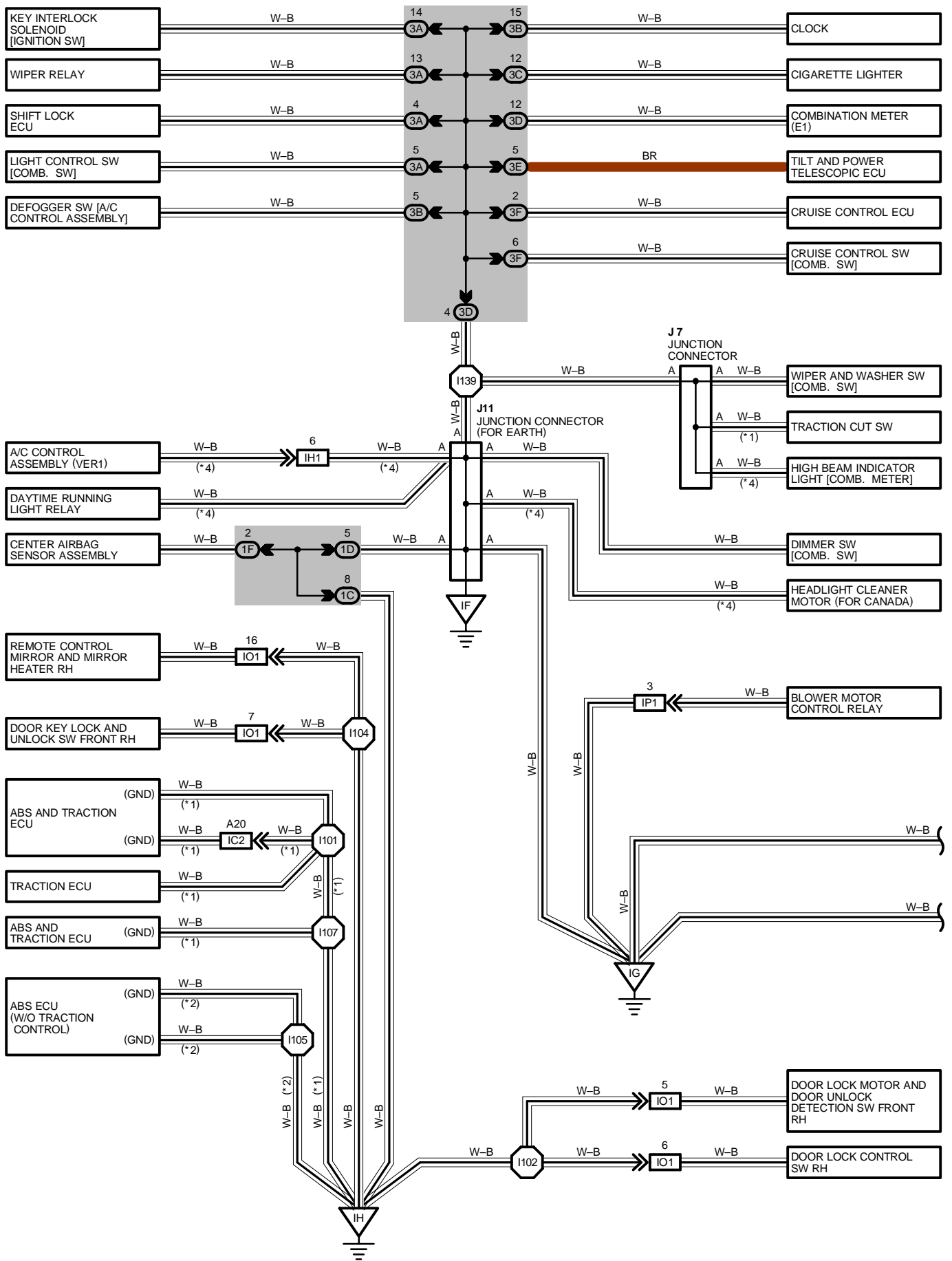



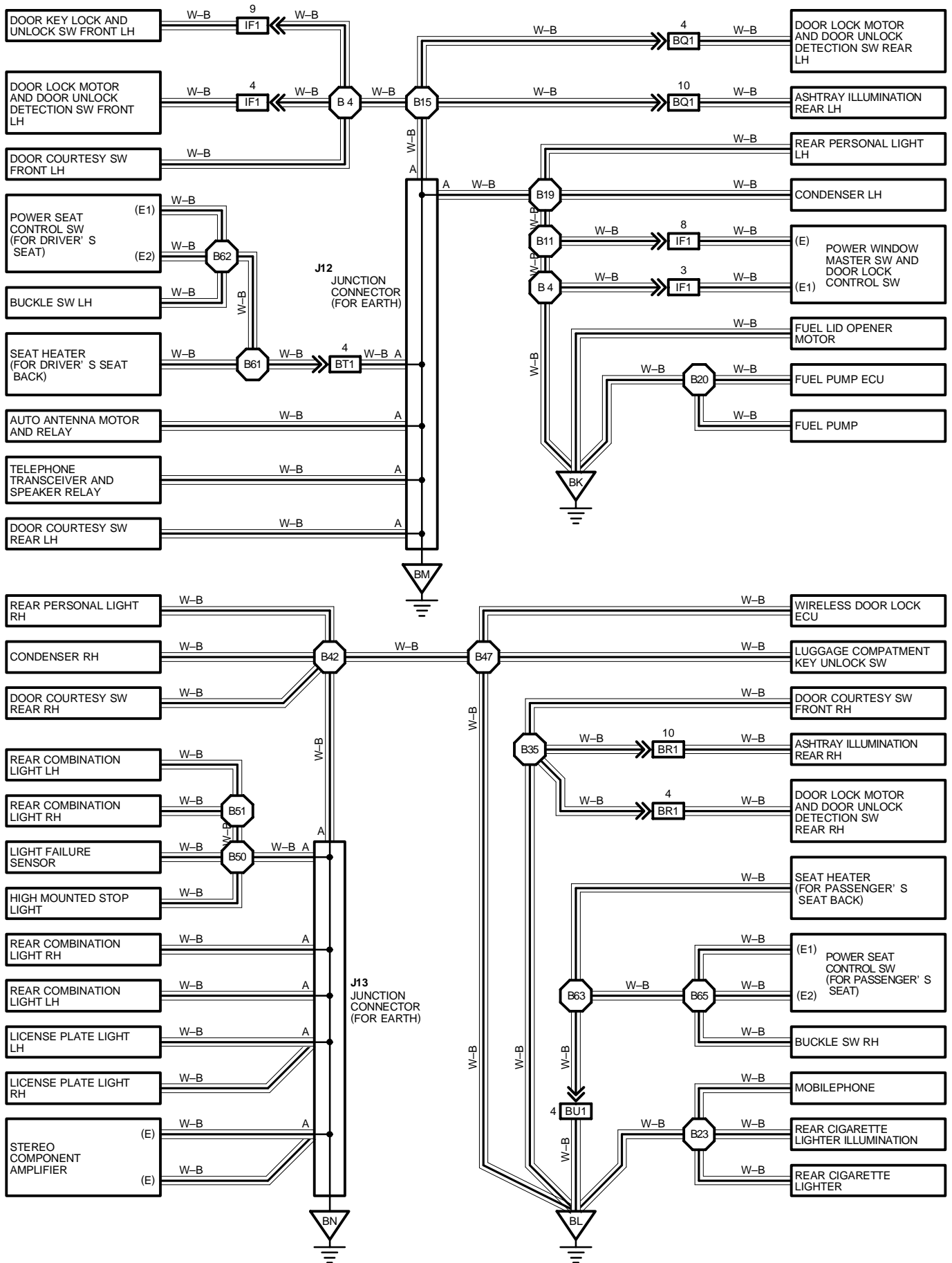

# GROUND POINT

## ○ : PARTS LOCATION

CODE	SEE PAGE	CODE	SEE PAGE	CODE	SEE PAGE
J 1	27	J 9	29	J13	30
J 2	29	J11	29		
J 7	29	J12	30		

## ○ : RELAY BLOCKS

CODE	SEE PAGE	RELAY BLOCKS (RELAY BLOCK LOCATION)
2	19	R/B NO. 2 (ENGINE COMPARTMENT LEFT)
6	24	R/B NO.6 (LEFT KICK PANEL)

## ○ : JUNCTION BLOCK AND WIRE HARNESS CONNECTOR

CODE	SEE PAGE	JUNCTION BLOCK AND WIRE HARNESS (CONNECTOR LOCATION)
1C	20	COWL WIRE AND J/B NO. 1 (LEFT KICK PANEL)
1D		
1F		
1G		
3A	22	COWL WIRE AND J/B NO. 3 (BEHIND THE INSTRUMENT PANEL CENTER)
3B	22	INSTRUMENT PANEL WIRE AND J/B NO. 3 (BEHIND THE INSTRUMENT PANEL CENTER)
3C		
3D	22	COWL WIRE AND J/B NO. 3 (BEHIND THE INSTRUMENT PANEL CENTER)
3E		
3F		

## □ : CONNECTOR JOINING WIRE HARNESS AND WIRE HARNESS

CODE	SEE PAGE	JOINING WIRE HARNESS AND WIRE HARNESS (CONNECTOR LOCATION)
EA1	34	ENGINE ROOM MAIN WIRE AND R/B NO. 2 WIRE (INSIDE OF R/B NO. 2)
ED1	34	ENGINE ROOM MAIN WIRE AND ENGINE NO. 4 WIRE (NEAR THE R/B NO. 2)
IC2	36	ENGINE ROOM MAIN WIRE AND COWL WIRE (UNDER THE GLOVE BOX)
IF1	36	FRONT DOOR LH WIRE AND FLOOR NO. 2 WIRE (LEFT KICK PANEL)
IG2	36	FRONT DOOR LH WIRE AND COWL WIRE (LEFT KICK PANEL)
IH1	36	COWL WIRE AND INSTRUMENT PANEL WIRE (BEHIND GLOVE BOX)
IK1	38	ENGINE WIRE AND COWL WIRE (UNDER THE GLOVE BOX)
IL1	38	COWL WIRE AND ROOF WIRE (BEHIND GLOVE BOX)
IO1	38	FRONT DOOR RH WIRE AND COWL WIRE (RIGHT KICK PANEL)
IP1	38	COWL WIRE AND A/C SUB NO. 2 WIRE (BEHIND GLOVE BOX)
BQ1	40	REAR DOOR LH WIRE AND FLOOR NO. 2 WIRE (LEFT CENTER PILLAR)
BR1	40	REAR DOOR RH WIRE AND FLOOR NO. 1 WIRE (RIGHT CENTER PILLAR)
BT1	42	FLOOR NO. 2 WIRE AND FRONT SEAT LH WIRE (UNDER THE FRONT LH SEAT)
BU1	42	FLOOR NO. 1 WIRE AND FRONT SEAT RH WIRE (UNDER THE FRONT RH SEAT)

## ▽ : GROUND POINTS

CODE	SEE PAGE	GROUND POINTS LOCATION
EA	34	FRONT SIDE OF RIGHT FENDER
EB	34	FRONT SIDE OF LEFT FENDER
EC	34	FRONT SIDE OF INTAKE MANIFOLD
ED	34	REAR SIDE OF INTAKE MANIFOLD
IE	36	LEFT KICK PANEL
IF	36	BEHIND COMBINATION METER
IG	36	BEHIND GLOVE BOX
IH	36	RIGHT KICK PANEL
II	36	INSTRUMENT PANEL BRACE LH
BJ	40	FRONT SIDE OF ROOF CENTER
BK	40	UNDER THE FRONT SEAT LH
BL	40	UNDER THE FRONT SEAT RH
BM	40	LUGGAGE ROOM LEFT
BN	40	LUGGAGE ROOM RIGHT
BO	40	LEFT SIDE OF REAR PILLAR





**: SPLICE POINTS**

CODE	SEE PAGE	WIRE HARNESS WITH SPLICE POINTS	CODE	SEE PAGE	WIRE HARNESS WITH SPLICE POINTS		
E 4	34	ENGINE ROOM MAIN WIRE	I133	38	ENGINE WIRE		
E 5			I138		38	COWL WIRE	
E 7			I139				
E 8			I142				
E 9			B 2	40	ROOF WIRE		
E11			B 3				
E17	34	ENGINE WIRE	B 4	40	FLOOR NO. 2 WIRE		
E18			B11				
I 3	38	COWL WIRE	B15			40	FLOOR NO. 1 WIRE
I30			B19				
I55			B20				
I60			B23				
I67			B35	40	FLOOR NO. 1 WIRE		
I68			B42				
I69			B47				
I101			B50				
I102			B51	42	FRONT SEAT LH WIRE		
I104			B61				
I105			B62				
I107			B63	42	FRONT SEAT RH WIRE		
I121			B65				

**J 1**



(HINT:SEE PAGE 7)

**J 2**

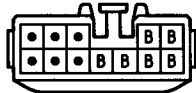

(HINT:SEE PAGE 7)

**J 7 GRAY**

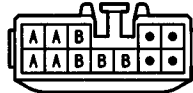

(HINT:SEE PAGE 7)

**J 9 GRAY**

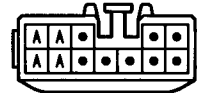

(HINT:SEE PAGE 7)

**J11**

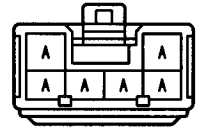

(HINT:SEE PAGE 7)

**J12**

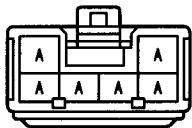

(HINT:SEE PAGE 7)

**J13**

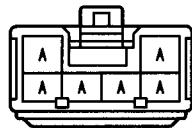

(HINT:SEE PAGE 7)

# HOW TO USE THIS MANUAL

\* The system shown here is an EXAMPLE ONLY. It is different to the actual circuit shown in the wiring diagram section.

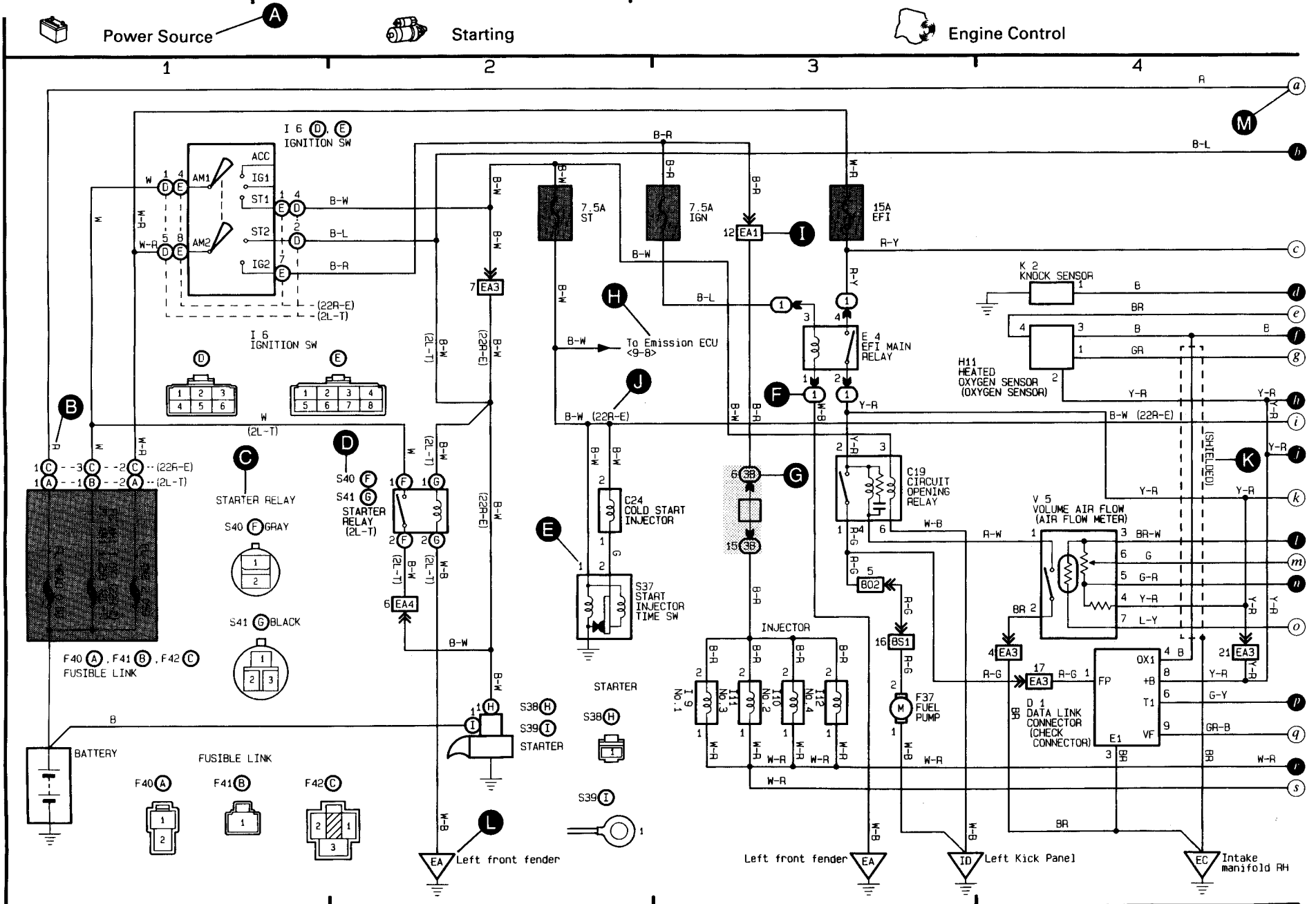

**A:** System Title

**B:** Indicates the wiring color.

Wire colors are indicated by an alphabetical code.

B = Black    L = Blue    R = Red  
BR = Brown    LG = Light Green    V = Violet  
G = Green    O = Orange    W = White  
GR = Gray    P = Pink    Y = Yellow

The first letter indicates the basic wire color and the second letter indicates the color of the stripe.

**Example:** L - Y

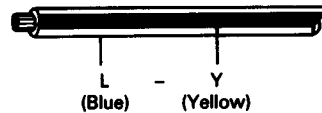

**C:** Indicates the connector to be connected to a part (the numeral indicates the pin No.)

**D:** The position of the parts is the same as shown in the wiring diagram and wire routing.

**E:** Indicates the pin number of the connector. The numbering system is different for female and male connectors.

**Example:** Numbered in order from upper left to lower right



Female

Numbered in order from upper right to lower left

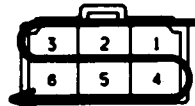

Male

The numbering system for the overall wiring diagram is the same as above.

**F:** Indicates a Relay Block. No Shading is used and only the Relay Block No. is shown to distinguish it from the J/B.

**Example:** **1** Indicates Relay Block No. 1.

**G:** Junction Block (The number in the circle is the J/B No. and connector code is shown beside it). Junction Blocks are shaded to clearly separate them from other parts (different junction blocks are shaded differently for further clarification).

Example:



**3B** indicates that it is inside Junction Block No. 3.

**H:** Indicates related system.

**I:** Indicates the wiring harness and wiring harness connector. The wiring harness with male terminal is shown with arrows (↘).

Outside numerals are pin numbers.

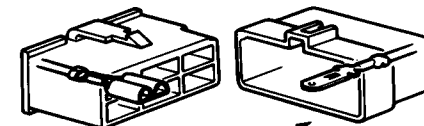

Female

Male (↘)

**J:** ( ) is used to indicate different wiring and connector, etc. when the vehicle model, engine type, or specification is different.

**K:** Indicates a shielded cable.



**L:** Indicates and located on ground point.

**M:** The same code occurring on the next page indicates that the wire harness is continuous.

## SYSTEM INDEX

SYSTEMS	LOCATION	SYSTEMS	LOCATION	SYSTEMS	LOCATION
ABS (Anti-Lock Brake System)	18-2	Headlight Cleaner (for Canada)	5-2	Remote Control Mirror	11-3
ABS and Traction Control	19-2	Horn	15-3	Seat Heater	15-2
Auto Antenna	23-2	Ignition	1-3	Shift Lock	16-2
Automatic Light Control	5-3	Illumination	8-2	SRS (Supplemental Restraint System)	16-3
Back-Up Light	17-8	Interior Light	7-3	Starting	1-2
Cellular Mobile Telephone	22-2	Light Auto Turn Off	3-2	Taillight and Stop Light	6-2
Charging	1-4	Luggage and Fuel Lid Opener	7-7	Theft Deterrent and Door Lock Control	12-2
Cigarette Lighter	15-3	Moon Roof	10-2	Turn signal and Hazard Warning Light	9-4
Clock	15-4	Power Seat	14-2	Unlock and Seat Belt Warning	7-2
Combination Meter	24-2	Power Source	1~25-1	Wiper and Washer	21-2
Cruise Control	20-2	Power Window	10-3	Wireless Door Lock Control	12-8
Electric Tension Reducer	7-6	PPS (Progressive Power Steering)	16-2		
Electronically Controlled Transmission and A/T Indicator	17-2	Radiator Fan and Automatic Air Conditioning	25-2		
Engine Control	2-2	Radio and Player	23-2		
Front Fog Light	9-2	Rear Window Defogger and Mirror Heater	11-2		
Headlight	3-3 (for USA) 4-2 (for Canada)				

---

# 1995 GS 300 Overall Electrical Wiring Diagram

## 1 LEXUS GS300 ELECTRICAL WIRING DIAGRAM

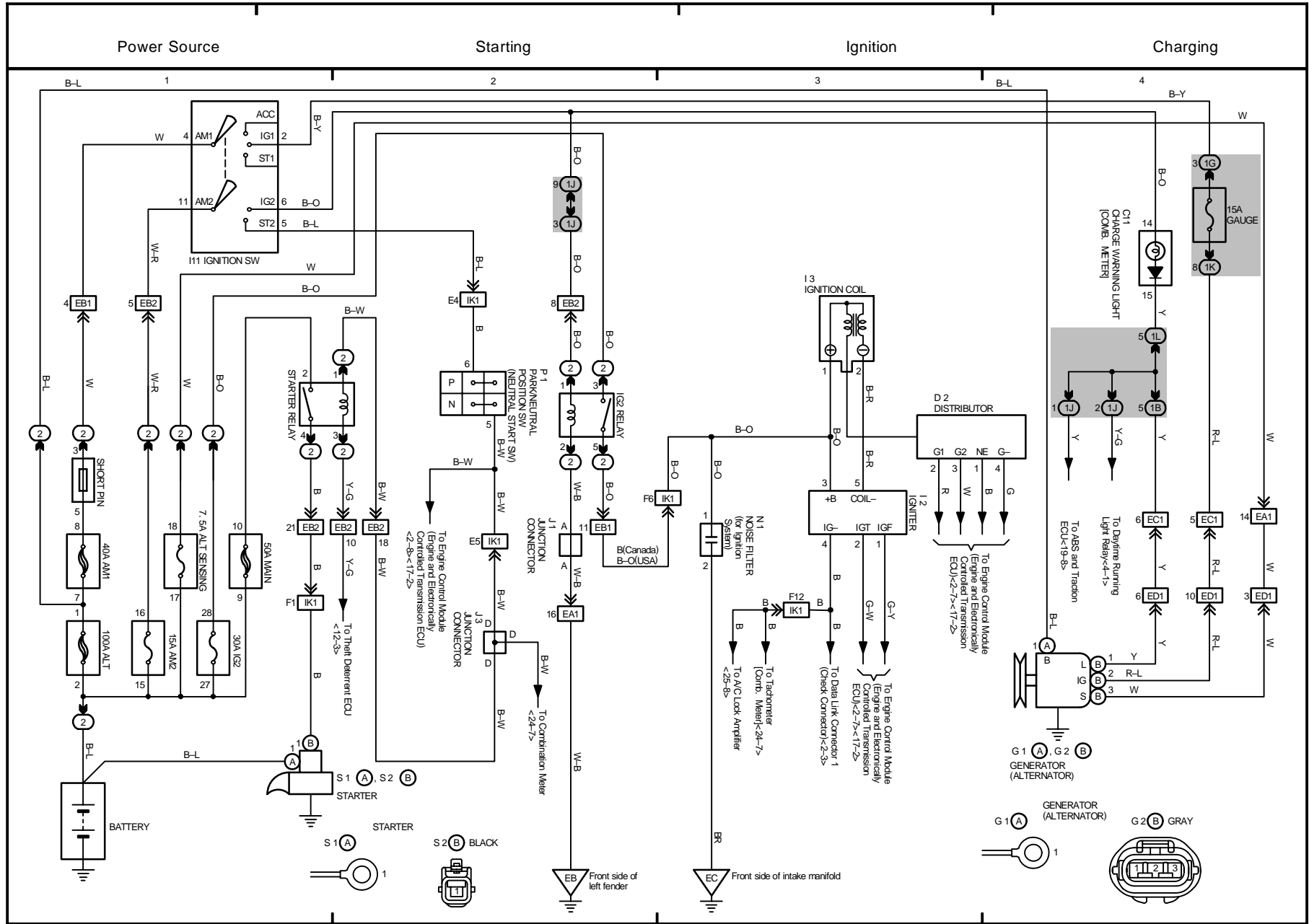



2 LEXUS GS300(Cont' d)

Engine Control

- \*1: w/ Traction Control
- \*2: w/o Traction Control
- \*3: Canada
- \*4: USA

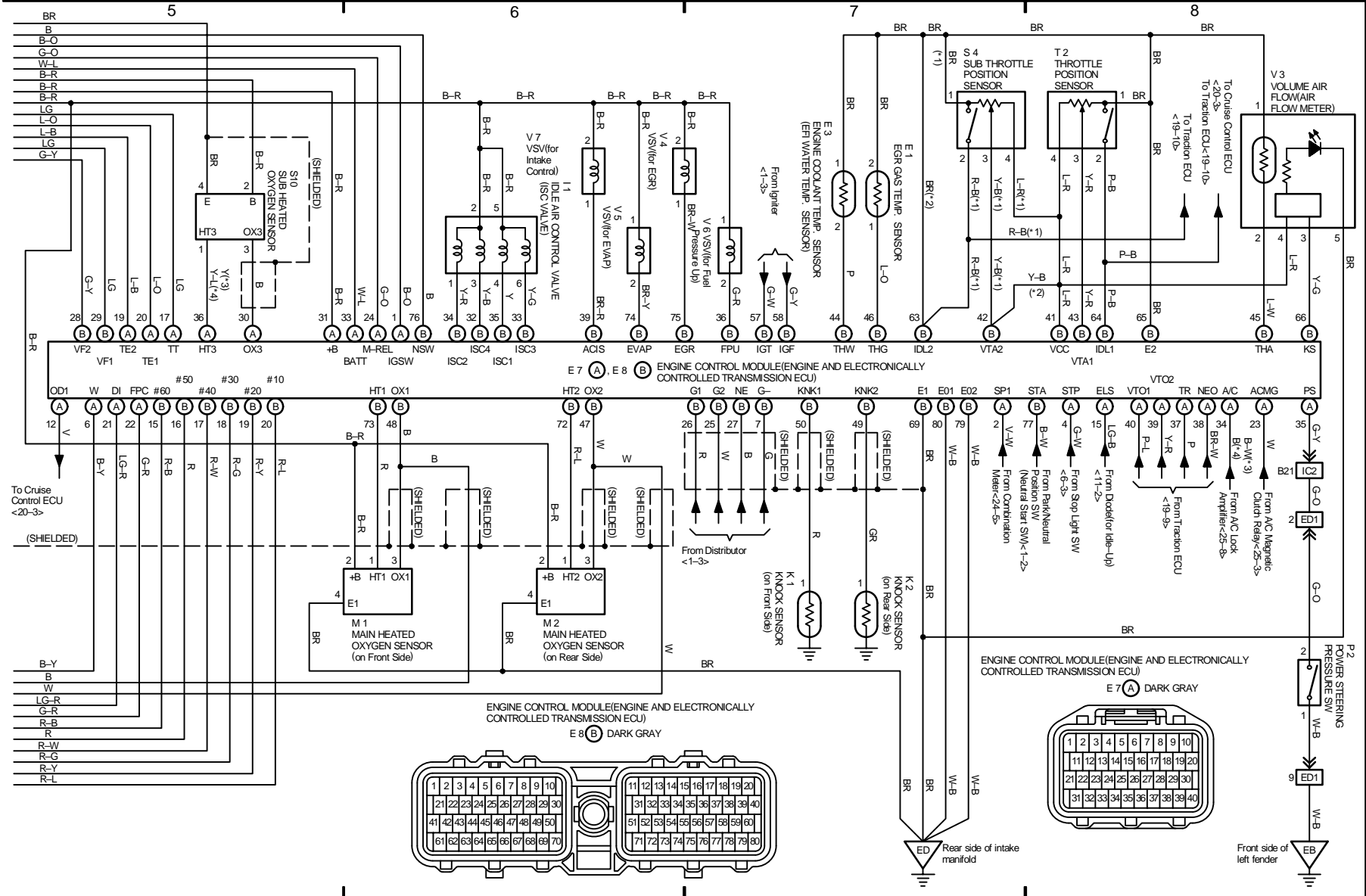



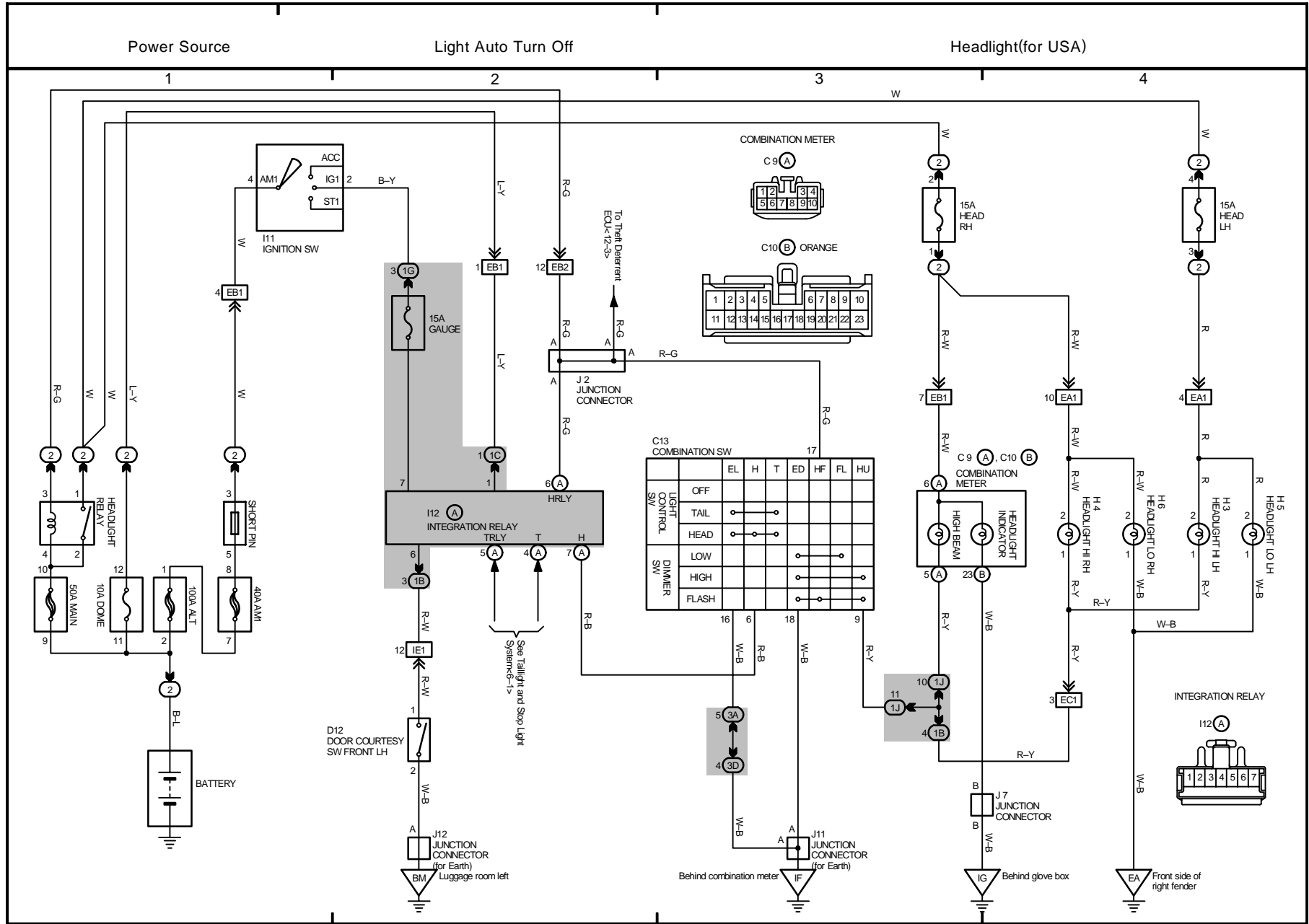





# 6 LEXUS GS300

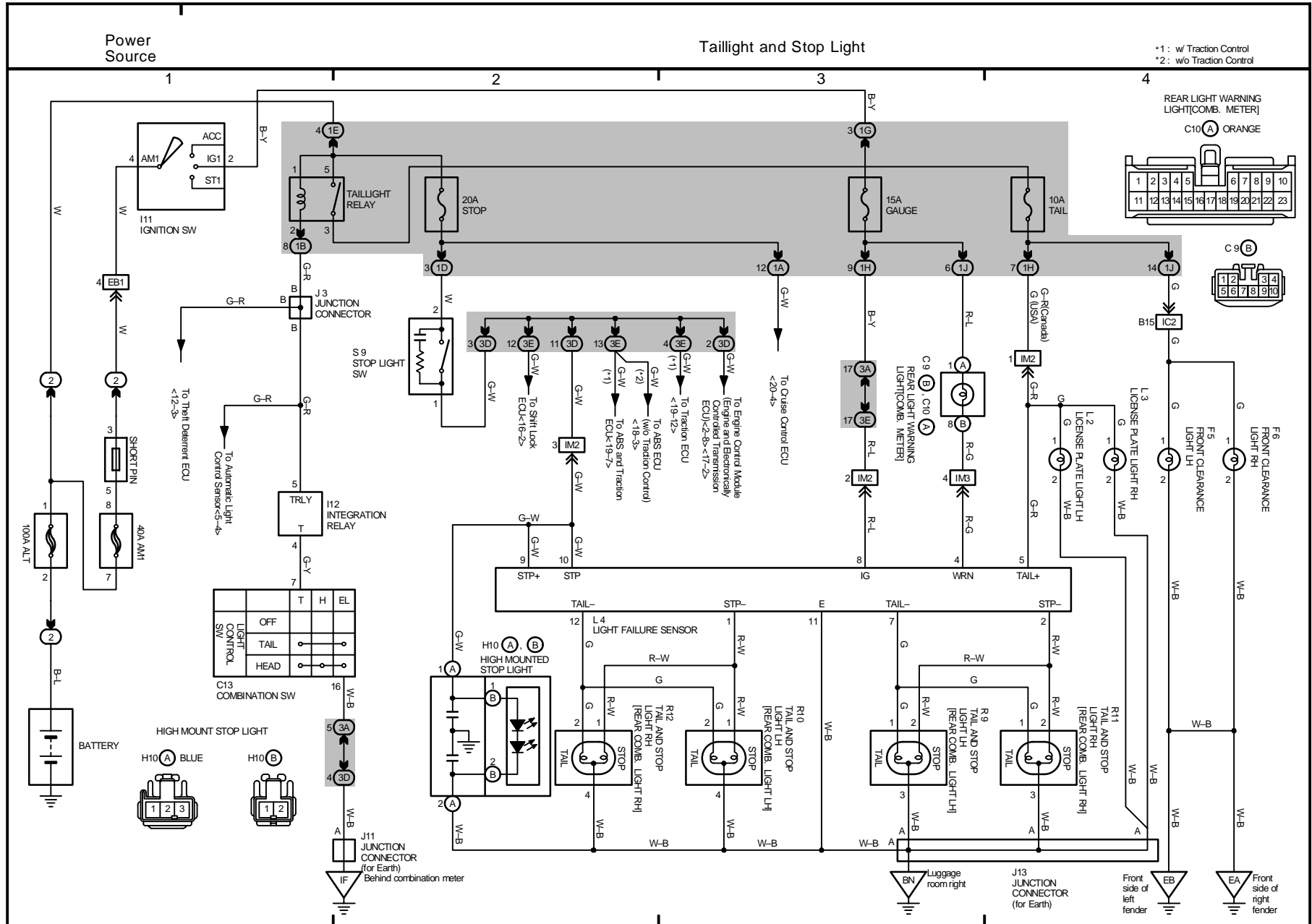





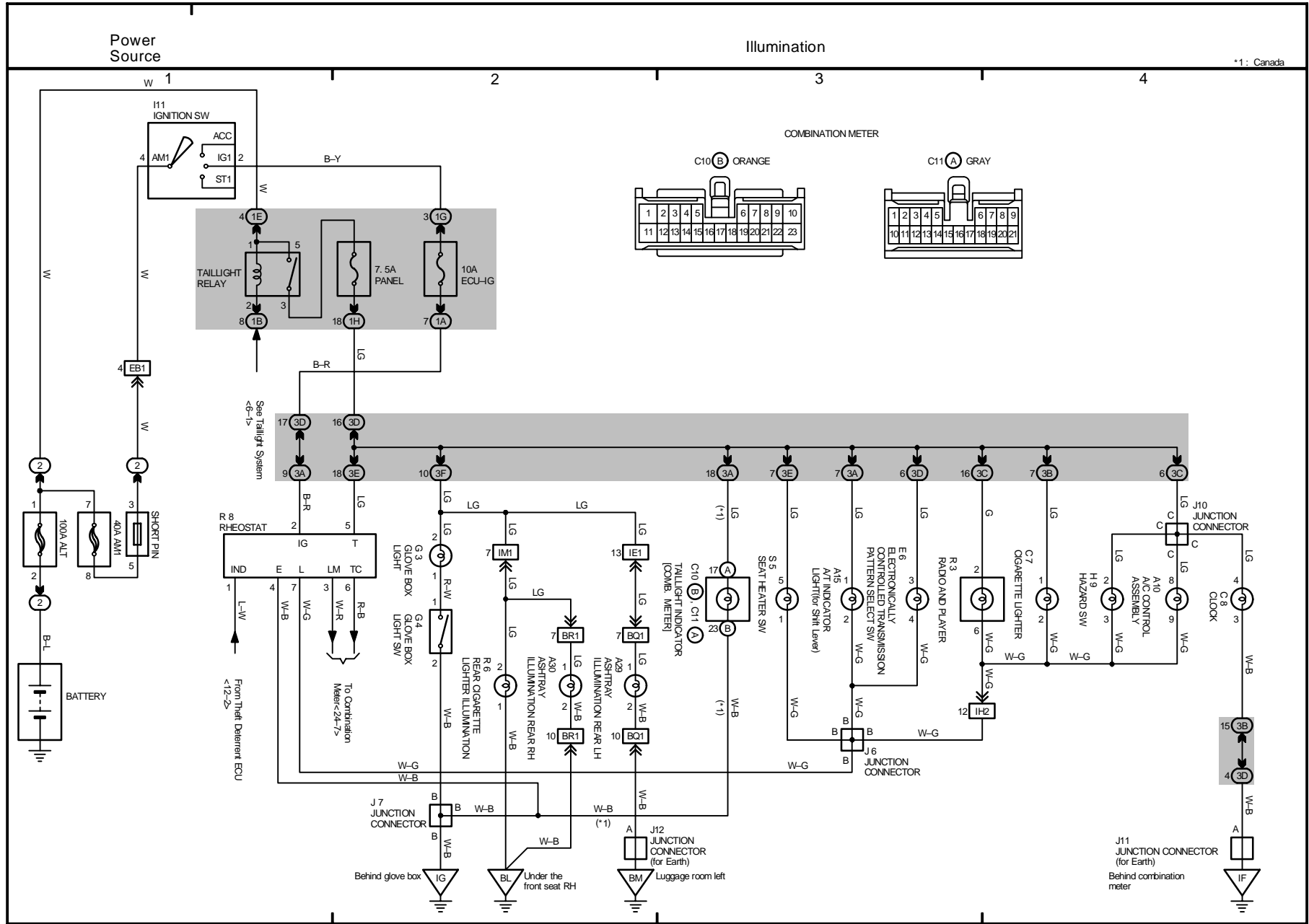

# 9 LEXUS GS300

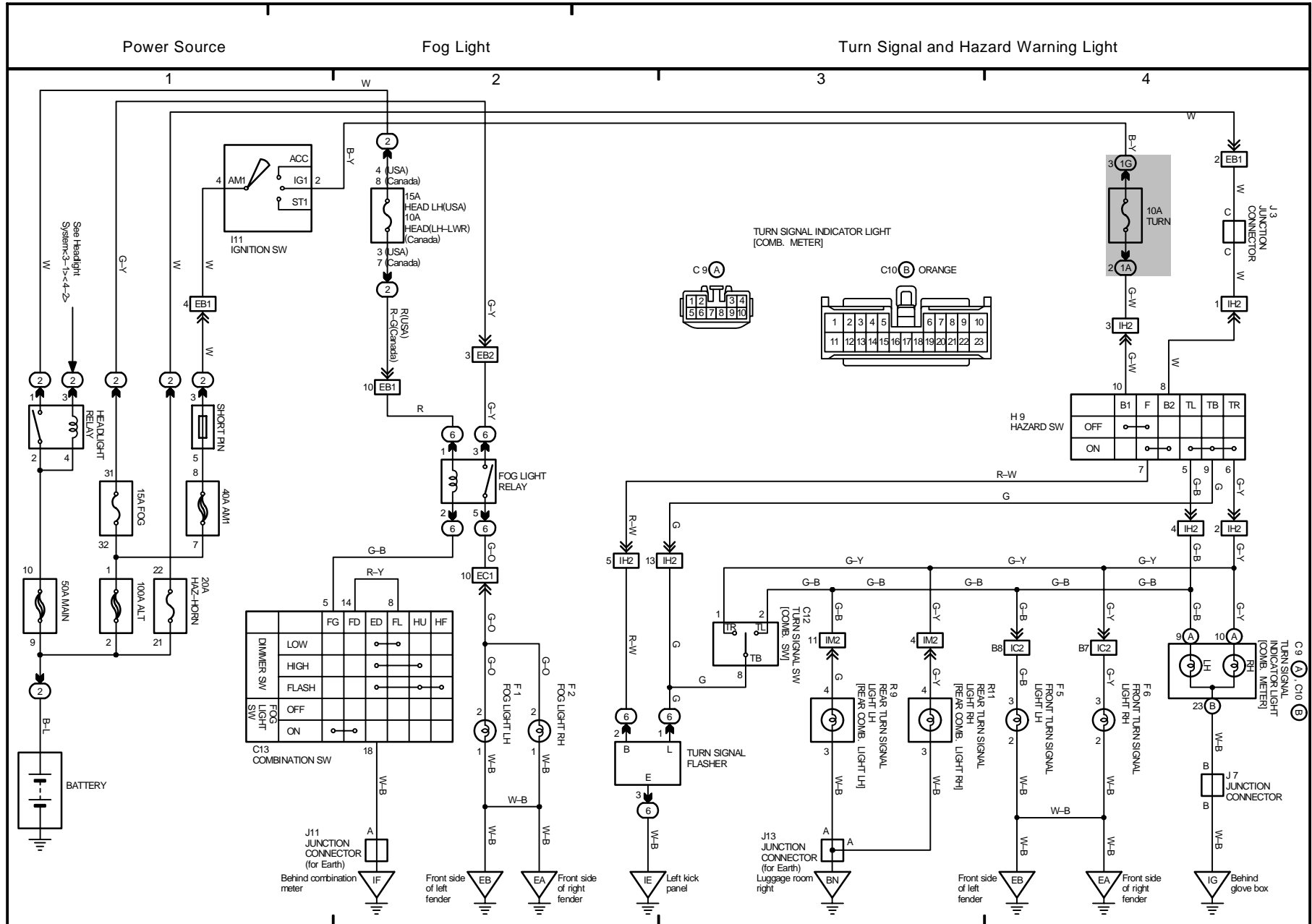



10 LEXUS GS300

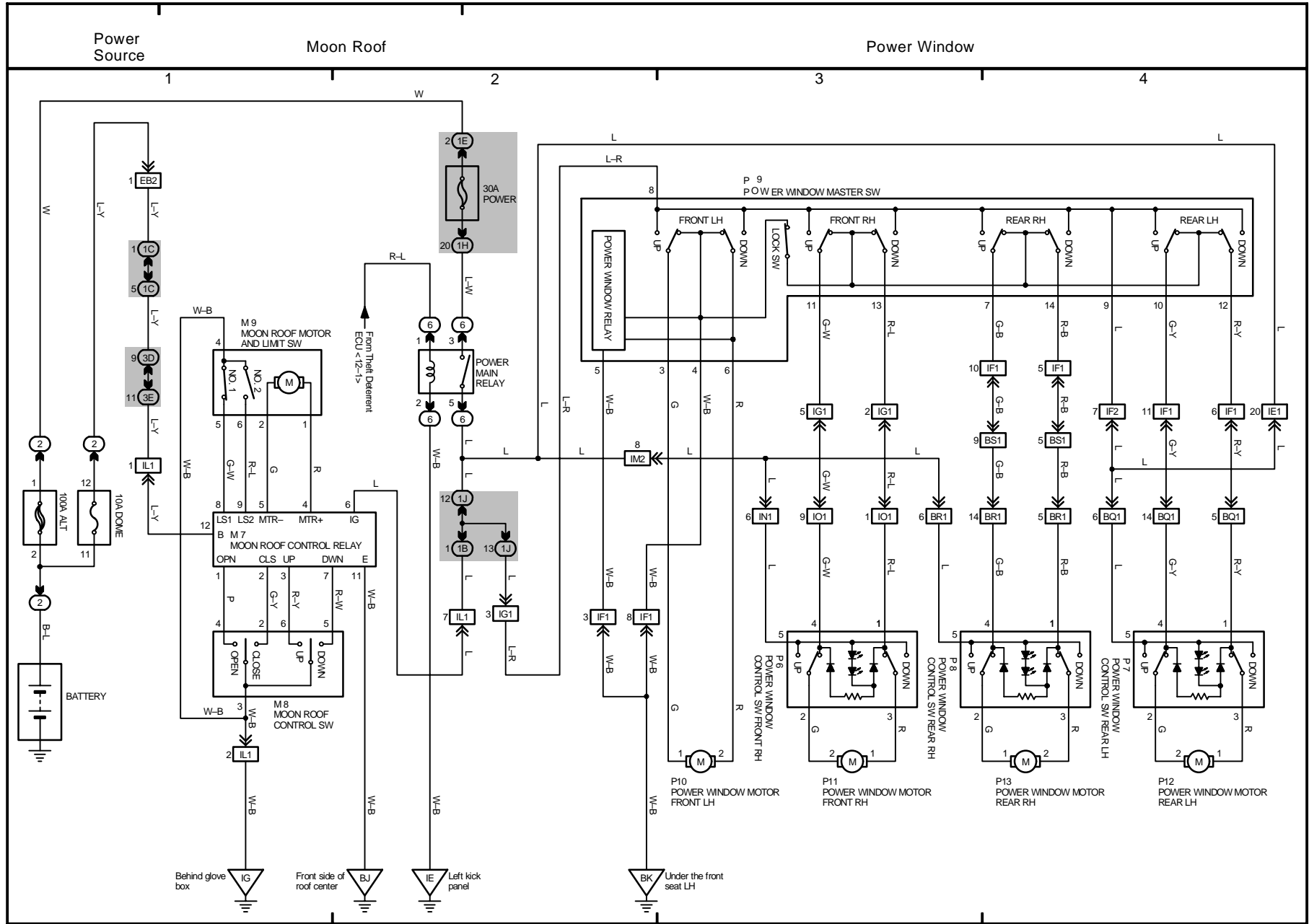

# 11 LEXUS GS300

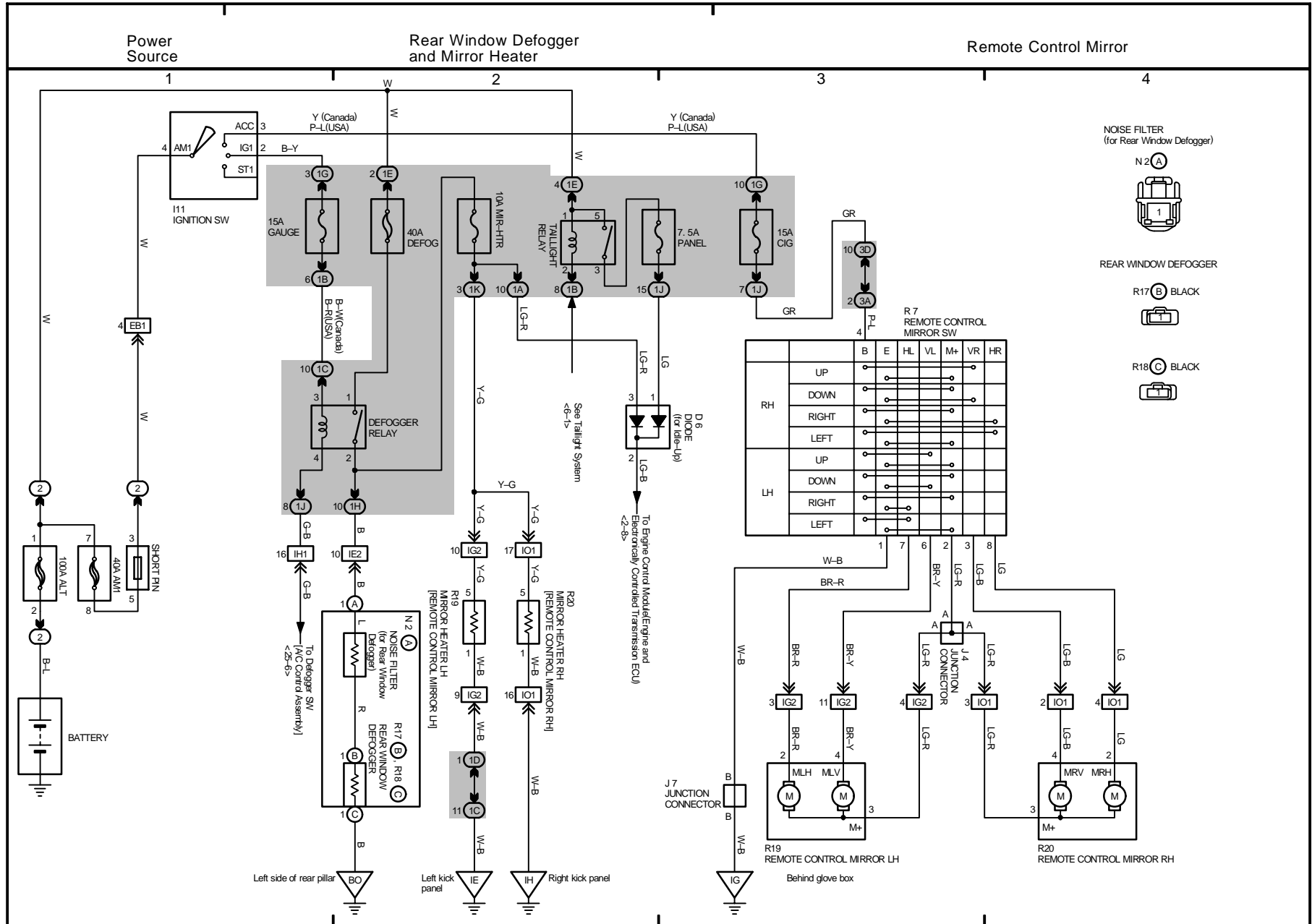



















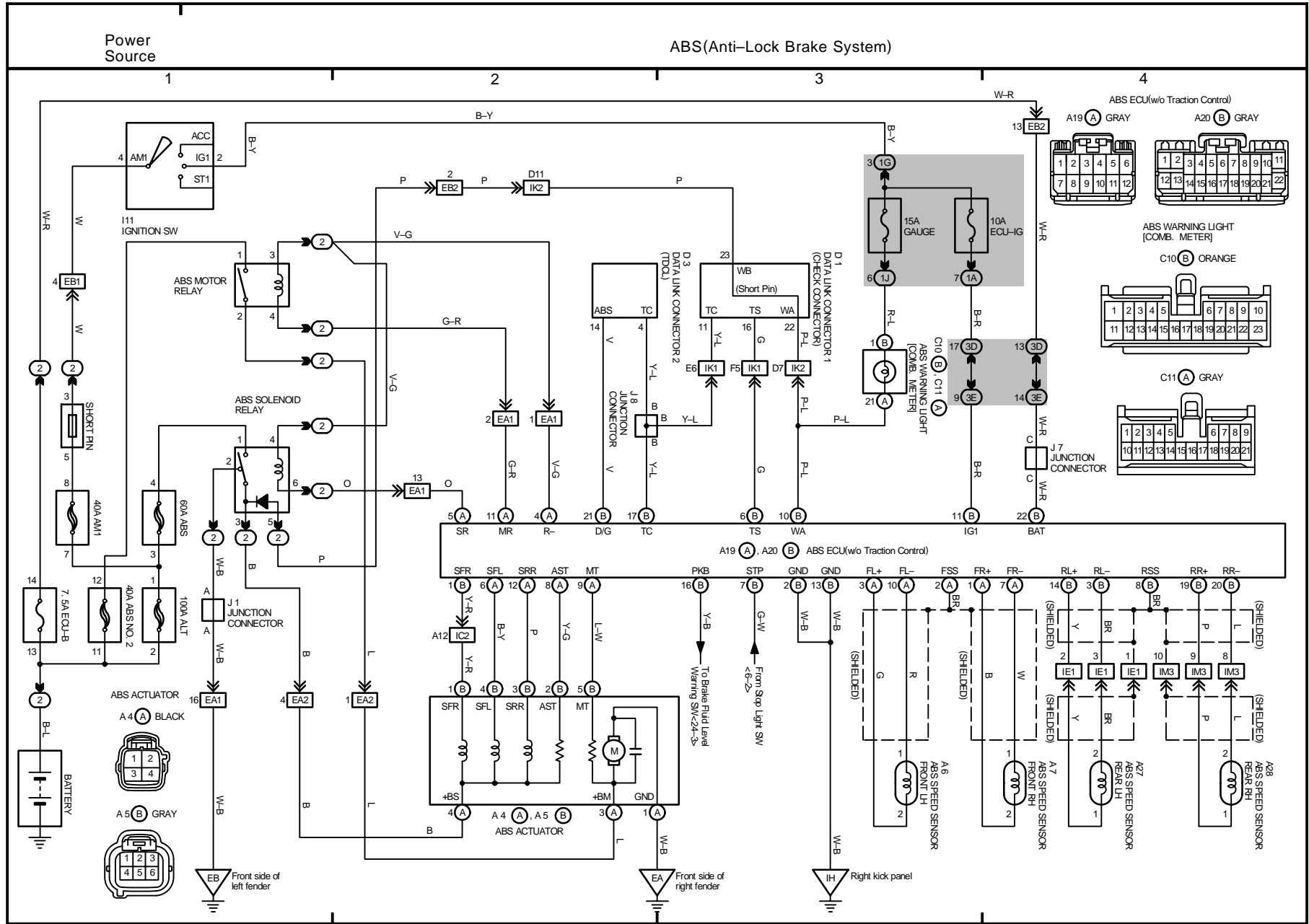



ABS and Traction Control

\*1: Canada  
\*2: USA

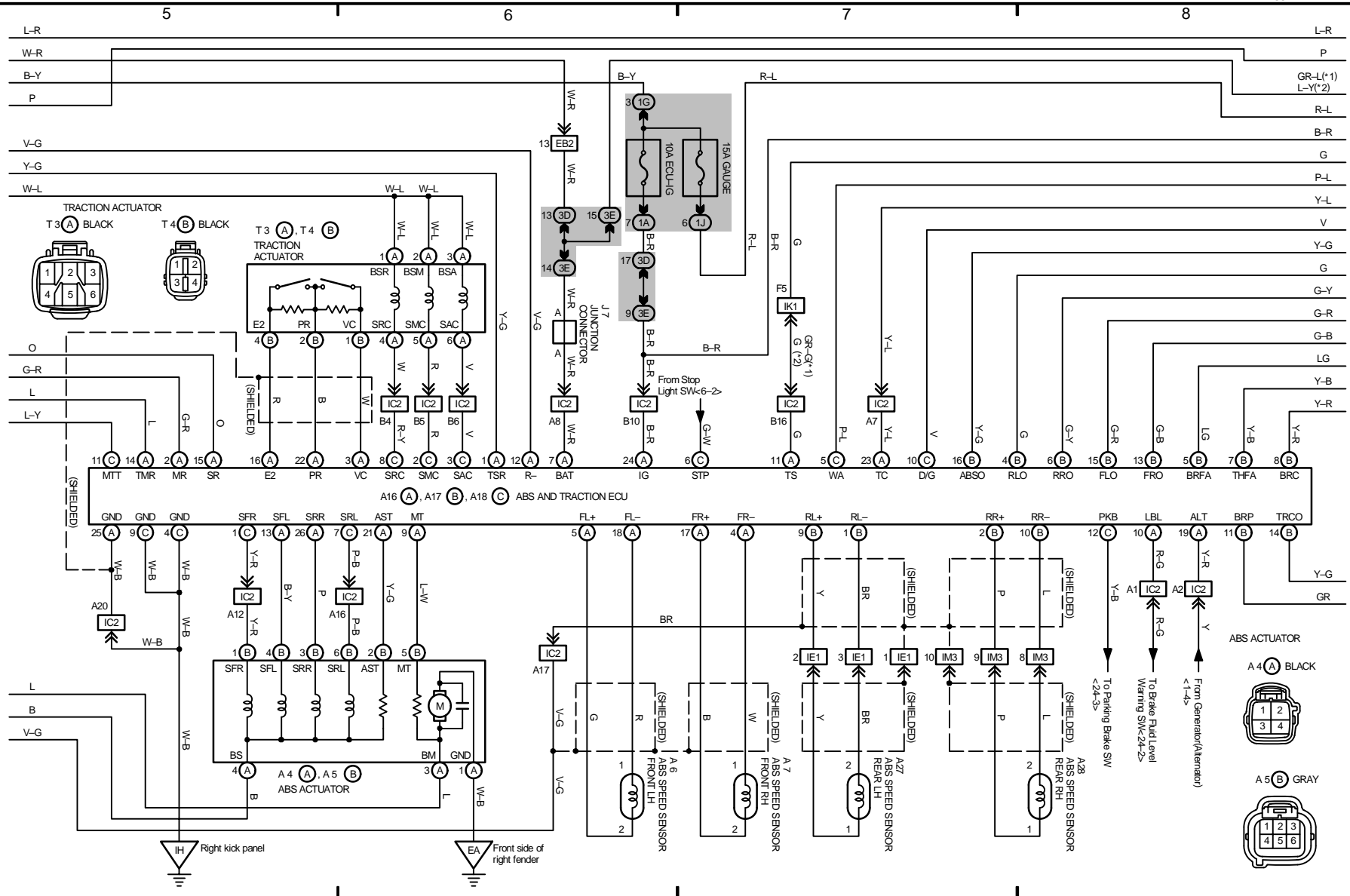

# 19 LEXUS GS300(Cont' d)

## ABS and Traction Control

\*1: Canada  
\*2: USA

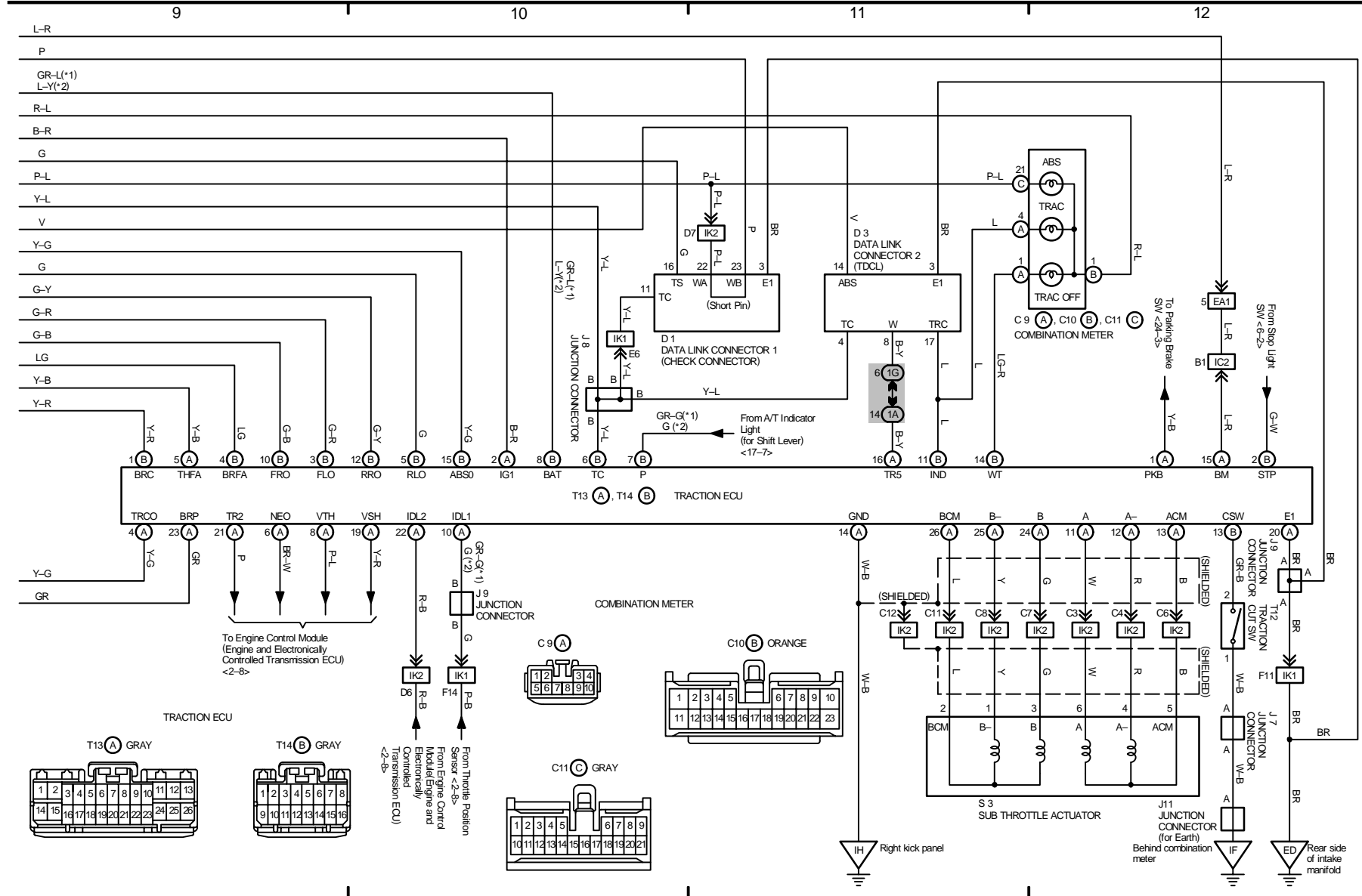







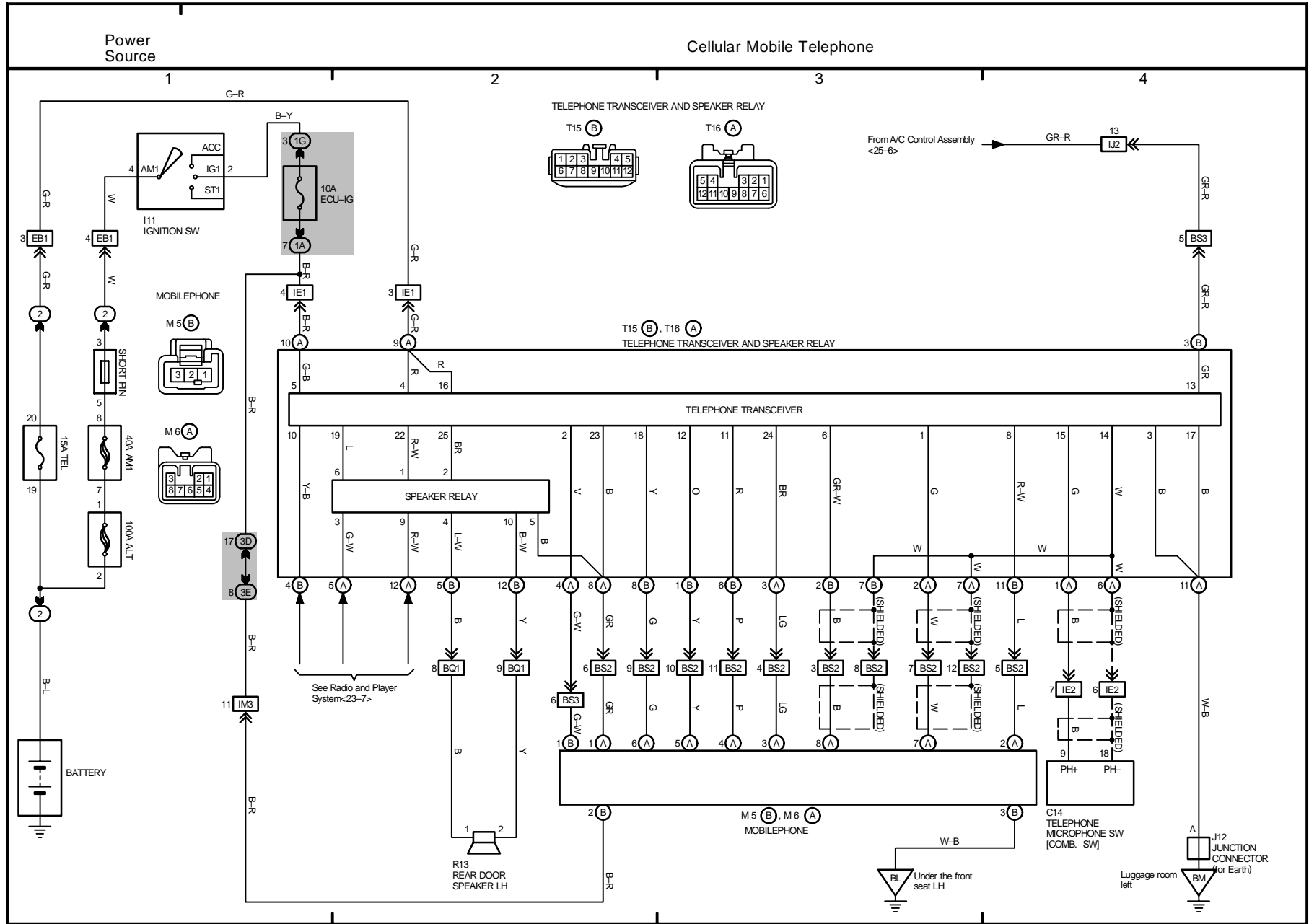

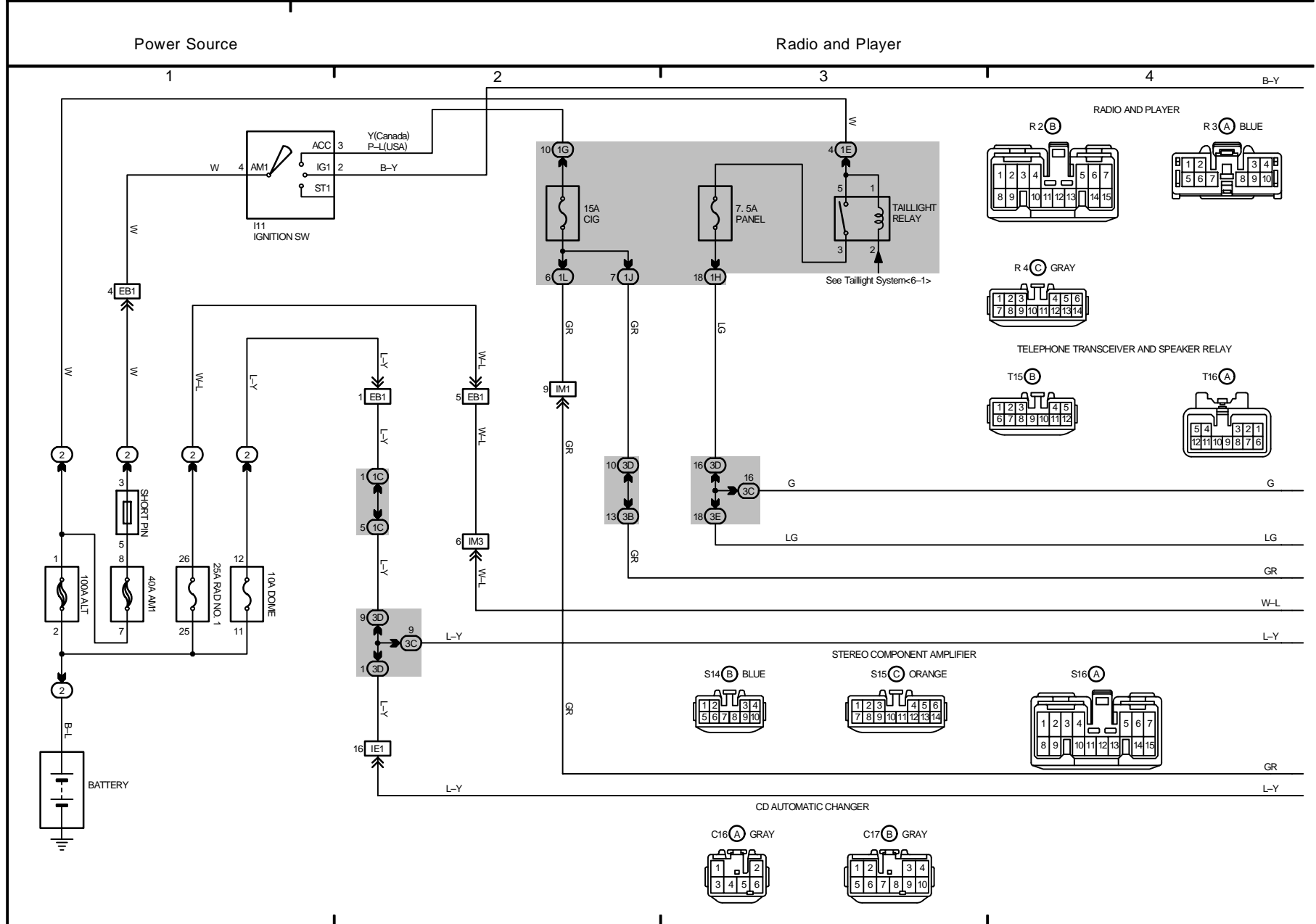

Radio and Player

Auto Antenna

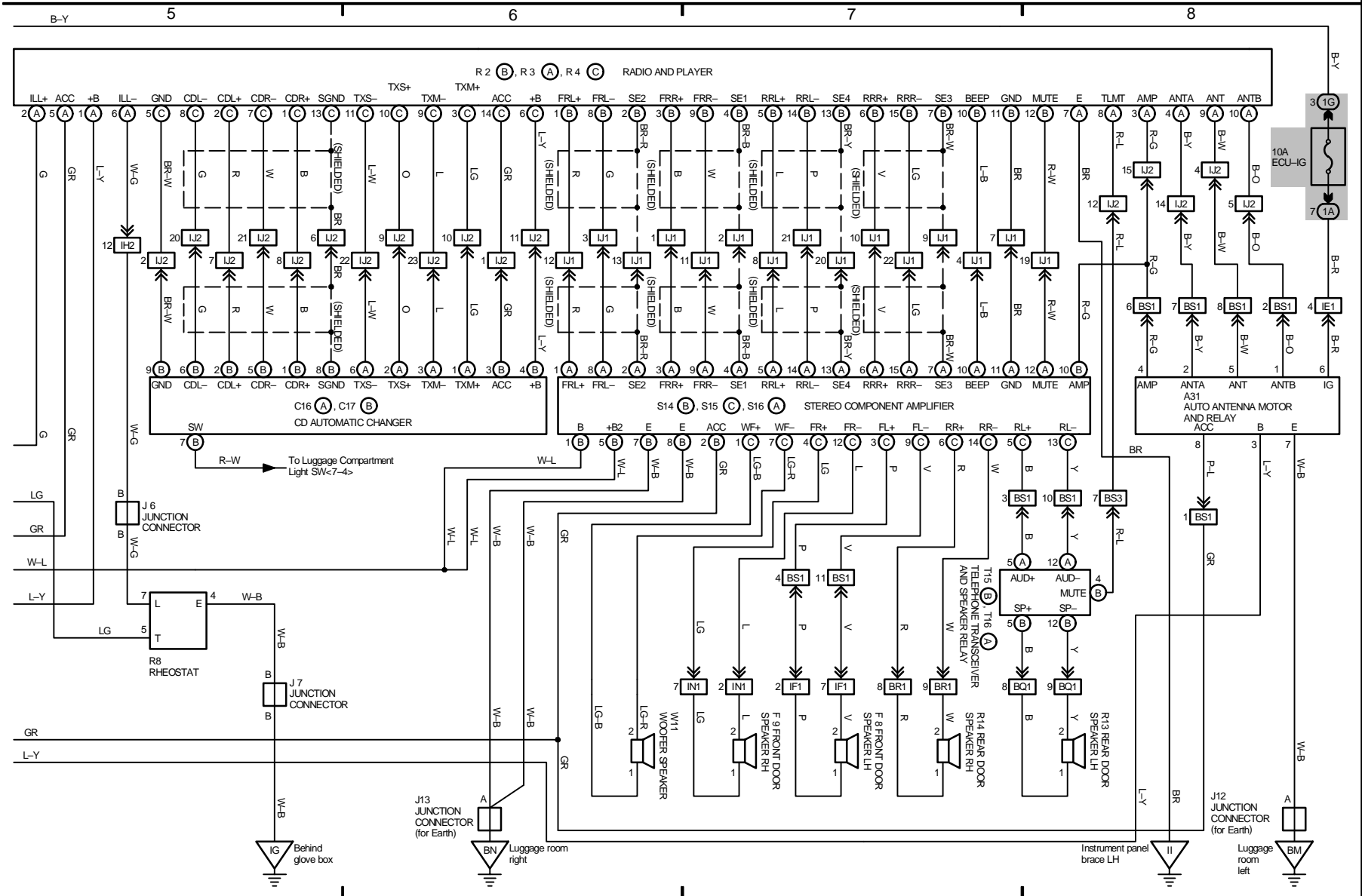



Combination Meter

\*1: USA  
 \*2: Canada  
 \*3: TAILLIGHT INDICATOR(Canada)  
 HEADLIGHT INDICATOR(USA)

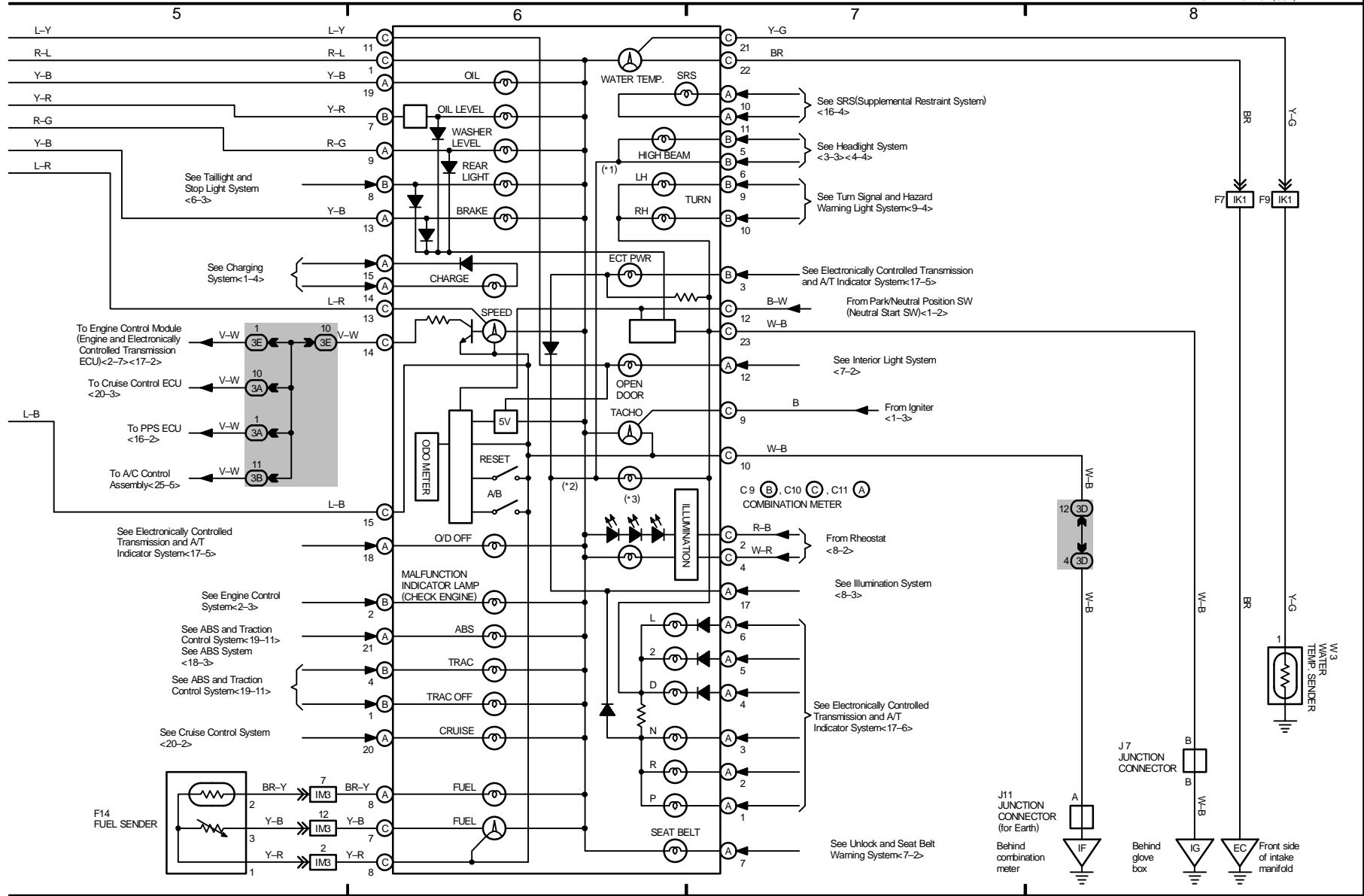

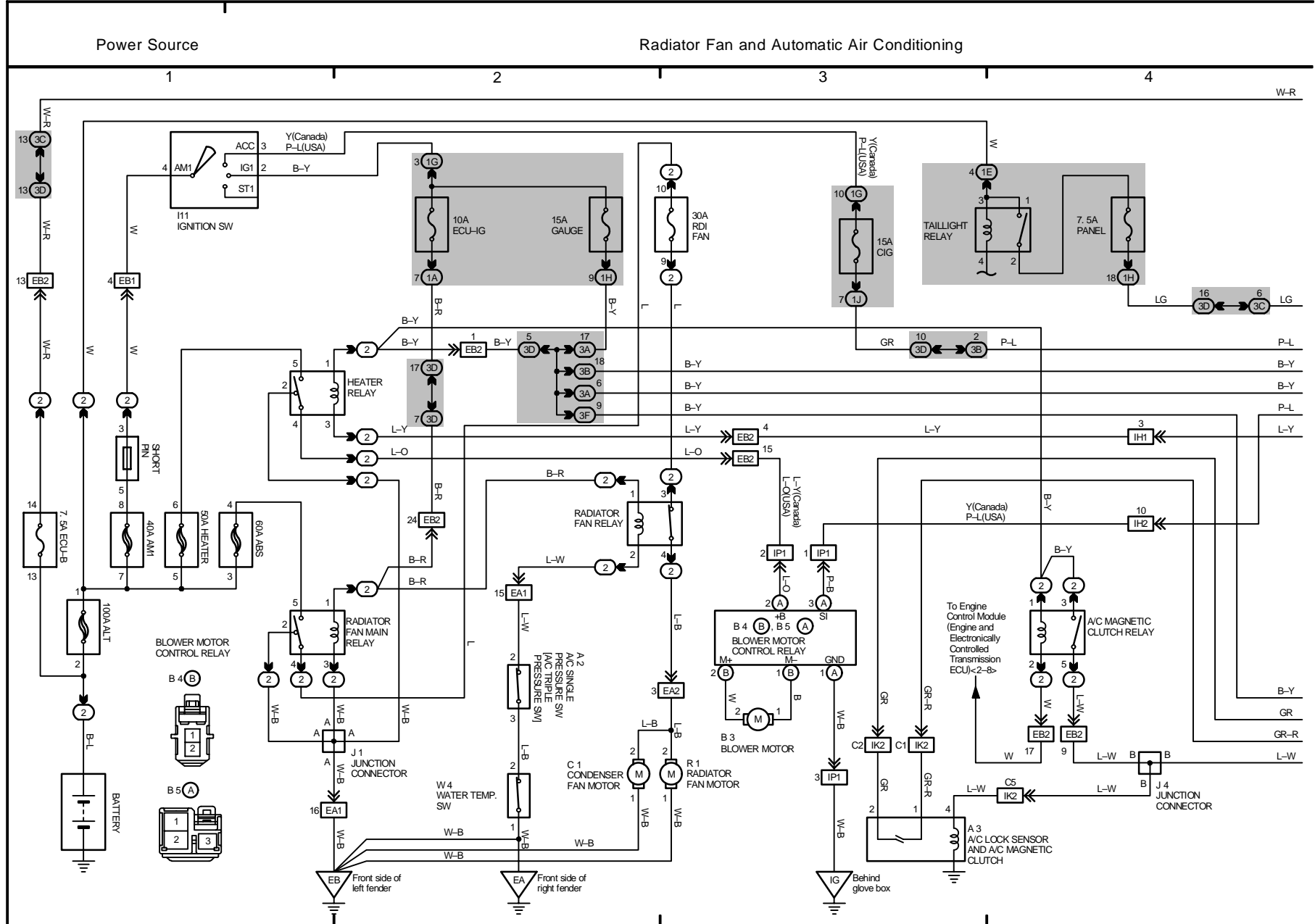

Radiator Fan and Automatic Air Conditioning

