

# Contents

## A-Z

Owner's Manual for  
Vehicle



The Ultimate Driving  
Machine



# THE BMW X5.

## OWNER'S MANUAL.

**BMW EfficientDynamics**  
Less emissions. More driving pleasure.



## **X5** **Owner's Manual for Vehicle**

Thank you for choosing a BMW.

The more familiar you are with your vehicle, the better control you will have on the road. We therefore strongly suggest:

Read this Owner's Manual before starting off in your new BMW. Also use the Integrated Owner's Manual in your vehicle. It contains important information on vehicle operation that will help you make full use of the technical features available in your BMW. The manual also contains information designed to enhance operating reliability and road safety, and to contribute to maintaining the value of your BMW.

Any updates made after the editorial deadline for the printed or Integrated Owner's Manual are located in the appendix of the printed quick reference for the vehicle.

Supplementary information can be found in the additional brochures in the onboard literature.

We wish you a safe and enjoyable drive.

BMW AG

© 2013 Bayerische Motoren Werke  
Aktiengesellschaft  
Munich, Germany  
Reprinting, including excerpts, only with the written  
consent of BMW AG, Munich.  
US English X/13, 11 13 490  
Printed on environmentally friendly paper, bleached  
without chlorine, suitable for recycling.

# Contents

The fastest way to find information on a particular topic or item is by using the index, refer to page [254](#).

[6](#) Notes

## At a glance

[14](#) Cockpit

[18](#) iDrive

[26](#) Voice activation system

[29](#) Integrated Owner's Manual in the vehicle

## Controls

[34](#) Opening and closing

[50](#) Adjusting

[63](#) Transporting children safely

[67](#) Driving

[82](#) Displays

[99](#) Lamps

[104](#) Safety

[131](#) Driving stability control systems

[138](#) Driving comfort

[165](#) Climate control

[175](#) Interior equipment

[182](#) Storage compartments

## Driving tips

[190](#) Things to remember when driving

[194](#) Loading

[197](#) Saving fuel

## Mobility

[204](#) Refueling

[206](#) Fuel

[211](#) Wheels and tires

[222](#) Engine compartment

[224](#) Engine oil

[227](#) Coolant

[229](#) Maintenance

[231](#) Replacing components

[239](#) Breakdown assistance

[244](#) Care

## Reference

[250](#) Technical data

[254](#) Everything from A to Z

# Notes

## Using this Owner's Manual

### Orientation

The fastest way to find information on a particular topic is by using the index.

An initial overview of the vehicle is provided in the first chapter.

### Updates made after the editorial deadline

Any updates made after the editorial deadline for the Owner's Manuals are located in the appendix of the printed quick reference for the vehicle.

### User's manual for Navigation, Entertainment, Communication

The topics of Navigation, Entertainment, Communication and the short commands of the voice activation system are described in a separate user's manual, which is also included with the onboard literature.

### Additional sources of information

The service center will be happy to answer any other questions you may have.

Information on BMW, e.g., on technology, is available on the Internet: [bmwusa.com](http://bmwusa.com).

## Symbols in the Owner's Manual

 Indicates precautions that must be followed precisely in order to avoid the possibility of personal injury and serious damage to the vehicle.

◄ Marks the end of a specific item of information.

"..." Identifies Control Display texts used to select individual functions.

»...◄ Verbal instructions to use with the voice activation system.

»...◄ Identifies the answers generated by the voice activation system.

 Refers to measures that can be taken to help protect the environment.

### Symbols on vehicle components

 Indicates that you should consult the relevant section of this Owner's Manual for information on a particular part or assembly.

## Vehicle equipment

This Owner's Manual describes all models and all standard, country-specific and optional equipment that is offered in the model series. Therefore, in this Owner's Manual, equipment is also described and illustrated that is not available in your vehicle, e.g., because of the selected optional equipment or the country-specific variants.

This also applies for safety-related functions and systems.

For any options and equipment not described in this Owner's Handbook, refer to the Supplementary Owner's Handbooks.

On right-hand drive vehicles, some controls are arranged differently than shown in the illustrations.

## Status of the Owner's Manual

### Basic information

The manufacturer of your vehicle pursues a policy of constant development that is conceived to ensure that our vehicles continue to embody the highest quality and safety stan-

dards. In rare cases, therefore, the features described in this Owner's Manual may differ from those in your vehicle.

### Updates made after the editorial deadline

Any updates made after the editorial deadline for the Owner's Manuals are located in the appendix of the printed quick reference for the vehicle.

## For your own safety

### Warranty

Your vehicle is technically configured for the operating conditions and registration requirements applying in the country of first delivery - homologation. If your vehicle is to be operated in a different country it might be necessary to adapt your vehicle to potentially differing operating conditions and permit requirements. If your vehicle does not comply with the homologation requirements in a certain country you cannot lodge warranty claims for your vehicle there. Further information can be obtained from your Service Centre.

### Maintenance and repairs

Advanced technology, e.g., the use of modern materials and high-performance electronics, requires suitable maintenance and repair methods.

Therefore, have this work performed only by a BMW center or a workshop that works according to BMW repair procedures with appropriately trained personnel.

If this work is not carried out properly, there is the danger of subsequent damage and related safety hazards.

## Parts and Accessories

BMW recommends using parts and accessories approved by BMW for this purpose.

Your BMW center is the right contact for genuine BMW parts and accessories, other products approved by BMW and related qualified advice.

BMW has tested these products for safety and suitability in relation to BMW vehicles.

BMW can assume responsibility for them. However, we cannot assume any responsibility whatsoever for parts and accessories that have not been specifically approved by BMW.

BMW cannot evaluate whether each individual product from another manufacturer can be used with BMW vehicles without presenting a safety hazard. This guarantee is also not applicable when country-specific government approval has been granted. Testing of this kind may fail to embrace the entire range of potential operating conditions to which components might be exposed on BMW vehicles. Such products could conceivably fail to comply with BMW's own stringent quality standards.

### California Proposition 65 Warning

California laws require us to state the following warning:

Engine exhaust and a wide variety of automobile components and parts, including components found in the interior furnishings in a vehicle, contain or emit chemicals known to the State of California to cause cancer and birth defects and reproductive harm. In addition, certain fluids contained in vehicles and certain products of component wear contain or emit

chemicals known to the State of California to cause cancer and birth defects or other reproductive harm. Battery posts, terminals and related accessories contain lead and lead compounds. Wash your hands after handling. Used engine oil contains chemicals that have caused cancer in laboratory animals. Always protect your skin by washing thoroughly with soap and water.

## Service and warranty

We recommend that you read this publication thoroughly. Your vehicle is covered by the following warranties:

- ▷ New Vehicle Limited Warranty.
- ▷ Rust Perforation Limited Warranty.
- ▷ Federal Emissions System Defect Warranty.
- ▷ Federal Emissions Performance Warranty.
- ▷ California Emission Control System Limited Warranty.

Detailed information about these warranties is listed in the Service and Warranty Information Booklet for US models or in the Warranty and Service Guide Booklet for Canadian models.

Your vehicle has been specifically adapted and designed to meet the particular operating conditions and homologation requirements in your country and continental region in order to deliver the full driving pleasure while the vehicle is operated under those conditions. If you wish to operate your vehicle in another country or region, you may be required to adapt your vehicle to meet different prevailing operating conditions and homologation requirements. You should also be aware of any applicable warranty limitations or exclusions for such country or region. In such case, please contact Customer Relations for further information.

## Maintenance

Maintain the vehicle regularly to sustain the road safety, operational reliability and the New Vehicle Limited Warranty.

Specifications for required maintenance measures:

- ▷ BMW Maintenance system
- ▷ Service and Warranty Information Booklet for US models
- ▷ Warranty and Service Guide Booklet for Canadian models

If the vehicle is not maintained according to these specifications, this could result in serious damage to the vehicle. Such damage is not covered by the BMW New Vehicle Limited Warranty.

## Data memory

Many electronic components on your vehicle are equipped with data memories that temporarily or permanently store technical information about the condition of the vehicle, events and faults. This technical information generally documents the state of a component, a module, a system or the environment:

- ▷ Operating states of system components, fill levels for instance.
- ▷ Status messages for the vehicle and from its individual components, e.g., wheel rotation speed/ vehicle speed, deceleration, transverse acceleration.
- ▷ Malfunctions and faults in important system components, e.g., lights and brakes.
- ▷ Responses by the vehicle to special situations, e.g., deployment of an airbag, engagement of stability control systems.
- ▷ Ambient conditions, such as temperature.

This data is purely technical in nature and is used to detect and correct faults and to optimize vehicle functions. Motion profiles over routes traveled cannot be created from this data. When service offerings are used, e.g., repair services, service processes, warranty claims, quality assurance, this technical information can be read out from the event and fault memories by the service personnel, in-



cluding the manufacturer, using special diagnostic tools. You can obtain further information there if it is needed. After a fault is corrected, the information in the fault memory is deleted or overwritten on a continuous basis.

When the vehicle is in use, situations are conceivable in which it might be possible to associate this technical data with individuals if it is combined with other information, e.g., an accident report, damage to the vehicle, eye witness accounts — possibly with the assistance of an expert.

Additional functions that are contractually agreed with the customer, such as vehicle locating in an emergency, enable certain vehicle data to be transmitted from the vehicle.

## Event Data Recorder EDR

This vehicle is equipped with an event data recorder EDR. The main purpose of an EDR is to record, in certain crash or near crash-like situations, such as an air bag deployment or hitting a road obstacle, data that will assist in understanding how a vehicle's systems performed. The EDR is designed to record data related to vehicle dynamics and safety systems for a short period of time, typically 30 seconds or less.

The EDR in this vehicle is designed to record such data as:

- ▶ How various systems in your vehicle were operating.
- ▶ Whether or not the driver and passenger safety belts were fastened.
- ▶ How far, if at all, the driver was depressing the accelerator and/or brake pedal.
- ▶ How fast the vehicle was traveling.

These data can help provide a better understanding of the circumstances in which crashes and injuries occur.

EDR data are recorded by your vehicle only if a nontrivial crash situation occurs; no data are

recorded by the EDR under normal driving conditions and no personal data, e.g., name, gender, age, and crash location, are recorded.

However, other parties, such as law enforcement, could combine the EDR data with the type of personally identifying data routinely acquired during a crash investigation.

To read data recorded by an EDR, special equipment is required, and access to the vehicle or the EDR is needed. In addition to the vehicle manufacturer, other parties, such as law enforcement, that have the special equipment, can read the information if they have access to the vehicle or the EDR.

## Reporting safety defects

### For US customers

The following only applies to vehicles owned and operated in the US.

If you believe that your vehicle has a defect which could cause a crash or could cause injury or death, you should immediately inform the National Highway Traffic Safety Administration NHTSA, in addition to notifying BMW of North America, LLC, P.O. Box 1227, Westwood, New Jersey 07675-1227, Telephone 1-800-831-1117.

If NHTSA receives similar complaints, it may open an investigation, and if it finds that a safety defect exists in a group of vehicles, it may order a recall and remedy campaign.

However, NHTSA cannot become involved in individual problems between you, your dealer, or BMW of North America, LLC.

To contact NHTSA, you may call the Vehicle Safety Hotline toll-free at 1-888-327-4236 (TTY: 1-800-424-9153); go to <http://www.safercar.gov>; or write to: Administrator, NHTSA, 400 Seventh Street, SW., Washington, DC 20590. You can also obtain other information about motor vehicle safety from <http://www.safercar.gov>.

## For Canadian customers

Canadian customers who wish to report a safety-related defect to Transport Canada, Defect Investigations and Recalls, may telephone the toll-free hotline 1-800-333-0510. You can also obtain other information about motor vehicle safety from <http://www.tc.gc.ca/roadsafety>.





## At a glance

These overviews of buttons, switches and displays are intended to familiarize you with your vehicle. You will also become quickly acquainted with the available control concepts and options.

# Cockpit

## Vehicle equipment

All standard, country-specific and optional equipment that is offered in the model series is described in this chapter. Therefore, equip-

ment is also described that is not available in a vehicle, e. g., because of the selected optional equipment or country variant. This also applies for safety-related functions and systems.

## All around the steering wheel

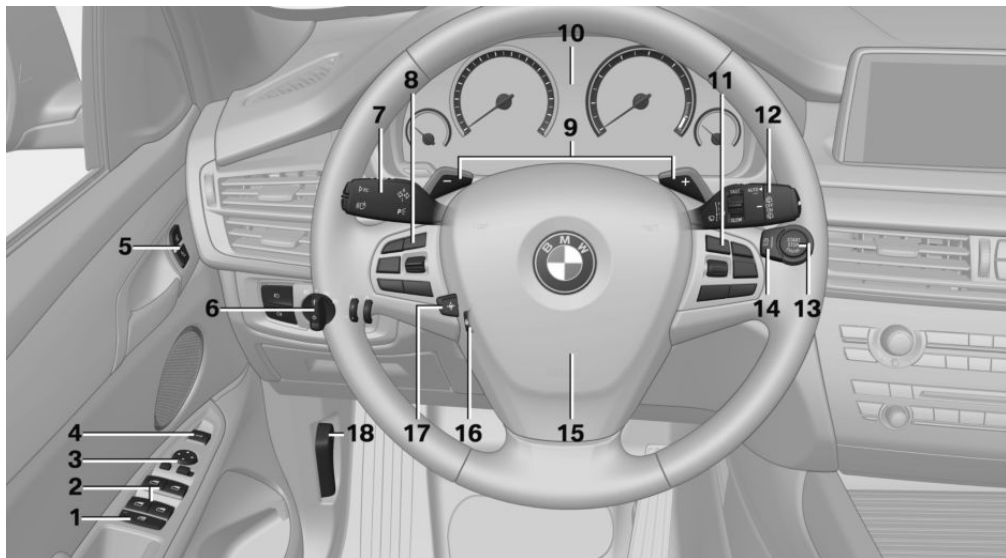

1 Rear window safety switch 47

2 Power windows 46

3 Exterior mirror operation 60

4  Opening and closing top tailgate 40

5  Unlocking central locking system 40

 Locking central locking system 40

6 Lamps



Front fog lamps 102



Parking lamps 99



Low beams 99































Automatic headlamp control 100

Daytime running lights 100

Adaptive Light Control 100









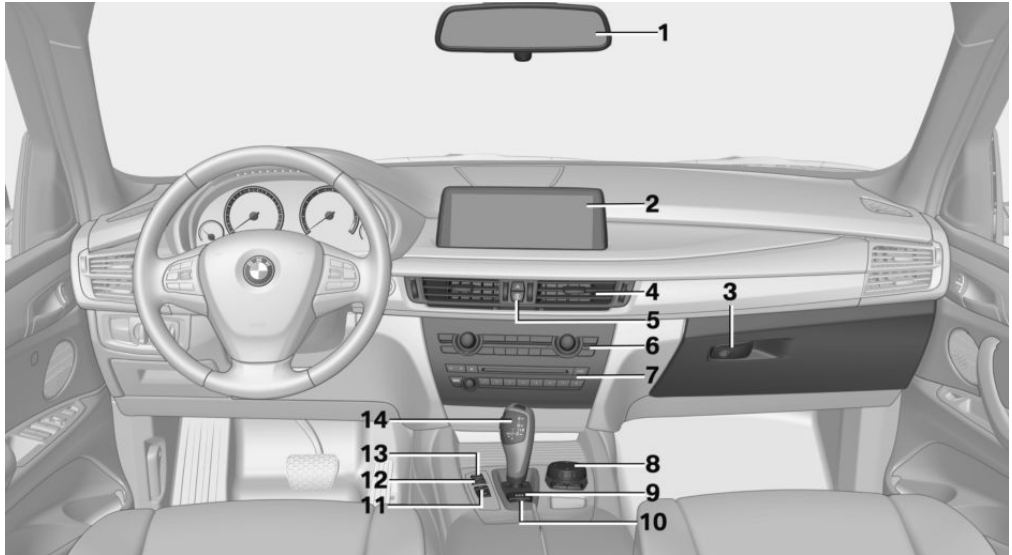



High-beam Assistant 101

-  Instrument lighting [102](#)
-  Night Vision, switch on/switch off heat image [121](#)
- 7** Steering column stalk, left
-  Turn signal [74](#)
-  High beams, head-lamp flasher [74](#)
-  High-beam Assistant [101](#)
-  Roadside parking lamps [100](#)
-  Computer [93](#)
- 8** Steering wheel buttons, left
-  Store speed [148](#), [138](#)
-  Resume speed [150](#), [141](#)
-  Cruise control on/off, interrupting [138](#)
-  Cruise control on/off, interrupting [149](#)
-  Congestion Assistant ON/OFF, Pause [145](#)
-  Congestion Assistant: setting cruise control distance [138](#)
-  Cruise control, reduce distance [138](#)
-  Cruise control, increase distance [138](#)
- Cruise control rocker switch [149](#), [140](#)
- 9** Shift paddles [80](#)
- 10** Instrument cluster [82](#)
- 11** Steering wheel buttons, right
-  Entertainment source
-  Volume
-  Voice activation [26](#)
-  Telephone, see user's manual for Navigation, Entertainment and Communication
- Thumbwheel for selection lists [93](#)
- 12** Steering column stalk, right
-  Windshield wipers [75](#)
-  Rain sensor [75](#)
-  Clean the windshields and headlamps [75](#)
-  Rear window wiper in Canadian models [77](#)
-  Rear window wiper [77](#)
-  Cleaning rear window [77](#)
- 13**  Start/stop the engine and switch the ignition on/off [68](#)
- 14**  Auto Start/Stop function [69](#)
- 15** Horn
- 16**  Steering wheel heating [62](#)
- 17**  Adjust steering wheel [61](#)

18 Unlock hood 222

## All around the center console









- |   |  |     |    |   |                               |     |
|---|--|-----|----|---|-------------------------------|-----|
| 1 | All around the headliner   | 17  | 10 |    | Auto Hold                     | 72  |
| 2 | Control Display  | 18  | 11 |   | PDC Park Distance Control     | 150 |
| 3 | Glove compartment  | 182 |    |  | Rearview camera               | 153 |
| 4 | Ventilation  | 168 |    |  | Top View                      | 156 |
| 5 |  Hazard warning system     | 239 |    |  | Parking assistant             | 159 |
|   |  Intelligent Safety button | 112 |    |  | Panorama View                 | 158 |
| 6 | Automatic climate control  | 165 |    |  | HDC Hill Descent Control      | 133 |
| 7 | Radio/CD/Multimedia, see user's manual for Navigation, Entertainment and Communication                       |     | 12 |  | Driving Dynamics Control      | 135 |
| 8 | Controller with buttons  | 18  | 13 |  | DSC Dynamic Stability Control | 132 |
| 9 |  Parking brake             | 71  |    |   |                               |     |

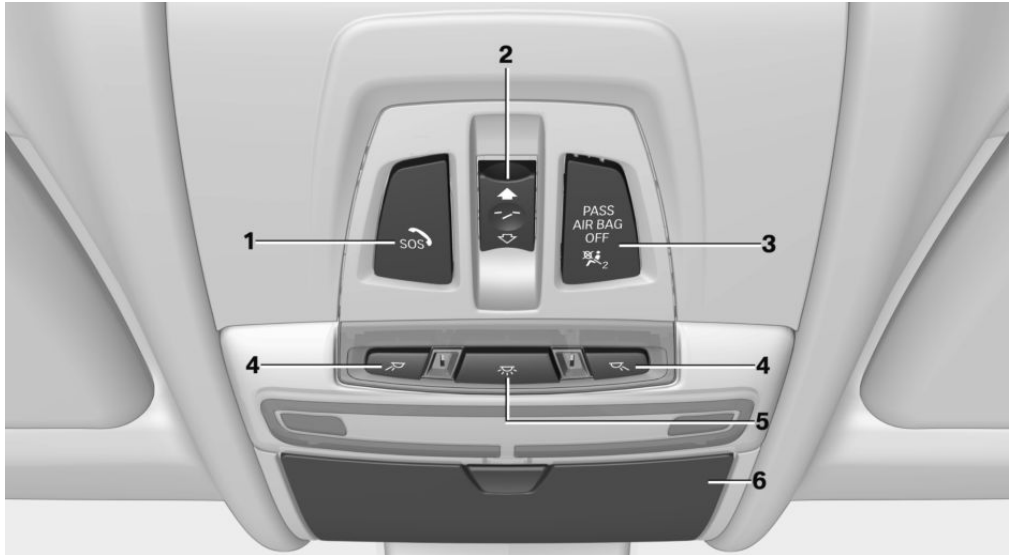

## 14 Transmission selector lever 78

## All around the headliner



- |   |   |  |   |  |                         |
|---|---|--|---|--|-------------------------|
| 1 |    | Intelligent Emergency Request 239          | 4 |   | Reading lamps 103       |
| 2 |   | Panoramic glass sunroof 48                 | 5 |  | Interior lamps 103      |
| 3 |  | Indicator lamp, front passenger airbag 106 | 6 |  | Glasses compartment 184 |

# iDrive

## Vehicle equipment

All standard, country-specific and optional equipment that is offered in the model series is described in this chapter. Therefore, equipment is also described that is not available in a vehicle, e. g., because of the selected optional equipment or country variant. This also applies for safety-related functions and systems.

## The concept

The iDrive combines the functions of a multitude of switches. Thus, these functions can be operated from a central location.

 Using the iDrive during a trip

To avoid becoming distracted and posing an unnecessary hazard to your vehicle's occupants and to other road users, never attempt to use the controls or enter information unless traffic and road conditions allow this. ◀

## Controls at a glance

### Controls

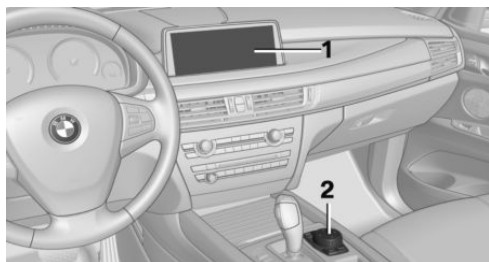

- 1 Control Display
- 2 Controller with buttons and, depending on the equipment version, with touchpad

## Control Display

### Hints

- ▷ To clean the Control Display, follow the care instructions.
- ▷ Do not place objects close to the Control Display; otherwise, the Control Display can be damaged.

### Switching off

1.  Press the button.
2. "Switch off control display"

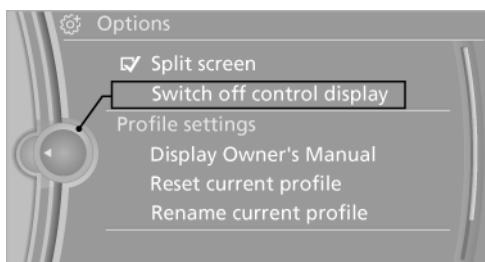

### Switching on

Press the controller again to switch the screen back on.

### Controller with navigation system

The buttons can be used to open the menus directly. The controller can be used to select menu items and create the settings.

Some iDrive functions can be operated using the touchpad on the controller.

## 1. Turn.

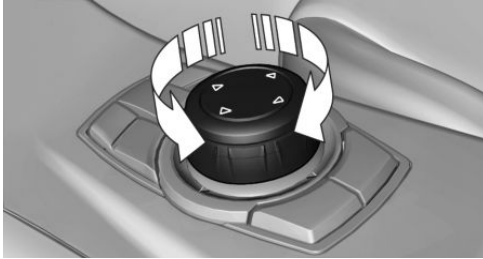

## 2. Press.

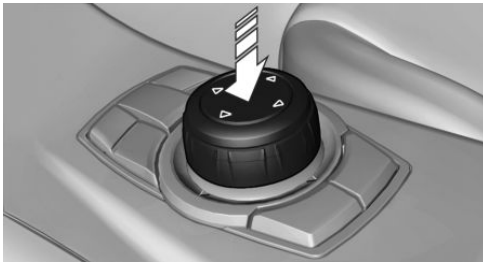

## 3. Move in four directions.

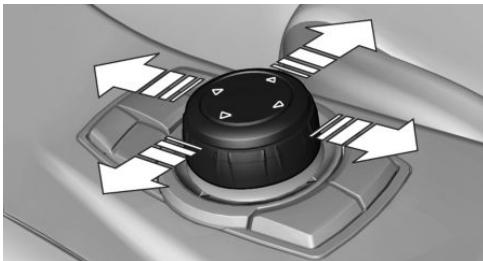

## Buttons on controller

Press the button	Function
MENU	Open the main menu.
RADIO	Opens the Radio menu.
MEDIA	Opens the CD/Multimedia menu.
NAV	Opens the Navigation menu.

Press the button	Function
TEL	Opens the Telephone menu.
BACK	Displays the previous panel.
OPTION	Opens the Options menu.

## Controller without navigation system

The buttons can be used to open the menus directly. The controller can be used to select menu items and create the settings.

## 1. Turn.

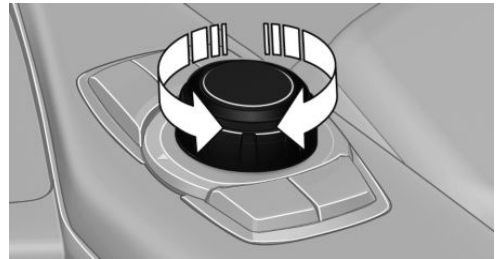

## 2. Press.

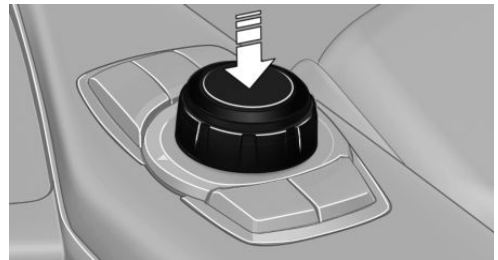

## 3. Move in two directions.

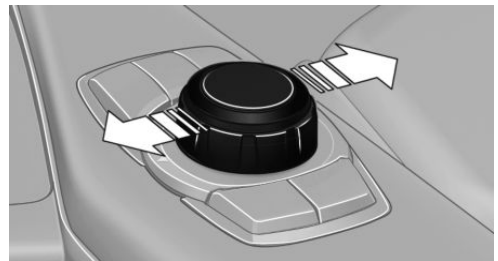

## Buttons on controller

Press the button	Function
MENU	Open the main menu.
Audio	Open audio menu last listened to, switch between audio menus.
TEL	Opens the Telephone menu.
BACK	Open previous panel.
OPTION	Opens the Options menu.

## Operating concept

### Opening the main menu

 Press the button.

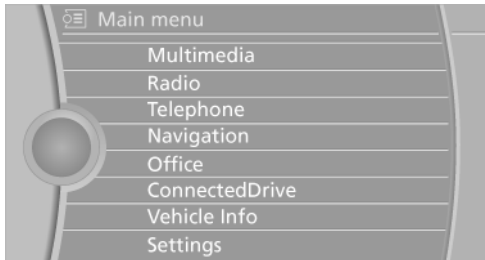

The main menu is displayed.

All iDrive functions can be called up via the main menu.

## Selecting menu items

Highlighted menu items can be selected.

1. Turn the controller until the desired menu item is highlighted.

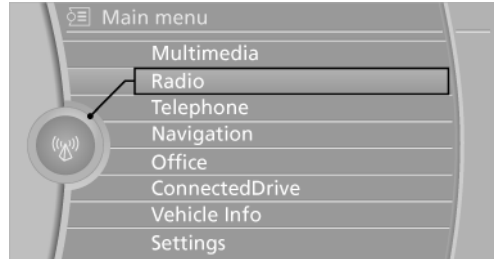

2. Press the controller.

### Menu items in the Owner's Manual

In the Owner's Manual, menu items that can be selected are set in quotation marks, e.g., "Settings".

### Changing between panels

After a menu item is selected, e.g., "Radio", a new panel is displayed. Panels can overlap.

- ▶ Move the controller to the left.

The current panel is closed and the previous panel is displayed.

The previous panel is opened again by pressing the BACK button. In this case, the current panel is not closed.

- ▶ Move the controller to the right.

A new panel is opened on top of the previous display.

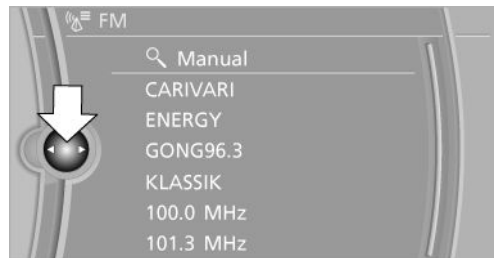

White arrows pointing to the left or right indicate that additional panels can be opened.

## View of an opened menu

When a menu is opened, it generally opens with the panel that was last selected in that menu. To display the first panel of a menu:

- Move the controller to the left repeatedly until the first panel is displayed.
- Press the menu button on the controller twice.

## Opening the Options menu



Press the button.

The "Options" menu is displayed.

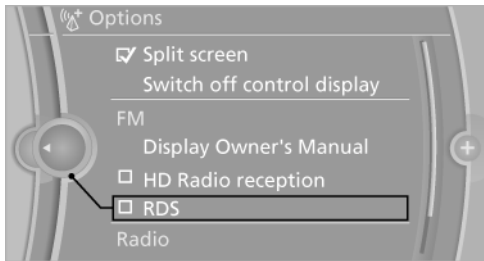

Additional options: move the controller to the right repeatedly until the "Options" menu is displayed.

## Options menu

The "Options" menu consists of various areas:

- Screen settings, e.g., "Split screen".  
This area remains unchanged.
- Control options for the selected main menu, e.g., for "Radio".
- If applicable, further operating options for the selected menu, e.g., "Store station".

## Changing settings

1. Select a field.

2. Turn the controller until the desired setting is displayed.

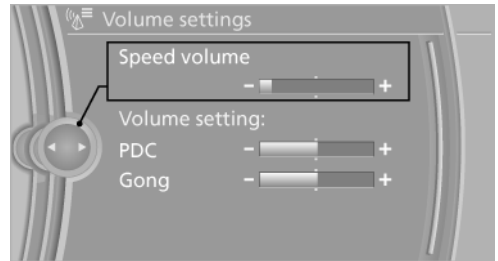

3. Press the controller.

## Activating/deactivating the functions

Several menu items are preceded by a check-box. It indicates whether the function is activated or deactivated. Selecting the menu item activates or deactivates the function.

- The function is activated.
- The function is deactivated.

## Touchpad

Some iDrive functions can be operated using the touchpad on the controller:

### Selecting functions

1. "Settings"
2. "Touchpad"
3. Select the desired function.
  - "Speller": enter letters and numbers.
  - "Interactive map": operating the interactive map.
  - "Browser": enter Internet addresses.
  - "Audio feedback": the entered letters and numbers are announced.

### Entering letters and numbers

The entry of the letters requires some practice at the beginning. In the entry, pay attention to the following:

- ▷ For the input of upper/lower case letters and numbers, it may be necessary to switch via the controller to the corresponding Input mode, refer to page 25, e.g. when the spelling of upper and lower case letters is identical.
- ▷ Enter characters as they are displayed on the Control Display.
- ▷ Always enter accompanying signs, such as accents or periods so that the letter can be clearly recognized. The possibility of input depends on the set language. Where necessary, enter special characters via the controller.
- ▷ To delete a character, slide to the left on the touchpad.
- ▷ To enter a blank space, slide to the right in the center of the touchpad.
- ▷ To enter a hyphen, slide to the right in the upper area of the touchpad.
- ▷ To enter an underscore, slide to the right in the lower area of the touchpad.

## Using interactive map and Internet

The interactive map in the navigation system and Internet sites can be moved via the touchpad.

Function	Controls
Move interactive map or Internet sites.	Slide in the corresponding direction.
Enlarge/shrink interactive map or Internet sites.	Drag inwards or outwards on the touchpad with the fingers.
Display the menu or open a link in the Internet.	Tap once.

## Changing settings

Settings on the control display, such as the volume, can be made via the touchpad. To do this slide to the left or right accordingly.

## Example: setting the clock

### Setting the clock

1.  Press the button. The main menu is displayed.
2. Turn the controller until "Settings" is highlighted, and then press the controller.

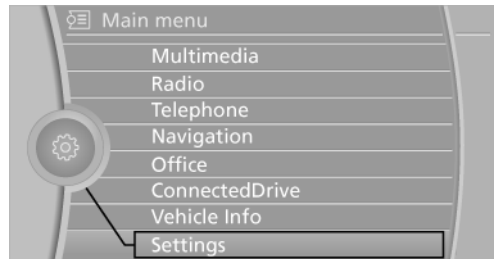

3. If necessary, move the controller to the left to display "Time/Date".
4. Turn the controller until "Time/Date" is highlighted, and then press the controller.



- Turn the controller until "Time:" is highlighted, and then press the controller.

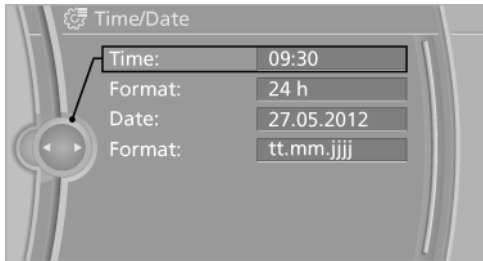

- Turn the controller to set the hours and press the controller.
- Turn the controller to set the minutes and press the controller.

## Status information

### Status field

The following information is displayed in the status field at the top right:

- ▶ Time.
- ▶ Current entertainment source.
- ▶ Sound output, on/off.
- ▶ Wireless network reception strength.
- ▶ Telephone status.
- ▶ Traffic bulletin reception.











### Status field symbols

The symbols are grouped as follows.







#### Radio symbols

Symbol	Meaning
	Satellite radio is switched on.

## Telephone symbols

Symbol	Meaning
	Incoming or outgoing call.
	Missed call.
	Wireless network reception strength Symbol flashes: searching for network.
	Wireless network is not available.
	Bluetooth is switched on.
	Roaming is active.
	Text message was received.
	Check the SIM card.
	SIM card is blocked.
	SIM card is missing.
	Enter the PIN.

## Entertainment symbols

Symbol	Meaning
	CD/DVD player.
	Music collection.
	Gracenote® database.
	AUX-IN port in the front or in the rear.
	USB audio interface.
	Mobile phone audio interface.

## Additional symbols

Symbol	Meaning
	Spoken instructions are switched off.

## Split screen

### General information

Additional information can be displayed on the right side of the split screen, e.g., information from the onboard computer.

In the divided screen view, the so-called split screen, this information remains visible even when you change to another menu.

### Switching the split screen on and off

1.  Press the button.
2. "Split screen"

### Selecting the display

1.  Press the button.
2. "Split screen"
3. Move the controller until the split screen is selected.
4. Press the controller or select "Split screen content".
5. Select the desired menu item.

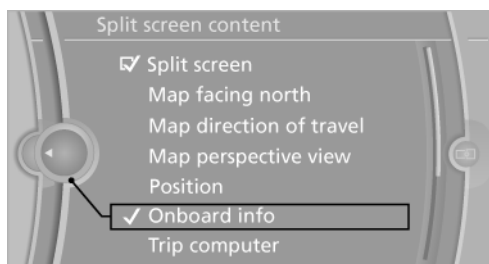

## Programmable memory buttons



### General information

The iDrive functions can be stored on the programmable memory buttons and called up directly, e.g., radio stations, navigation destina-



tions, phone numbers and entry points into the menu.

The settings are stored for the remote control currently in use.

### Saving a function

1. Highlight the function via the iDrive.
2. ... Press the desired button for more than 2 seconds.

### Running a function

1. ... Press the button. The function will run immediately. This means, for example, that the number is dialed when a phone number is selected.

### Displaying the button assignment

Use a finger to touch the buttons. Do not wear gloves or use objects.

The key assignment is displayed at the top edge of the screen.

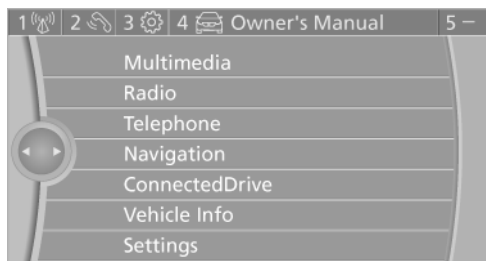

- ▷ To display short information: touch the button.
- ▷ To display detailed information: touch the button for an extended period.

### Deleting the button assignments



1. Press buttons 1 and 8 simultaneously for approx. five seconds.
2. "OK"



## Entering letters and numbers

### General information

1. Turn the controller: select letters or numbers.
2. Select additional letters or numbers if needed.
3. "OK": confirm the entry.

Symbol	Function
	Press the controller: delete the letter or number.
	Press the controller for an extended period: delete all letters or numbers.

### Switching between cases, letters and numbers

Depending on the menu, you can switch between entering upper and lower case, letters and numbers:

Symbol	Function
<b>A<sup>B</sup>C</b>	Enter the letters.
1@+	Enter the numbers.
abc or <b>ABC</b>	Move the controller up.

### Without navigation system

@<sup>A</sup> A<sup>a</sup> a<sup>@</sup> Select the symbol.

### Entry comparison

Entry of names and addresses: the selection is narrowed down every time a letter is entered and letters may be added automatically.

The entries are continuously compared to the data stored in the vehicle.

- ▶ Only those letters are offered during the entry for which data is available.
- ▶ Destination search: town/city names can be entered using the spelling of language available on the Control Display.

# Voice activation system

## Vehicle equipment

All standard, country-specific and optional equipment that is offered in the model series is described in this chapter. Therefore, equipment is also described that is not available in a vehicle, e. g., because of the selected optional equipment or country variant. This also applies for safety-related functions and systems.

## The concept

- ▷ Most functions that are displayed on the Control Display can be operated by spoken commands via the voice activation system. The system prompts you to make your entries.
- ▷ Functions that can only be used when the vehicle is stationary cannot be operated using the voice activation system.
- ▷ The system uses a special microphone on the driver's side.
- ▷ ›...‹ Verbal instructions in the Owner's Manual to use with the voice activation system.

## Requirements

Via the Control Display, set a language that is also supported by the voice activation system so that the spoken commands can be identified.

Set the language, refer to page [96](#).

## Using voice activation

### Activating the voice activation system

1.  Press the button on the steering wheel.
2. Wait for the signal.
3. Say the command.

The command is displayed in the instrument cluster.

 This symbol in the instrument cluster indicates that the voice activation system is active.

If no other commands are available, operate the function in this case via iDrive.

### Terminating the voice activation system

 Briefly press the button on the steering wheel or ›End‹.

## Possible commands

Most menu items on the Control Display can be voiced as commands.

The available commands depend on which menu is currently displayed on the Control Display.

Short commands exist for many functions.

Some list entries, e.g., Phone book entries, can also be selected via the voice activation system. Speak these list entries exactly as they are displayed in the respective list.

### Having possible commands read aloud

You can have the available commands read out loud for you: ›commands‹

For example, if the "Settings" menu is displayed, the commands for the settings are read out loud.

## Executing functions using short commands

Functions on the main menu can be performed directly by means of short commands, nearly irrespective of which menu item is currently selected, e.g., ›Vehicle status‹.

List of short commands of the voice activation system, see Navigation, Entertainment, Communication Owner's Manual.

## Help dialog for the voice activation system

Calling up help dialog: ›Help‹

Additional commands for the help dialog:

- ▶ ›Help with examples‹: information about the current operating options and the most important commands for them are announced.
- ▶ ›Help voice activation‹: information about the principle of operation for the voice activation system is announced.

## Example: playing back a CD

### Via the main menu

The commands of the menu items are spoken just as they are selected via the controller.

1. Switch on the Entertainment sound output if necessary.
2.  Press the button on the steering wheel.
3. ›Media menu‹  
The medium last played is played back.
4. ›C D‹
5. ›C D drive‹
6. ›Disc ... Track ...‹, e.g., CD track 4.

## Via short command

Playback of the CD can also be started via a short command.

1. Switch on the Entertainment sound output if necessary.
2.  Press the button on the steering wheel.
3. ›Disc ... Track ...‹, e.g., CD track 4.

## Setting the voice dialog

You can set whether the system should use the standard dialog or a shorter version.

In the shorter variant of the voice dialog, the announcements from the system are issued in an abbreviated form.

1. "Settings"
2. "Language/Units"
3. "Speech type:"
4. Select the setting.

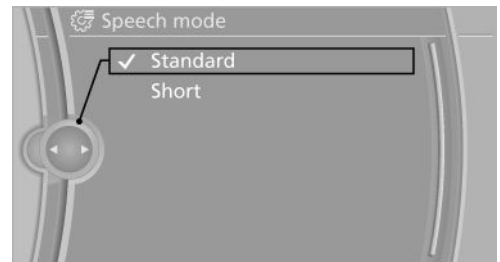

## Adjusting the volume

Turn the volume button while giving an instruction until the desired volume is set.

- ▶ The volume remains constant even if the volume of other audio sources is changed.
- ▶ The volume is stored for the remote control currently in use.

## Hints on Emergency Requests

Do not use the voice activation system to initiate an Emergency Request. In stressful situations, the voice and vocal pitch can change. This can unnecessarily delay the establishment of a telephone connection.

Instead, use the SOS button, refer to page 239, in the vicinity of the interior mirror.

## Environmental conditions

- ▷ Say the commands, numbers, and letters smoothly and with normal volume, emphasis, and speed.
- ▷ Always say commands in the language of the voice activation system.
- ▷ Keep the doors, windows, and glass sunroof closed to prevent noise interference.
- ▷ Avoid making other noise in the vehicle while speaking.

# Integrated Owner's Manual in the vehicle

## Vehicle equipment

All standard, country-specific and optional equipment that is offered in the model series is described in this chapter. Therefore, equipment is also described that is not available in a vehicle, e. g., because of the selected optional equipment or country variant. This also applies for safety-related functions and systems.

## Integrated Owner's Manual in the vehicle

The Integrated Owner's Manual can be displayed on the Control Display. The equipment and functions that are in the vehicle are described therein.

### Components of the Integrated Owner's Manual

The Integrated Owner's Manual consists of three parts, which offer various levels of information or access possibilities.

#### Quick Reference Guide

Located in the Quick Reference is important information for the operation of the vehicle, the operation of basic vehicle functions or for what to do in the event of a flat tire. This information can also be displayed during driving.

#### Search by pictures

Information and descriptions based on illustrations can be searched via search by pictures. This is helpful, for example, if the description of an outfitting package that cannot be named is needed.

#### Owner's Manual

Information and descriptions can be searched by direct entry of a search term via the index.

## Select components

1.  Press the button.
2. Turn the controller: open "Vehicle Info".
3. Press the controller.
4. Selecting desired range:
  - ▷ "Quick reference"
  - ▷ "Search by pictures"
  - ▷ "Owner's Manual"

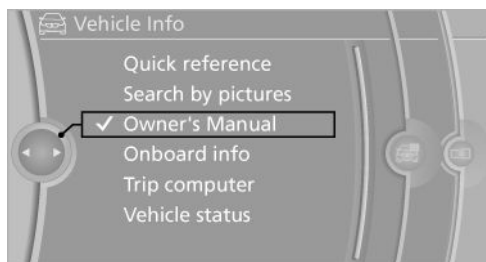

## Leafing through the Owner's Manual

### Page by page with link access

Turn the controller until the next or previous page is displayed.

### Page by page without link access

Leaf through the pages directly while skipping the links.

Highlight the symbol once. Now simply press the controller to leaf from page to page.



Leaf back.



Leaf forward.

## Context help - Owner's Manual to the temporarily selected function

The relevant information can be opened directly.

### Opening via the iDrive

To move directly from the application on the Control Display to the options menu:

-  Press the button or move the controller to the right repeatedly until the "Options" menu is displayed.
- "Display Owner's Manual"



### Opening when a Check Control message is displayed

Directly from the Check Control message on the Control Display:

"Display Owner's Manual"

### Changing between a function and the Owner's Manual

To change from a function, e.g., radio, to the Owner's Manual on the Control Display and to switch between the two displays:

-  Press the button or move the controller to the right repeatedly until the "Options" menu is displayed.
- "Display Owner's Manual"
- Select the desired page in the Owner's Manual.
-  Press the button again to return to the function displayed last.
-  Press the button to return to the page of the Owner's Manual displayed last.

To switch back and forth repeatedly between the function displayed last and the page of the Owner's Manual displayed last, repeat steps 4 and 5. This opens a new panel every time.

## Programmable memory buttons

### General information

The Owner's Manual can be stored on the programmable memory buttons and called up directly.

### Storing

- "Owner's Manual" Select via the iDrive.
-  Press the desired button for more than 2 seconds.

### Executing

-  Press the button.  
The Owner's Manual is displayed immediately.







## Controls

This chapter is intended to provide you with information that will give you complete control of your vehicle. All features and accessories that are useful for driving and your safety, comfort and convenience are described here.

# Opening and closing

## Vehicle equipment

All standard, country-specific and optional equipment that is offered in the model series is described in this chapter. Therefore, equipment is also described that is not available in a vehicle, e. g., because of the selected optional equipment or country variant. This also applies for safety-related functions and systems.

## Remote control/key

### Buttons on the remote control

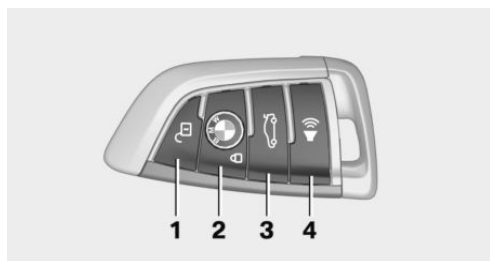

- 1 Unlocking
- 2 Locking
- 3 Opening the tailgate
- 4 Panic mode

### General information

The vehicle is supplied with two remote controls with keys.

Every remote control contains a replaceable battery.

The settings called up and implemented when the car is unlocked depend on which remote control is used to unlock the car. Personal Profile, refer to page 35.

Information on the required maintenance is stored in the remote control as well. Service data in the remote control, refer to page 229

### Integrated key

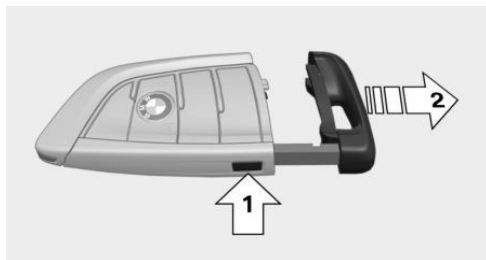

Press the button on the back of the remote control, arrow 1, and pull out the key, arrow 2.

The integrated key fits the following locks:

- ▷ Driver's door.
- ▷ Glove compartment on the front passenger side.

### Replacing the battery

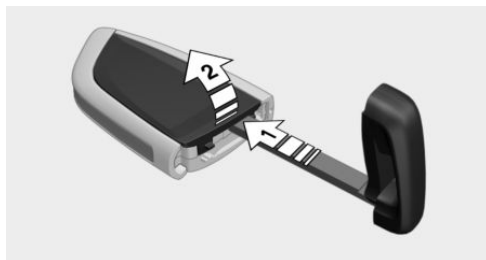

1. Take the integrated key out of the remote control.
2. Push in the catch with the key, arrow 1.
3. Remove the cover of the battery compartment, arrow 2.
4. Insert a battery of the same type with the positive side facing upwards.
5. Press the cover closed.



Take the used battery to a recycling center or to your service center.

## New remote controls

New remote controls are available from the service center.

## Loss of the remote controls

Lost remote controls can be blocked by your service center.

## Emergency detection of remote control

It is possible to switch on the ignition or start the engine in situations such as the following:

- ▷ Interference of radio transmission to remote control by external sources.
- ▷ Discharged battery in the remote control.
- ▷ Interference of radio transmission by mobile devices in close proximity to the remote control.
- ▷ Interference of radio transmission by charger while charging items such as mobile devices in the vehicle.

A Check Control message is displayed if an attempt is made to switch on the ignition or start the engine.

## Starting the engine with emergency detection of the remote control

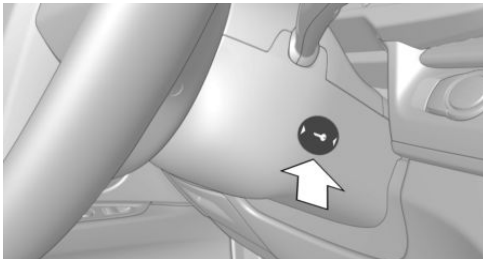

If a corresponding Check Control message appears, hold the remote control vertically against the marked area on the steering column and press the Start/Stop button within 10 seconds while pressing the brake.

## Personal Profile

### The concept

You can set several of your vehicle's functions to suit your personal needs and preferences.

- ▷ The settings are automatically saved in the profile currently activated.
- ▷ The remote control used is detected when the vehicle is unlocked and the stored profile is called up.
- ▷ Your personal settings will be recognized and called up again even if the vehicle has been used in the meantime by someone else with another remote control.

The individual settings are stored for three Personal Profiles and one guest profile.

### Transmitting the settings

Your personal settings can be taken with you to another vehicle equipped with the Personal Profile function. Additional information is available from the service center.

Transmission takes place via:

- ▷ The USB interface in the center armrest onto a USB device.
- ▷ BMW Online.

## Profile management

### Opening the profiles

A different profile can be called up than the one associated with the remote control currently in use.

1. "Settings"
2. "Profiles"
3. Select a profile.

Called up profile is assigned to the remote control being used at the time.

## Renaming profiles

1. "Settings"
2. "Profiles"  
The current profile is selected.
3. Open "Options".
4. "Rename current profile"

## Resetting profiles

The settings of the active profile are reset to their default values.

1. "Settings"
2. "Profiles"  
The current profile is selected.
3. Open "Options".
4. "Reset current profile"

## Importing profiles

Existing settings and contacts are overwritten with the imported profile.

1. "Settings"
2. "Profiles"
3. "Import profile"
4. BMW Online: "BMW Online"  
USB interface, refer to page 179: "USB device"

## Exporting profiles

Most settings of the active profile and the saved contacts can be exported.

This can be helpful for securing and retrieving personal settings, before delivering the vehicle to a workshop for example.

1. "Settings"
2. "Profiles"
3. "Export profile"
4. BMW Online: "BMW Online"  
USB interface, refer to page 179: "USB device"

## Using the guest profile

The guest profile can be used to make individual settings without affecting the three Personal Profiles.

This can be useful for drivers who are using the vehicle temporarily and do not have their own profile.

1. "Settings"
2. "Profiles"  
The current profile is selected.
3. Open "Guest".
4. Create the settings.

Note: the guest profile cannot be renamed.

## Display profile list during start

The profile list can be displayed during each start for selecting the desired profile.

1. "Settings"
2. "Profiles"
3. Open "Options".
4. "Display user list at startup"

## Personal Profile settings

The following functions and settings can be stored in a profile.

- ▷ Collision warning: warning time.
- ▷ Exterior mirror position.
- ▷ CD/Multimedia: audio source listened to last.
- ▷ Unlocking/locking of the vehicle: settings.
- ▷ Driving Dynamics Control: sport program.
- ▷ Driver's seat position: automatic retrieval after unlocking.
- ▷ Programmable memory buttons: assignment.
- ▷ Head-up Display: selection, brightness, position and rotation of the display.
- ▷ Headlamp courtesy delay feature: time setting.

- ▷ Tone: tone settings.
- ▷ Automatic climate control: settings.
- ▷ Steering wheel position.
- ▷ Navigation: map views, route criteria, voice output on/off.
- ▷ Night Vision with pedestrian detection.
- ▷ Intelligent Safety: individual settings.
- ▷ Park Distance Control PDC: adjusting the signal tone volume.
- ▷ Radio: stored stations, station listened to last, special settings.
- ▷ Rearview camera: selection of functions and type of display.
- ▷ Side View: selection of the display type.
- ▷ Language on the Control Display.
- ▷ Lane departure warning: last setting, on/off.
- ▷ Active Blind Spot Detection: last setting, on/off.
- ▷ Daytime running lights: current setting.
- ▷ Triple turn signal activation.
- ▷ Locking the vehicle: after a brief period or after starting to drive.

## Central locking system

### The concept

The central locking system becomes active when the driver's door is closed.

The system simultaneously engages and releases the locks on the following:

- ▷ Doors.
- ▷ Tailgate.
- ▷ Fuel filler flap.

### Operating from the outside



- ▷ Via the remote control.
- ▷ Via the door handles.
- ▷ Via the button on the tailgate.

The following takes place simultaneously when locking/unlocking the vehicle via the remote control:

- ▷ Depending on how the vehicle is equipped, the theft protection is activated/deactivated. Theft protection prevents the doors from being unlocked using the lock buttons or the door opener.
- ▷ The welcome lamps, interior lamps and courtesy lamps are switched on and off.
- ▷ The alarm system, refer to page 45, is armed or disarmed.

### Operating from the inside



- ▷  Press the button.  
The vehicle is unlocked.
- ▷  Press the button.  
Vehicle is locked.

If the vehicle has been locked from inside, the fuel filler flap remains unlocked.

If an accident of a certain severity occurs, the central locking system unlocks automatically.

The hazard warning system and interior lamps come on.

## Opening and closing: from the outside

### Using the remote control

#### General information



Take the remote control with you. People or animals left unattended in a parked vehicle can lock the doors from the inside. Always take the remote control with you when leaving the vehicle so that the vehicle can then be opened from the outside. ◀

#### Unlocking



Press the button on the remote control.

The vehicle is unlocked.

Welcome lamps, interior lamp and courtesy lamps are switched on.

You can set how the vehicle is to be unlocked. Create the settings, refer to page 44.

#### Convenient opening

The remote control can be used to simultaneously open the windows and the glass sunroof.



Press and hold the button on the remote control.

The windows and the glass sunroof open.

Releasing the button stops the motion.

#### Locking



Press the button on the remote control.



**Locking from the outside**  
Do not lock the vehicle from the outside if there are people in it, as the vehicle cannot be unlocked from inside without special knowledge. ◀

### Switching on interior lamps and courtesy lamps



Press the button on the remote control with the vehicle locked.

If the button is pressed again within 10 seconds of when the vehicle was locked Interior motion sensor and tilt alarm sensor of the anti-theft warning system, refer to page 46, are switched off. After locking, wait 10 seconds before interior lamps and courtesy lamps are switched on.

#### Panic mode

You can trigger the alarm system if you find yourself in a dangerous situation.



Press the button on the remote control for at least 3 seconds.

To switch off the alarm: press any button.

#### Opening the tailgate



Press the button on the remote control for approx. 1 second and release.

The tailgate opens automatically, regardless of whether it was previously locked or unlocked.

The tailgate pivots back and up when it opens. Ensure that adequate clearance is available before opening.

This button can also be used to unlock the doors. The button assignment on the remote control can be set variously depending on how the vehicle is equipped and according to the country-specific variant.

In some vehicle equipment variants, the tailgate can only be opened using the remote control if the vehicle has been unlocked.



**Do not place the remote control in the cargo area**

Take the remote control with you and do not leave it in the cargo area; otherwise, the remote control is locked inside the vehicle when the tailgate is closed. ◀

The tailgate is locked again as soon as it is pushed closed.



#### Provide edge protection

Sharp or angular objects can hit the rear window while driving and damage the heating wires of the rear window. Provide edge protection. ◀

## Malfunction

If the vehicle can no longer be locked or unlocked with the remote control, the battery may be discharged or there may be interference from external sources such as mobile phones, metal objects, overhead power lines, transmission towers, etc.

If this occurs, lock or unlock the driver's door at the door lock using the integrated key.

## For US owners only

The transmitter and receiver units comply with part 15 of the FCC/Federal Communication Commission regulations. Operation is governed by the following:

FCC ID:

- ▶ LX8766S.
- ▶ LX8766E.
- ▶ LX8CAS.
- ▶ LX8CAS2.
- ▶ MYTCAS4.

Compliance statement:

This device complies with part 15 of the FCC Rules. Operation is subject to the following two conditions:

- ▶ This device may not cause harmful interference, and
- ▶ this device must accept any interference received, including interference that may cause undesired operation.

Any unauthorized modifications or changes to these devices could void the user's authority to operate this equipment.

## Using the door lock

### General information



#### Locking from the outside

Do not lock the vehicle from the outside if there are people in it, as the vehicle cannot be unlocked from inside without special knowledge. ◀

The alarm system is triggered when the door is opened, if the vehicle is unlocked via the door lock.

In order to terminate this alarm, unlock vehicle with the remote control or switch on the ignition, if necessary, by emergency detection of the remote control.

Only the driver's door is unlocked or locked via the door lock.

## Locking the doors and tailgate at once

To lock all doors and the tailgate at once:

1. With the doors closed, lock the vehicle using the button for the central locking system in the interior.
2. Unlock and open the driver's or front passenger door.
3. Lock the vehicle.
  - ▶ Lock the driver's door using the integrated key in the door lock, or
  - ▶ Press down the lock button of the front passenger door and close the door from the outside.

The fuel filler flap can only be locked using the remote control.

## Manual operation

If an electrical malfunction occurs, lock or unlock the vehicle using the integrated key via the door lock on the driver's door.

1. Integrated key in opening, arrow, press and remove cover.

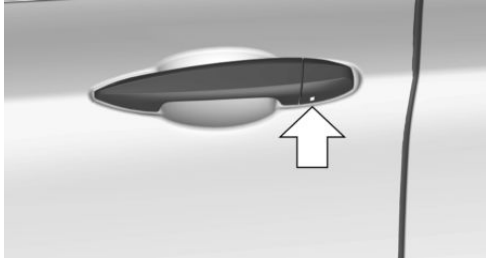



2. Unlock or lock the driver's door using the integrated key in the door lock, or

## Opening and closing: from the inside

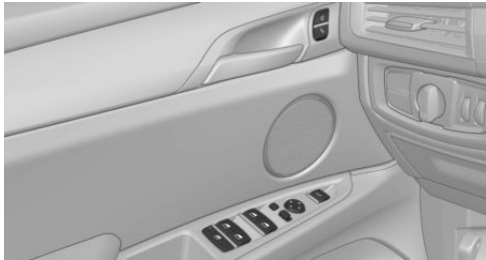
### Locking and unlocking



- ▷  Press the button.  
Vehicle is locked.
- ▷  Press the button.  
The vehicle is unlocked.

Pressing the buttons locks and unlocks the doors and the tailgate when the front doors are closed, but they are not secured against theft.

The fuel filler flap remains unlocked.

## Unlocking and opening

- ▷ Either unlock the doors together using the button for the central locking system and then pull the door handle above the armrest or
- ▷ Pull the door opener on the door to be opened. The other doors remain locked.  
To open the rear doors individually, pull the door opener twice: the first time unlocks them, the second time opens them.

## Doors

### Automatic Soft Closing

To close the doors, push lightly.

It is closed automatically.



Danger of pinching

Make sure that the closing path of the doors is clear; otherwise, injuries may result. ◀

## Top tailgate

### Automatic tailgate operation

### Adjusting the opening height

You can set how far the tailgate should open.



Adjusting the opening height

When adjusting the opening height, ensure that there is a clearance of at least 4 in/10 cm above the tailgate. Otherwise, the ceiling may not be high enough for the open tailgate if the load situation changes. ◀

1. "Settings"
2. "Tailgate"
3. Turn the controller until the desired opening height is selected.



## Opening

The tailgate opens until it reaches the set height.



Note the opening height of the tailgate

The tailgate pivots back and up when it opens. Ensure that there is sufficient clearance when the tailgate opens; otherwise, damage may result.

Adjust the opening height of the tailgate according to the given situation. ◀

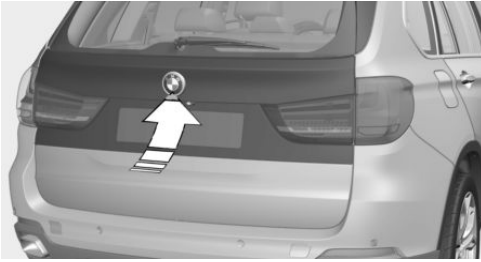

- ▶ Press the button on the exterior of the tailgate.
- ▶  Press the button on the remote control for approx. 1 second.

This button can also be used to unlock the doors. The button assignment on the remote control can be set variously depending on how the vehicle is equipped and according to the country-specific variant.

- ▶  Press the button in the driver's door.

The tailgate is opened if the vehicle is stationary, provided that the tailgate has not been locked.

Pressing the button again stops the motion.

The opening process is interrupted as well:

- ▶ When starting the engine.
- ▶ When the vehicle starts moving.
- ▶ By pressing the button in the driver's door.
- ▶ By pressing the button on the inside of the tailgate.



Provide edge protection

Sharp or angular objects can hit the rear window while driving and damage the heating wires of the rear window. Provide edge protection. ◀

## Closing

The lower tailgate must be closed; otherwise, a Check Control message is output.

The floor panel in the cargo area must be folded down; otherwise, the tailgate cannot be closed.

Without Comfort Access:



- ▶ Press the button on the inside of the tailgate.  
The tailgate closes automatically.  
Pressing again stops the motion.

With Comfort Access:





- ▶ Press the button, arrow 1, on the inside of the tailgate.  
The tailgate closes automatically.  
Pressing again stops the motion.
- ▶ Press the button, arrow 2.

Tailgate closes automatically and the vehicle is locked.



- ▶ Press the button on the exterior of the tailgate.  
Pressing again stops the motion.

- ▶  Press and hold the button on the remote control in the area close to the vehicle.  
An acoustic signal sounds, releasing the button stops the motion.

- ▶  Pull and hold the button in the driver door. The remote control must be located in the interior for this function.  
An acoustic signal sounds and the tailgate closes.

The closing operation is interrupted:

- ▶ When starting the engine.
- ▶ The vehicle starts off with jerks.

 Keep the closing path clear  
Make sure that the closing path of the tailgate is clear; otherwise, injuries may result.◀

 Monitor the closing process  
Monitor the closing process to ensure that no one becomes trapped.◀

 Do not place the remote control in the cargo area

Take the remote control with you and do not leave it in the cargo area; otherwise, the re-

mote control is locked inside the vehicle when the tailgate is closed.◀

### Manual operation

In the event of an electrical malfunction, manually unlock and the tailgate and move it slowly and smoothly.

 Do not operate the tailgate manually if it is blocked

If the tailgate is blocked, do not operate it manually as the tailgate may otherwise become damaged and injury may result.

Contact your service center.◀



1. Fold the rear seat backrest forward.
2. In the lower tailgate, loosen and remove the cover using the onboard tool kit or a suitable object.
3. Pull the plastic hose in the direction of the interior.  
The tailgate is unlocked.
4. Open the top tailgate, and press the plastic hose back in.
5. Insert and close the cover.

The tailgate is locked again as soon as it is closed.

## Lower tailgate

### Opening

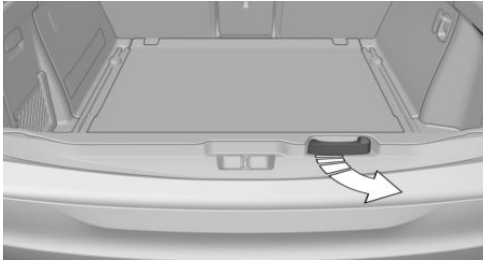

Pull the lever and swing down the tailgate. The open tailgate can be loaded with up to 550 lbs/250 kg.

### Closing

Swing up the tailgate, and press it closed.

## Comfort Access

### The concept

The vehicle can be accessed without activating the remote control.

All you need to do is to have the remote control with you, e.g., in your jacket pocket.

The vehicle automatically detects the remote control when it is nearby or in the passenger compartment.

Comfort Access supports the following functions:

- ▷ Unlocking/locking of the vehicle.
- ▷ Convenient closing.
- ▷ Unlocking of the tailgate separately.
- ▷ Start the engine.

### Functional requirements

- ▷ There are no external sources of interference nearby.
- ▷ To lock the vehicle, the remote control must be located outside of the vehicle.

- ▷ The next unlocking and locking cycle is not possible until after approx. 2 seconds.
- ▷ The engine can only be started if the remote control is in the vehicle.

### Comparison with ordinary remote control

The functions can be controlled by pressing the buttons of the remote control or Comfort Access.

### Unlocking

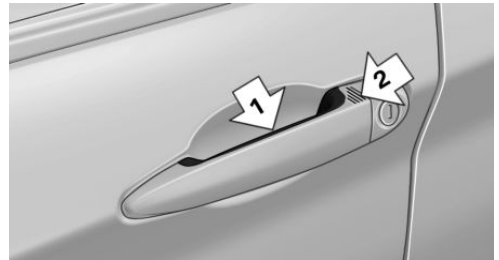

Fully grasp a door handle, arrow 1.

This corresponds to pressing the  button on the remote control.

### Locking

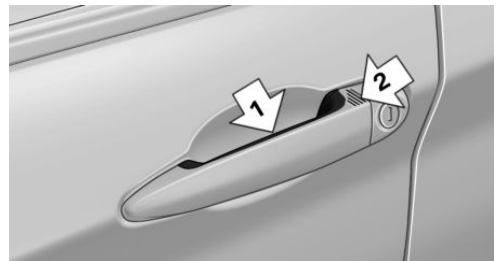

Press the area on the door handle, arrow 2, with your finger for approx. 1 second.

This corresponds to pressing the  button on the remote control.

To save battery power, ensure that the ignition and all electronic systems and/or power con-

sumers are switched off before locking the vehicle.

### Convenient closing

Press the area on the door handle, arrow 2, with the finger and hold it down.

In addition to locking, the windows and the glass sunroof are closed.



Monitor the closing process

Monitor the closing process to ensure that no one becomes trapped. ◀

### Unlocking the tailgate separately

Press the button on the exterior of the tailgate.

This corresponds to pressing the  button on the remote control.



Do not place the remote control in the cargo area

Take the remote control with you and do not leave it in the cargo area; otherwise, the remote control is locked inside the vehicle when the tailgate is closed. ◀

### Malfunction

Comfort Access may not function properly if it experiences interference from external sources such as mobile phones, metal objects, overhead power lines, transmission towers, etc.

In this case, open or close the vehicle using the buttons on the remote control or use the integrated key in the door lock.

## Adjusting

### Unlocking

The setting is stored for the remote control currently in use.

1. "Settings"
2. "Doors/key"

3.  Select symbol or "Unlock button:"

4. Select the desired function:

- ▷ "Driver's door only"

Only the driver's door and the fuel filler flap are unlocked. Pressing again unlocks the entire vehicle.

- ▷ "All doors"

The entire vehicle is unlocked.

Depending on how the vehicle is equipped or the country-specific variant, you can set whether the doors are also unlocked with the  button on the remote control.

### Confirmation signals from the vehicle

The setting is stored for the remote control currently in use.

1. "Settings"
2. "Doors/key"
3. Deactivate or activate the desired confirmation signals.
  - ▷ "Acoustic sig. lock/unlock"
  - ▷ "Flash when lock/unlock"

### Automatic locking

The setting is stored for the remote control currently in use.

1. "Settings"
2. "Doors/key"
3. Select the desired function:
  - ▷ "Lock if no door is opened"
 

The vehicle locks automatically after a short period of time if a door is not opened.
  - ▷ "Lock after start driving"
 

The vehicle locks automatically after you drive away.

## Retrieving the seat, mirror, and steering wheel settings

The driver's seat, exterior mirror, and steering wheel positions selected last are stored for the currently used remote control.

When the vehicle is unlocked, these positions are automatically retrieved if this function was activated.



Pinch hazard when moving back the seat

If this function is used, first make sure that the footwell behind the driver's seat is empty. Otherwise, people can be injured or objects damaged when the seat is moved back. ◀

The adjustment procedure is interrupted:

- ▷ When a seat position switch is pressed.
- ▷ When a button of the seat, mirror, and steering wheel memory is pressed briefly.

## Activating the setting

1. "Settings"
2. "Doors/key"
3. "Last seat position autom."

## Alarm system

### The concept

The vehicle alarm system responds to:

- ▷ Opening of a door, the hood or the tailgate.
- ▷ Movements in the vehicle.
- ▷ Changes in the vehicle tilt, e.g., during attempts to steal a wheel or when towing the car.
- ▷ Interruptions in battery voltage.

The alarm system briefly indicates tampering:

- ▷ By sounding an acoustic alarm.
- ▷ By switching on the hazard warning system.
- ▷ By flashing the high beams.

## Arming and disarming the alarm system

### General information

When you lock or unlock the vehicle, either with the remote control or via the Comfort Access at the door lock, the alarm system is armed or disarmed at the same time.

### Door lock and armed alarm system

The alarm system is triggered when the door is opened, if the vehicle is unlocked via the door lock.

In order to terminate this alarm, unlock vehicle with the remote control or switch on the ignition, if necessary, by emergency detection of the remote control.

### Tailgate and armed alarm system

The tailgate can be opened even when the alarm system is armed.



Press the button on the remote control for approx. 1 second.

After the tailgate is closed, it is locked and monitored again if the doors are locked. The hazard warning system flashes once.

In some vehicle equipment variants, the tailgate can only be opened using the remote control if the vehicle was unlocked first.

### Panic mode

You can trigger the alarm system if you find yourself in a dangerous situation.



Press the button on the remote control for at least 3 seconds.

To switch off the alarm: press any button.

### Switching off the alarm

To terminate the alarm:

- ▷ Unlock the vehicle using the remote control.

- ▶ With Comfort Access: If you are carrying the remote control with you, grasp the driver side or front passenger side door handle completely.

### Indicator lamp on the interior rearview mirror

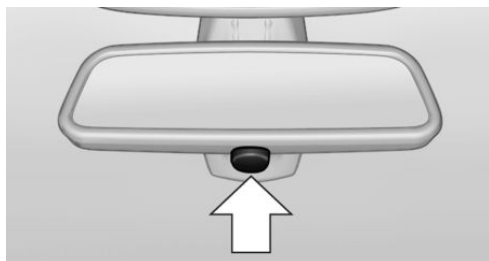

- ▶ The indicator lamp flashes briefly every 2 seconds:  
The system is armed.
- ▶ The indicator lamp flashes after locking:  
The doors, hood or tailgate is not closed properly, but the rest of the vehicle is secured.  
After 10 seconds, the indicator lamp flashes continuously. Interior motion sensor and tilt alarm sensor are not active.
- ▶ The indicator lamp goes out after unlocking:  
The vehicle has not been tampered with.
- ▶ The indicator lamp flashes after unlocking until the engine ignition is switched on, but no longer than approx. 5 minutes:  
An alarm has been triggered.

### Tilt alarm sensor

The tilt of the vehicle is monitored.

The alarm system responds in situations such as attempts to steal a wheel or when the car is towed.

### Interior motion sensor

The windows and glass sunroof must be closed for the system to function properly.

### Avoiding unintentional alarms

The tilt alarm sensor and interior motion sensor can be switched off together, such as in the following situations:

- ▶ In automatic car washes.
- ▶ In duplex garages.
- ▶ During transport on car-carrying trains, at sea or on a trailer.
- ▶ When animals are to remain in the vehicle.

### Switching off the tilt alarm sensor and interior motion sensor



Press the remote control button again within 10 seconds as soon as the vehicle is locked.

The indicator lamp lights up for approx. 2 seconds and then continues to flash.

The tilt alarm sensor and interior motion sensor are switched off until the vehicle is locked again.

## Power windows

### General information



Take the remote control with you

Take the remote control with you when leaving the vehicle so that children, for example, cannot operate the power windows and injure themselves. ◀



## Opening

- ▶  Press the switch to the resistance point.

The window opens while the switch is held.

- ▶  Press the switch beyond the resistance point.



The window opens automatically.

Pressing the switch again stops the motion.

Convenient opening, refer to page 38, via the remote control.

## Closing

-  Keep the closing path clear
- Monitor the closing process and make sure that the closing path of the window is clear; otherwise, injuries may result. ◀

- ▶  Pull the switch to the resistance point.
- The window closes while the switch is held.
- ▶  Pull the switch beyond the resistance point.
- The window closes automatically.
- Pressing the switch stops the motion.

## Pinch protection system

If the closing force exceeds a specific value as a window closes, the closing action is interrupted.

The window reopens slightly.

-  Danger of pinching even with pinch protection

Even with the pinch protection system, check that the window's closing path is clear; otherwise, the closing action may not stop in certain situations, e.g., if thin objects are present. ◀

-  No window accessories
- Do not install any accessories in the range of movement of the windows; otherwise, the pinch protection system will be impaired. ◀

## Closing without the pinch protection system

-  Keep the closing path clear
- Monitor the closing process and make sure that the closing path of the window is clear; otherwise, injuries may result. ◀

For example, if there is an external danger or if ice on the windows prevents a window from closing normally, proceed as follows:

1. Pull the switch past the resistance point and hold it there.
- The pinch protection is limited and the window reopens slightly if the closing force exceeds a certain value.
2. Pull the switch past the resistance point again within approx. 4 seconds and hold it there.
- The window closes without pinch protection.

## Safety switch

The safety switch in the driver's door can be used to prevent children, for example, from opening and closing the rear windows using the switches in the rear.

## Switching on and off

-  Press the button.

The LED lights up if the safety function is switched on.

-  **Safety switch for rear operation**  
Press the safety switch when transporting children in the rear; otherwise, injury may result if the windows are closed without supervision. ◀

## Roller sunblinds

### Roller sunblinds for the rear side windows

Pull out the roller sunblind at the loop and hook it onto the bracket.

-  Do not open the window while the roller sunblind is raised.

Do not open the window while the roller sunblind is raised; otherwise, there is a risk of damage at high speeds that may result in personal injury. ◀

## Panoramic-glass sunroof

### General information

The glass sunroof and the sliding visor can be operated together or separately, using the same switch.

The glass sunroof is operational when the ignition is switched on.

-  **Keep the closing path clear**  
Monitor the closing process and make sure that the closing path of the glass sunroof is clear; otherwise, injuries may result. ◀

-  **Take the remote control with you**  
Take the remote control with you when leaving the vehicle so that children, for example, cannot operate the roof and injure themselves. ◀



### Tilting the glass sunroof



Push switch upward briefly.

- ▷ The closed roof is tilted and the sliding visor opens slightly.
- ▷ The opened roof closes until it is in its tilted position. The sliding visor stays completely open.

### Opening/closing the sliding visor

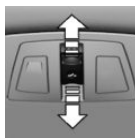

- ▷ Press the switch in the desired direction to the resistance point and hold it there.  
The sliding visor moves while the switch is being held.

- ▷ Press the switch in the desired direction past the resistance point.  
The sliding visor moves automatically. Pressing the switch again stops the motion.

### Opening/closing the glass sunroof

When the sliding visor is open, proceed as described under Sliding visor.



## Opening/closing the glass sunroof and sliding visor together

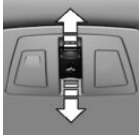

Briefly press the switch twice in succession in the desired direction past the resistance point.

The glass sunroof and sliding visor move together. Pressing the switch again stops the motion.

Convenient operation, refer to page 38, via the remote control.

Convenient closing, refer to page 44, with Comfort Access.

### Comfort position

Stops the roof in the comfort position if the roof is not fully open. This reduces wind noise in the passenger compartment.

If desired, continue the movement by pressing the switch.

### Pinch protection system

If the closing force when closing the glass sunroof exceeds a certain value, the closing movement is stopped, beginning at approximately the middle of the opening in the roof, or from the tilted position during closing.

The glass sunroof opens again slightly.



**Danger of pinching even with pinch protection**

Despite the pinch protection system, check that the roof's closing path is clear; otherwise, the closing action may not be interrupted in certain extreme situations, such as when thin objects are present. ◀

### Closing from the open position without pinch protection

For example, if there is an external danger, proceed as follows:

1. Press the switch forward beyond the resistance point and hold.

Pinch protection is limited and the roof re-opens slightly if the closing force exceeds a certain value.

2. Press the switch forward again beyond the resistance point and hold until the roof closes without pinch protection. Make sure that the closing area is clear.

### Closing from the raised position without pinch protection

If there is an external danger, push the switch forward past the resistance point and hold it.

The roof closes without pinch protection.

### Initializing after a power failure

After a power failure during the opening or closing process, the roof can only be operated to a limited extent.

### Initializing the system

The system can be initialized when the vehicle is stationary and the engine is running.

During the initialization, the roof closes without pinch protection.



**Keep the closing path clear**

Monitor the closing process and make sure that the closing path of the glass sunroof is clear; otherwise, injuries may result. ◀

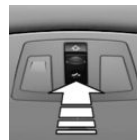

Press the switch up and hold it until the initialization is complete:

- ▷ Initialization begins within 15 seconds and is completed when the sunroof and sliding visor are completely closed.
- ▷ The roof closes without pinch protection.

# Adjusting

## Vehicle equipment

All standard, country-specific and optional equipment that is offered in the model series is described in this chapter. Therefore, equipment is also described that is not available in a vehicle, e. g., because of the selected optional equipment or country variant. This also applies for safety-related functions and systems.

## Sitting safely

The ideal seating position can make a vital contribution to relaxed, fatigue-free driving.

The seating position plays an important role in an accident in combination with:

- ▷ Safety belts, refer to page 55.
- ▷ Head restraints, refer to page 57.
- ▷ Airbags, refer to page 104.

## Front seats

### General information

 Do not adjust the seat while driving  
Do not adjust the driver's seat while driving, or the seat could respond with unexpected movement and the ensuing loss of vehicle control could lead to an accident. ◀

 Do not incline the backrest too far to the rear

Also on the front passenger side, do not incline the backrest on the front passenger side too far to the rear during driving, or there is a risk of slipping under the safety belt in the event of an accident. This would eliminate the protection normally provided by the belt. ◀

## Semi-electrically adjustable seats

### At a glance

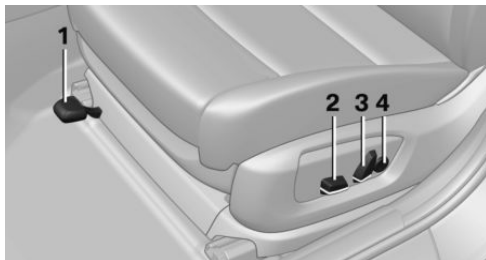

- 1 Forward/backward
- 2 Height, tilt
- 3 Backrest
- 4 Lumbar support

### Tilt

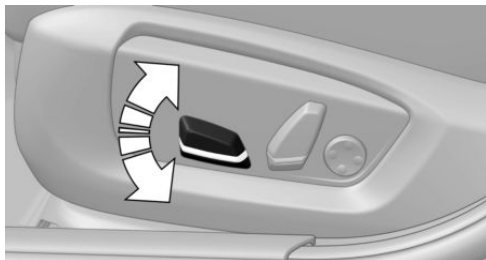

Move the control in the desired direction until the desired tilt is set. After releasing the control, apply your weight to the seat or lift it off to make sure the seat engages properly.

## Forward/backward

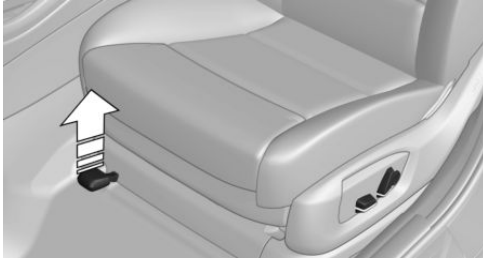

Pull the lever and slide the seat in the desired direction.

After releasing the control, move the seat forward or back slightly to make sure it engages properly.

## Height

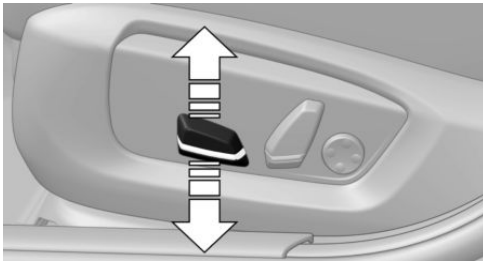

Move the button in the required direction.

## Backrest

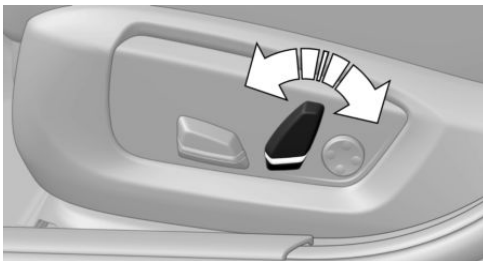

Move the button in the required direction.

## Electrically adjustable seats

### At a glance

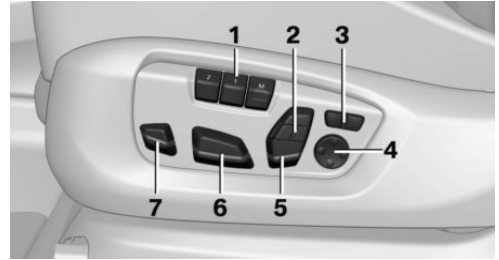

- 1 Seat, mirror, and steering wheel memory
- 2 Shoulder support
- 3 Backrest width
- 4 Lumbar support
- 5 Backrest
- 6 Forward/back, height, tilt
- 7 Thigh support

### Note

The seat setting for the driver's seat is stored for the remote control currently in use. When the vehicle is unlocked via the remote control, the position is automatically retrieved if the Function, refer to page 45, for this is activated.

### Adjustments in detail

1. Forward/backward

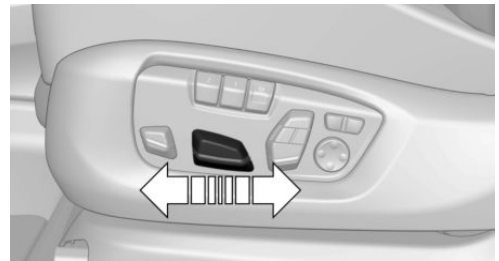

2. Height

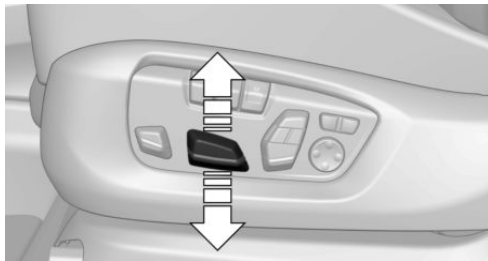

3. Seat tilt



4. Backrest tilt



Thigh support

Multifunction seat

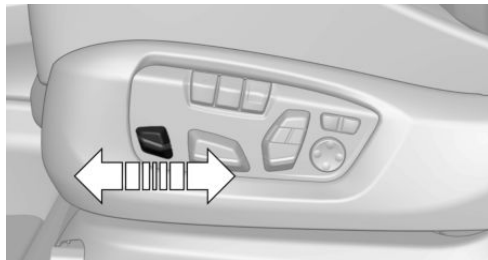

Adjust the position using the lever.

Sport seat

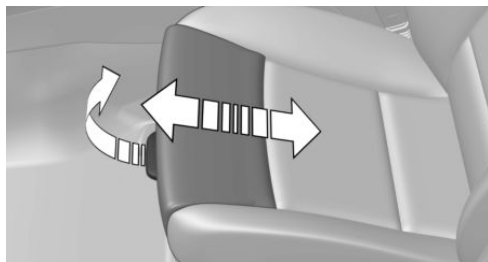

Pull the lever at the front of the seat and adjust the thigh support.

Lumbar support

The curvature of the seat backrest can be adjusted in such a way that it supports the lumbar region of the spine. The lower back and the spine are supported for upright posture.



- ▶ Press the front/rear section of the switch.  
The curvature is increased/decreased.
- ▶ Press the upper/lower section of the switch.  
The curvature is shifted up/down.

## Backrest width



Change the width of the backrest using the side wings to adjust the lateral support.

## Shoulder support



Also supports the back in the shoulder area:

- Results in a relaxed seating position.
- Reduces strain on the shoulder muscles.

## Front seat heating



### Switching on



Press the button once for each temperature level.

The maximum temperature is reached when three LEDs are lit.

If the drive is continued within approx. 15 minutes, the seat heating is activated automatically with the temperature selected last.

### Switching off



Press the button longer.  
The LEDs go out.

## Temperature distribution

The heating action in the seat cushion and backrest can be distributed in different ways.

1. "Climate"
2. "Front seat heating"
3. Select the required seat.
4. Turn the controller to set the temperature distribution.

## Active seat ventilation, front

The seat cushion and backrest surfaces are cooled by means of integrated fans.

The ventilation cools the seat, e. g., if the vehicle interior is overheated or for continuous cooling at high temperatures.



### Switching on



Press the button once for each ventilation level.

The highest level is active when three LEDs are lit.

After a short time, the system automatically moves down one level in order to prevent excessive cooling.

### Switching off



Press the button longer.

The LEDs go out.

## Rear seats

### Second row of seats

#### Hints

 Center armrest  
When folding down the center armrest, ensure that the area below the center head restraint is clear. Otherwise, injury may result. ◀

 Do not adjust the seat while driving  
Do not adjust the seat while the vehicle is moving, otherwise, the restraining effect of the seat can be limited in an accident. ◀

 Keep the floor area under the second row of seats clear

When you fold back the second row of seats, make sure that the floor area under the second row of seats is clear. Otherwise, persons who are located in the third row of seats could be injured or objects could be damaged. ◀

 Fold back and lock the second row of seats

Before starting off, fold back and lock the second row of seats; otherwise, people can be injured or objects damaged. ◀

#### Forward/backward

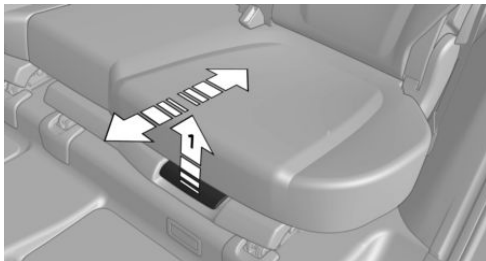

1. Pull the lever, arrow 1, and slide the seat in the desired direction.

2. Release lever and move seat slightly forward or back to get it to latch in place.

#### Backrest tilt

The backrest tilt can be adjusted to six settings.

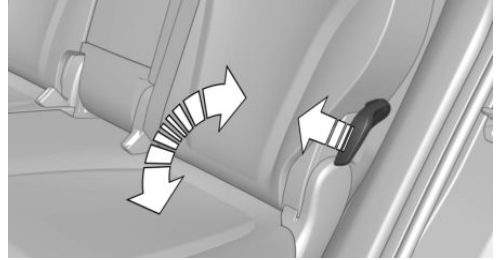

Pull the lever, and apply your weight to the backrest or lift it off, as necessary.

#### Access to the third row of seats

1. Make sure that the middle section is folded up.

When the middle section is folded down, comfortable entry is not possible.



2. Pull the lever and fold the seat forward.

The recessed grip on the inside trim of the door pillar makes getting into the vehicle easier.

If the second row of seats is not locked, a warning symbol is displayed in the instrument cluster.

## Rear seat heating



### Switching on



Press the button once for each temperature level.

The maximum temperature is reached when three LEDs are lit.

If the drive is continued within approx. 15 minutes, the seat heating is activated automatically with the temperature selected last.

### Switching off



Press the button longer.  
The LEDs go out.

## Third row of seats

### General information

The third row of seats is divided and offers space for two people.

### Folding up the backrest



Ensure that the lock is securely engaged

Make sure that the lock engages correctly. If it is not properly engaged, transported cargo could enter the passenger compartment even during braking or evasive maneuvers and endanger the vehicle occupants. ◀

Before folding up the backrest, remove the cargo cover, refer to page 180. If necessary, slide the second row of seats forward a little.

1. Pull the lever, arrow, to unlock the backrest.

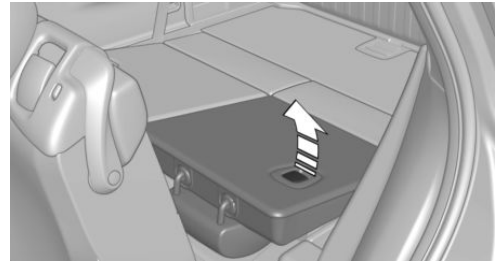

2. Fold up and latch the backrest.
3. Slide headrests into the highest position.

### Folding the backrest down

1. Moving the headrest down.
2. Pull the lever, arrows, to unlock the backrest.



3. Fold the backrest down.

## Safety belts

### Seats with safety belt

The vehicle has five or seven seating positions, each of which is equipped with a safety belt.

### Hints

Always make sure that safety belts are being worn by all occupants before driving away.

To protect the occupants, the belt locking triggers early. Slowly guide the belt out of the holder when applying it.

Although airbags enhance safety by providing added protection, they are not a substitute for safety belts.

- ▷ The shoulder strap's anchorage point will be correct for adult seat occupants of every build if the seat is correctly adjusted.
- ▷ The two outer safety belt buckles, integrated into the 2nd row of seats, are for passengers sitting on the left and right.
- ▷ The center belt buckle of the 2nd row of seats is solely intended for the center passenger.
- ▷ The safety belt buckles, integrated into the 3rd row of seats, are for passengers sitting on the left and right.



#### One person per safety belt

Never allow more than one person to wear a single safety belt. Never allow infants or small children to ride on a passenger's lap. ◀



#### Putting on the belt

Lay the belt, without twisting, snugly across the lap and shoulders, as close to the body as possible. Make sure that the belt lies low around the hips in the lap area and does not press on the abdomen. Otherwise, the belt can slip over the hips in the lap area in a frontal impact and injure the abdomen.

The safety belt must not lie across the neck, rub on sharp edges, be routed over breakable objects, or be pinched. ◀



#### Reduction of restraining effect

Avoid wearing bulky clothing, and pull the shoulder belt periodically to readjust the tension. Make sure that the belt is not jammed; otherwise, the belt can be damaged and the restraining effect reduced. ◀

## Buckling the belt

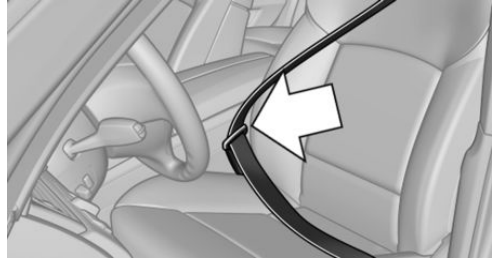

Make sure you hear the latch plate engage in the belt buckle.

To ease accessibility to the seat belt buckle, an adjustable slider is available on the belt to help position the buckle when not in use.

## Tensioning the safety belt automatically

When the belt is closed, it is automatically tightened once after the release.

## Unbuckling the belt

1. Hold the belt firmly.
2. Press the red button in the belt buckle.
3. Guide the belt back into its reel.

## Safety belt reminder for driver's and passenger's seat



The indicator lamp lights up and a signal sounds. Make sure that the safety belts are positioned correctly. The safety belt reminder is active at speeds above approx. 6 mph/10 km/h. It can also be activated if objects are placed on the front passenger seat.

## Damage to safety belts

In the case of strain caused by accidents or damage:

Have the safety belts, including the safety belt tensioners, replaced and have the belt anchors checked.





Checking and replacing safety belts

Have the work performed only by your service center; otherwise, it cannot be ensured that this safety feature will function properly. ◀

## Front head restraints

### Correctly adjusted head restraint

A correctly adjusted head restraint reduces the risk of injury to cervical vertebrae in the event of an accident.



Adjusting the head restraint

Correctly adjust the head restraints of all occupied seats; otherwise, there is an increased risk of injury in an accident. ◀

### Height

Adjust the head restraint so that its center is approximately at ear level.

### Distance

Adjust the distance so that the head restraint is as close as possible to the back of the head.

### Active head restraint

In the event of a rear-end collision with a certain severity, the active head restraint automatically reduces the distance from the head.



Reduced protective function

- ▶ Do not use seat or head restraint covers.
- ▶ Do not hang objects, e.g., clothes hangers, on the head restraints.
- ▶ Only attach accessories approved by BMW to the seat or head restraint.

Otherwise, the protective function of the active head restraint will be impaired and the personal safety of the occupants will be endangered. ◀

In the case of strain caused by accidents or damage:

Have the active headrest checked and if necessary replaced.

### Adjusting the height: manual head restraints

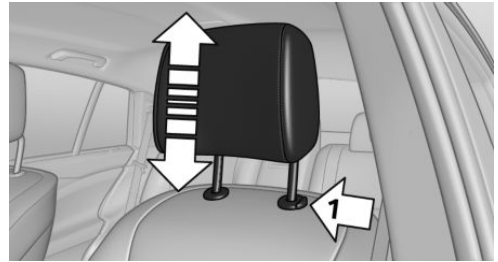

- ▶ To raise: pull.
- ▶ To lower: press the button, arrow 1, and push the head restraint down.

### Adjusting the height: electrical head restraints

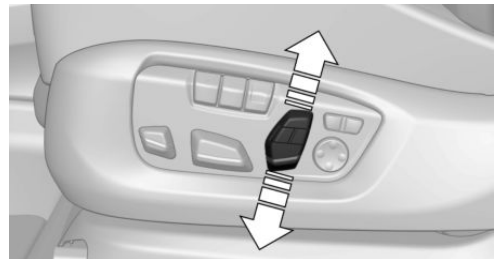

Adjusting electrically.

## Distance to back of head: manual head restraints

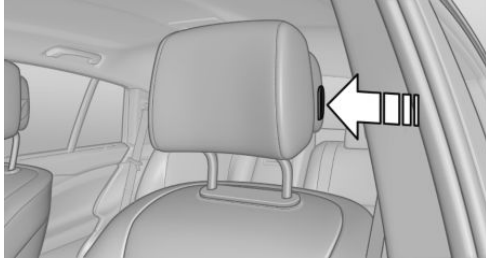

- ▷ Forward: by pulling
- ▷ Back: press the button and push the head restraint toward the rear.

## Distance to back of head: electrical head restraints

The head restraint is automatically repositioned when the shoulder support is adjusted.

## Adjusting the side extensions

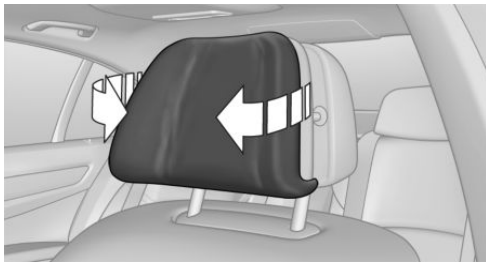

Fold forward for increased lateral support in the resting position.

## Removing

The head restraints cannot be removed.

## Rear head restraints

### Correctly adjusted head restraint

A correctly adjusted head restraint reduces the risk of injury to cervical vertebrae in the event of an accident.



Adjusting the head restraint

Correctly adjust the head restraints of all occupied seats; otherwise, there is an increased risk of injury in an accident. ◀

## Height

Adjust the head restraint so that its center is approximately at ear level.

## Adjusting the height

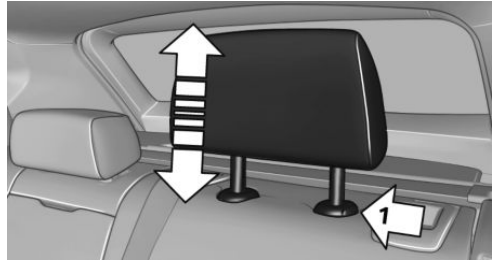

- ▷ To raise: pull.
- ▷ To lower: press the button, arrow 1, and push the head restraint down.

The center head restraint cannot be adjusted in elevation.

## Removing

Only remove the head restraint if no one will be sitting in the seat in question.

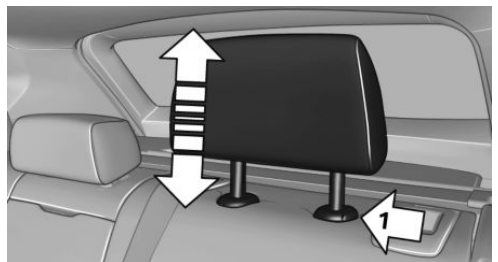



1. Pull the head restraint upward as far as possible.
2. Press the button, arrow 1, and pull the head restraint out completely.

-  Before transporting passengers  
Reinstall the head restraint before transporting anyone in the seat; otherwise, the protective function of the head restraint is unavailable. ◀

## Seat, mirror, and steering wheel memory

### Hints

-  Do not retrieve the memory while driving  
Do not retrieve the memory setting while driving, as an unexpected movement of the seat or steering wheel could result in an accident. ◀
-  Keep the movement area unobstructed  
When changing the seat position, keep the seat's area of movement unobstructed; otherwise, people can be injured or objects damaged. ◀

### General information



Two different driver's seat, exterior mirror, and steering wheel positions can be stored and retrieved for each remote control. The adjustment of the lumbar support is not stored.

### Storing

1. Switch on the ignition.
2. Set the desired position.

3.  Press the button. The LED in the button lights up.
4. Press the desired button 1 or 2. The LED goes out.

If the M button is pressed accidentally:

-  Press the button again.  
The LED goes out.

### Calling up settings

#### Comfort function

1. Open the driver's door.
2. Switch off the ignition.
3. Briefly press the desired button 1 or 2.

The corresponding seat position is performed automatically.

The procedure stops when a switch for adjusting the seat or one of the buttons is pressed.

#### Safety mode

1. Close the driver's door or switch on the ignition.
2. Press and hold the desired button 1 or 2 until the adjustment procedure is completed.

#### Calling up of a seat position deactivated

After a brief period, the calling up of stored seat positions is deactivated to save battery power.

To reactivate calling up of a seat position:

- ▶ Open or close the door or tailgate.
- ▶ Press a button on the remote control.
- ▶ Press the Start/Stop button.

## Mirrors

### Exterior mirrors

#### At a glance



- 1 Adjusting
- 2 Left/right, Automatic Curb Monitor
- 3 Fold in and out

#### General information

The mirror on the passenger side is more curved than the driver's side mirror.

#### Estimating distances correctly

Objects reflected in the mirror are closer than they appear. Do not estimate the distance to the traffic behind you based on what you see in the mirror, as this will increase your risk of an accident. ◀

Depending on how the vehicle is equipped, the mirror setting is stored for the remote control in use. When the vehicle is unlocked via the remote control, the position is automatically retrieved if the setting for this function is active.

#### Selecting a mirror



To change over to the other mirror:  
Slide the mirror changeover switch.

#### Adjusting electrically



The setting corresponds to the direction in which the button is pressed.

#### Saving positions

Seat, mirror, and steering wheel memory, refer to page 59.

#### Adjusting manually

If an electrical malfunction occurs, for example, press the edges of the mirror glass.

#### Automatic Curb Monitor

##### The concept

When the reverse gear is engaged, the mirror glass tilts downward slightly on the front passenger side. This improves your view of the curb and other low-lying obstacles when parking, for example.

##### Activating



1. Slide the mirror changeover switch to the driver's side mirror position.
2. Engage transmission position R.

##### Deactivating

Slide the mirror changeover switch to the passenger side mirror position.

##### Fold in and out



Press the button.

Possible up to approx. 15 mph/20 km/h.

For example, this is advantageous

- ▷ In car washes.
- ▷ In narrow streets.
- ▷ For folding back mirrors that were folded away manually.

Mirrors that were folded in are folded out automatically at a speed of approx. 25 mph/40 km/h.



Fold in the mirror in a car wash

Before washing the car in an automatic car wash, fold in the exterior mirrors by hand or with the button; otherwise, the mirrors could be damaged, depending on the width of the vehicle. ◀

### Automatic heating

Both exterior mirrors are automatically heated whenever the engine is running.

### Automatic dimming feature

Both exterior mirrors are automatically dimmed. Photocells are used for control in the Interior rear view mirror, refer to page 61.

### Interior rearview mirror, automatic dimming feature

#### The concept

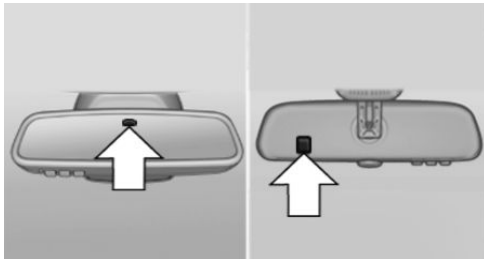

Photocells are used for control:

- ▶ In the mirror glass.
- ▶ On the back of the mirror.

#### Functional requirement

For proper operation:

- ▶ Keep the photocells clean.
- ▶ Do not cover the area between the inside rearview mirror and the windshield.

## Steering wheel

### General information



Do not adjust while driving

Do not adjust the steering wheel while driving; otherwise, an unexpected movement could result in an accident. ◀

### Manual steering wheel adjustment

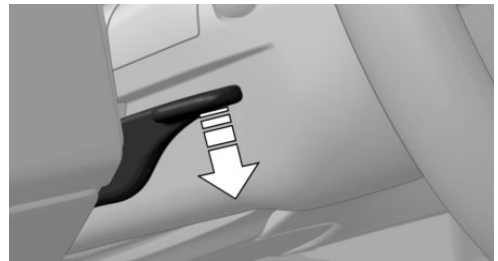

1. Fold the lever down.
2. Move the steering wheel to the preferred height and angle to suit your seating position.
3. Fold the lever back.

### Power steering wheel adjustment

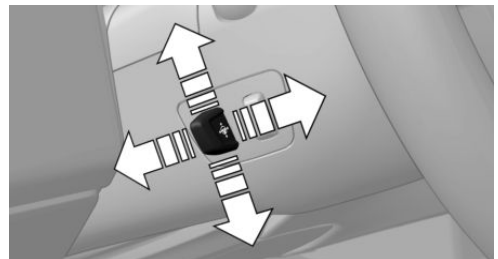

The steering wheel can be adjusted in four directions.

### Storing the position

Seat, mirror and steering wheel memory, refer to page 59.

## Steering wheel heating



### Switching on/off



Press the button.

- ▷ On: the LED lights up.
- ▷ Off: the LED goes out.

# Transporting children safely

## Vehicle equipment

All standard, country-specific and optional equipment that is offered in the model series is described in this chapter. Therefore, equipment is also described that is not available in a vehicle, e. g., because of the selected optional equipment or country variant. This also applies for safety-related functions and systems.

## The right place for children

### Note



Children in the vehicle

Do not leave children unattended in the vehicle; otherwise, they could endanger themselves and other persons, e.g., by opening the doors. ◀

### Children should always be in the rear

Accident research shows that the safest place for children is in the back seat.



Transporting children in the rear

Only transport children younger than 13 years of age or shorter than 5 ft/150 cm in the rear in child restraint fixing systems provided in accordance with the age, weight and size of the child; otherwise, there is an increased risk of injury in an accident.

Children 13 years of age or older must wear a safety belt as soon as a suitable child restraint fixing system can no longer be used, due to their age, weight and size. ◀

### Children on the front passenger seat

Should it ever be necessary to use a child restraint fixing system in the front passenger seat, make sure that the front, knee and side airbags on the front passenger side are deacti-

vated. Automatic deactivation of front passenger airbags, refer to page 106.

### Note



Deactivated front passenger airbags

If a child restraint fixing system is used in the front passenger seat, the front passenger airbags must be deactivated; otherwise, there is an increased risk of injury to the child when the airbags are triggered, even with a child restraint fixing system. ◀

## Installing child restraint fixing systems

### Before mounting

Before mounting child restraint fixing systems, ensure that the rear seat backrests are locked.

### Third row of seats

Before installing a child restraint system on the third row of seats, note the following:

- ▷ Roll up the cargo cover, partition net and remove the case
- ▷ Bring seats and backrests of the second row of seats into the forwardmost position
- ▷ Raise the headrests of the third row of seats into the highest position.

Do not change the settings that have been made after this.

### Hints



Manufacturer's information for child restraint fixing systems

To select, mount and use child restraint fixing systems, observe the information provided by the system manufacturer; otherwise, the protective effect can be impaired. ◀



Lock the rear seat backrests in position

Before installation of child restraint systems on the rear seat backrest, set a backrest tilt at which the childseat rests firmly against the backrest and securely latch all backrests. Otherwise, the stability of the child seat is limited, and there is an increased risk of injury because of unexpected movement of the rear seat backrest. ◀



Lock seats of the second row of seats

When equipped with a third row of seats: when a child restraint system is installed on the second row of seats, make sure that this seat is correctly locked; otherwise, there is an increased risk of injury for the child in the event of an accident. ◀



Only approved child restraint systems on the third row of seats

On the third row of seats install only approved child restraint systems; otherwise the protective effect is not guaranteed and there is an increased risk of injury for the child in the event of an accident. ◀

## On the front passenger seat

### Deactivating airbags

After installing a child restraint fixing system in the front passenger seat, make sure that the front, knee and side airbags on the front passenger side are deactivated.

Deactivate the front passenger airbags automatically, refer to page 106.



Deactivating the front passenger airbags

If a child restraint fixing system is used in the front passenger seat, the front passenger airbags must be deactivated; otherwise, there is an increased risk of injury to the child when the airbags are triggered, even with a child restraint fixing system. ◀

## Seat position and height

Before installing a child restraint fixing system, move the front passenger seat as far back as possible and adjust its height to the highest position to obtain the best possible position for the belt and to offer optimal protection in the event of an accident.

Do not change the seat position and height after this.

## Backrest width

Adjustable backrest width: before installing a child restraint fixing system in the front passenger seat, open the backrest width completely. Do not change the backrest width again and do not call up a memory position.



Backrest width for the child seat

Before installing a child restraint fixing system in the front passenger seat, the backrest width must be opened completely. Do not change the adjustment after this; otherwise, the stability of the child seat will be reduced. ◀

## Child seat security



The rear safety belts and the front passenger safety belt can be locked against pulling out for mounting the child restraint fixing systems.

## Locking the safety belt

1. Pull out the belt webbing completely.
2. Secure the child restraint fixing system with the belt.



3. Allow the belt webbing to be pulled in and pull it taut against the child restraint fixing system. The safety belt is locked.

### Unlocking the safety belt

1. Unbuckle the belt buckle.
2. Remove the child restraint fixing system.
3. Allow the belt webbing to be pulled in completely.

## LATCH child restraint fixing system

LATCH: Lower Anchors and Tether for Children.

### Note

 Manufacturer's information for LATCH child restraint fixing systems

To mount and use the LATCH child restraint fixing systems, observe the operating and safety information from the system manufacturer; otherwise, the level of protection may be reduced. ◀

### Mounts for the lower LATCH anchors

The lower anchors may be used to attach the CRS to the vehicle seat up to a combined child and CRS weight of 65 lb/30 kg when the child is restrained by the internal harnesses.

 Correctly engage the lower LATCH anchors

Make sure that the lower LATCH anchors have properly engaged and that the child restraint fixing system is resting snugly against the backrest; otherwise, the degree of protection offered may be reduced. ◀

Before mounting the LATCH child restraint fixing system, pull the belt away from the child restraint fixing system.

### Position

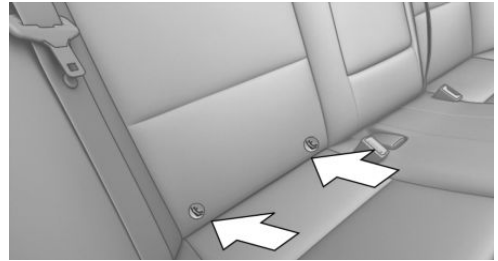

Mounts for the lower LATCH anchors are located in the gap between the seat and backrest.

### Mounting ISOFIX child restraint fixing systems

1. Mount the child restraint fixing system; refer to the user's manual of the system.
2. Ensure that both LATCH anchors are properly connected.

### Child restraint fixing system with a tether strap

### Mounting points

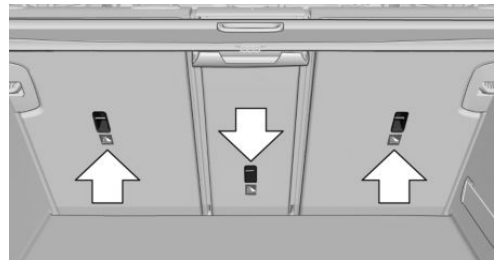

There are three mounting points for the upper retaining strap of LATCH child restraint fixing systems.

**Note****Mounting eyes**

Only use the mounting eyes for the upper retaining strap to secure child restraint fixing systems; otherwise, the mounting eyes could be damaged. ◀

**Retaining strap guide****Retaining strap**

Make sure that the upper retaining strap is not routed over the head restraints or sharp edges and is free of twisting on its way to the upper mounting point; otherwise, the belt cannot properly secure the child restraint fixing system in an accident. ◀

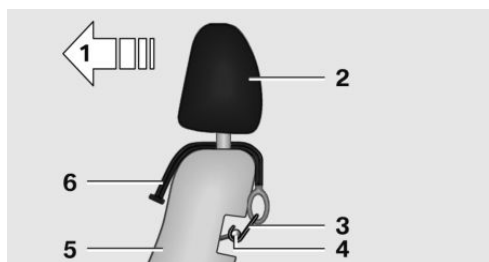

- 1 Direction of travel
- 2 Head restraint.
- 3 Hook for upper retaining strap
- 4 Mounting point/eye
- 5 Seat backrest
- 6 Upper retaining strap

**Attaching the upper retaining strap to the mounting point**

1. Raise the head restraint if necessary.
2. Guide the upper retaining strap between the supports of the head restraint.
3. If there is a retaining strap, run it between the backrest and the cargo cover.
4. Attach the hooks of the retaining strap to the mounting eyes.

5. Tighten the retaining strap by pulling it down.
6. Lower and lock head restraints as needed.

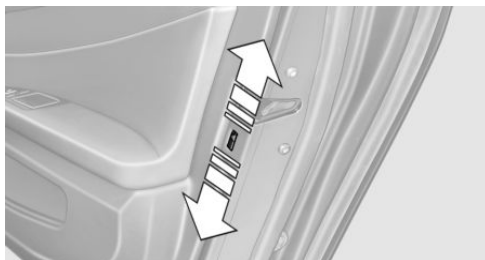
**Locking the doors and windows****Rear doors**

Push the locking lever on the rear doors up.

The door can now be opened from the outside only.

**Safety switch for the rear**

Press the button on the driver's door if children are being transported in the rear.

This locks various functions so that they cannot be operated from the rear: safety switch, refer to page 47.

# Driving

## Vehicle equipment

All standard, country-specific and optional equipment that is offered in the model series is described in this chapter. Therefore, equipment is also described that is not available in a vehicle, e. g., because of the selected optional equipment or country variant. This also applies for safety-related functions and systems.

## Start/Stop button

### The concept



Pressing the Start/Stop button switches the ignition on or off and starts the engine.

The engine starts if the brake pedal is pressed when you press the Start/Stop button.

### Ignition on

Press the Start/Stop button, and do not press on the brake pedal at the same time.

All vehicle systems are ready for operation.

Most of the indicator and warning lamps in the instrument cluster light up for varying lengths of time.

To save battery power when the engine is off, switch off the ignition and any unnecessary electronic systems/power consumers.

### Note

If the engine is switched off and the ignition is switched on, the system automatically switches to the radio ready state when the door is opened if the lights are switched off or the daytime running lights are switched on.

### Ignition off

Press the Start/Stop button again, and do not press on the brake pedal at the same time.

All indicator lamps in the instrument cluster go out.

To save battery power when the engine is off, switch off the ignition and any unnecessary electronic systems/power consumers.



Transmission position P with the ignition off

When ignition is switched off, selector lever position P is engaged automatically. When in an automatic car wash, for example, ensure that the ignition is not switched off accidentally. ◀

The ignition automatically cuts off while the vehicle is stationary and the engine is stopped:

- ▷ When locking the vehicle, and when the low beams are activated.
- ▷ Shortly before the battery is discharged completely, so that the engine can still be started. This function is only available when the low beams are switched off.
- ▷ When opening or closing the driver door, if the driver's seat belt is unbuckled and the low beams are switched off.
- ▷ While the driver's seat belt is unbuckled, if the driver's door is open and the low beams are switched off.

When the ignition is switched off, by opening or closing the driver's door or unbuckling the driver's seat belt, the radio ready state remains active.

### Radio ready state

Activate radio ready state:

- ▷ When the engine is running: press the Start/Stop button.

Some electronic systems/power consumers remain ready for operation.

The radio ready state switches off automatically:

- ▷ After approx. 8 minutes.
- ▷ When the vehicle is locked using the central locking system.
- ▷ Shortly before the battery is discharged completely, so that the engine can still be started.

## Starting the engine

### Hints



#### Enclosed areas

Do not let the engine run in enclosed areas, since breathing in exhaust fumes may lead to loss of consciousness and death. The exhaust gases contain carbon monoxide, an odorless and colorless, but highly toxic gas. ◀



#### Unattended vehicle

Do not leave the vehicle unattended with the engine running; doing so poses a risk of danger.

Before leaving the vehicle with the engine running, set the parking brake and place the transmission in selector lever position P or neutral to prevent the vehicle from moving. ◀



#### Repeated starting in quick succession

Avoid repeated unsuccessful attempts to start the vehicle or starting the vehicle several times in quick succession. Otherwise, the fuel is not burned or is inadequately burned, posing a risk of overheating and damage to the catalytic converter. ◀

Do not wait for the engine to warm-up while the vehicle remains stationary. Start driving at moderate engine speeds.

## Diesel engine

If the engine is cold and temperatures are below approx. 32 °F/0 °C, the start process may be delayed somewhat due to automatic pre-heating.

A Check Control message is displayed.

## Automatic transmission

### Starting the engine

1. Depress the brake pedal.
2. Press the Start/Stop button.

The ignition is activated automatically for a certain time and is stopped as soon as the engine starts.

## Engine stop

### Hints



Take the remote control with you

Take the remote control with you when leaving the vehicle so that children, for example, cannot start the engine. ◀



Set the parking brake and further secure the vehicle as required

Set the parking brake firmly when parking; otherwise, the vehicle could roll. On steep upward and downward inclines, further secure the vehicle, for example, by turning the steering wheel in the direction of the curb. ◀

## Before driving into a car wash

In order for the vehicle to be able to roll into a car wash, pay attention to the information regarding Washing in automatic car washes, refer to page 244. ◀

## Automatic transmission

### Switching off the engine

1. Engage transmission position P with the vehicle stopped.
2. Press the Start/Stop button.  
The engine is switched off.  
The radio ready state is switched on.
3. Set the parking brake.

## Automatic Engine Start/Stop Function

### The concept

The Auto Start/Stop function helps save fuel. The system switches off the engine during a stop, e.g., in traffic congestion or at traffic lights. The ignition remains switched on. The engine starts again automatically for driving off.

Certain vehicle components may experience additional wear as a result of this system.

### Automatic mode

The Auto Start/Stop function is operational after each engine start.

This function is activated at speeds faster than about 3 mph, approx. 5 km/h.

### Engine stop

The engine is switched off automatically during a stop under the following conditions:

Automatic transmission:

- ▶ The selector lever is in transmission position D.
- ▶ The brake pedal remains pressed while the vehicle is stationary or the vehicle is held by Automatic Hold.
- ▶ The driver's seat belt is buckled or the driver's door is closed.

The air volume of the air conditioner is reduced when the engine is switched off.

### Displays in the instrument cluster



The display indicates that the automatic engine start-stop function is ready for an automatic engine start.



The display indicates that the conditions for an automatic engine stop have not been satisfied.

### Note

The engine is not switched off automatically in the following situations:

- ▶ External temperature too low.
- ▶ The external temperature is high and automatic climate control is running.
- ▶ The passenger compartment has not yet been heated or cooled to the required level.
- ▶ The engine is not yet at operating temperature.
- ▶ The wheels are at a sharp angle or the steering wheel is being turned.
- ▶ After driving in reverse.
- ▶ Fogging of the windows when the automatic climate control is switched on.
- ▶ Vehicle battery is heavily discharged.
- ▶ The engine compartment lid is unlocked.
- ▶ HDC Hill Descent Control is activated.
- ▶ The parking assistant is activated.
- ▶ Stop-and-go traffic.
- ▶ The transmission selector lever is in position N or M/S.
- ▶ Use of fuel with high ethanol content.

## Starting the engine

The engine starts automatically under the following conditions:

- ▷ Automatic transmission:  
By releasing the brake pedal.  
When Automatic Hold is activated: press the accelerator.

After the engine starts, accelerate as usual.

## Safety mode

After the engine switches off automatically, it will not start again automatically if any one of the following conditions are met.

- ▷ The driver's safety belt is unbuckled and the driver's door is open.
- ▷ The hood was unlocked.

Some indicator lamps light up for varying lengths of time.

The engine can only be started via the Start/Stop button.

## Note

Even if driving away was not intended, the deactivated engine starts up automatically in the following situations:

- ▷ Excessive warming of the passenger compartment when the cooling function is switched on.
- ▷ The steering wheel is turned.
- ▷ Automatic transmission: the transmission position is changed from D to N, R, or M/S.
- ▷ Automatic transmission: the transmission position is changed from P to N, D, R or M/S.
- ▷ Fogging of the windows when the automatic climate control is switched on.
- ▷ Vehicle battery is heavily discharged.
- ▷ Excessive cooling of the passenger compartment when the heating is switched on.

## Preventing an automatic engine stop with automatic transmission

### The concept

To make it possible to drive away very quickly, such as at an intersection, the automatic engine stop can be actively prevented.

### Preventing an engine stop using the brake pedal

The engine stop can be actively prevented within one second after the vehicle comes to a standstill.

- ▷ Immediately after the vehicle comes to a standstill, briefly press the brake pedal forcefully.
- ▷ Then press the brake pedal with normal braking force.

## Activating/deactivating the system manually

### Using the button



 Press the button.

- ▷ LED comes on: Auto Start Stop function is deactivated.

The engine is started during an automatic engine stop.

The engine can only be stopped or started via the Start/Stop button.

- ▷ LED goes out: Auto Start Stop function is activated.

## Switching off the vehicle during an automatic engine stop

During an automatic engine stop, the vehicle can be switched off permanently, e.g., when leaving it.

1. Press the Start/Stop button. The ignition is switched off. The Auto Start/Stop function is deactivated.

Transmission position P is engaged automatically.

2. Set the parking brake.

Engine start as usual via Start/Stop button.

## Automatic deactivation

In certain situations, the Auto Start/Stop function is deactivated automatically for safety reasons, such as when the driver is detected to be absent.

## Malfunction

The Auto Start/Stop function no longer switches of the engine automatically. A Check Control message is displayed. It is possible to continue driving. Have the system checked.

## Parking brake

### The concept

The parking brake is used to prevent the vehicle from rolling when it is parked.



## Setting

-  Pull the switch.  
The LED lights up.

-  The indicator lamp lights up red. The parking brake is set.

-  Lower lamp: indicator lamp in Canadian models

-  Set the parking brake and further secure the vehicle as required

Set the parking brake firmly when parking; otherwise, the vehicle could roll. On steep upward and downward inclines, further secure the vehicle, for example, by turning the steering wheel in the direction of the curb. ◀

## While driving

Use while driving serves as an emergency braking function:

Pull the switch and hold it. The vehicle brakes hard while the switch is being pulled.

-  The indicator lamp lights up red, a signal sounds and the brake lamps light up.

-  Lower lamp: indicator lamp in Canadian models.

If the vehicle is braked down to a speed of approx. 2 mph/3 km/h the parking brake is set.

## Releasing

With the ignition switched on:

-  Automatic transmission: Press the switch while the brake is pressed or transmission position P is engaged.

The LED and indicator lamp go out.

The parking brake is released.

## Automatic Release in cars with automatic transmission

For automatic release, operate the accelerator pedal.

The LED and indicator lamp go out.

Subject to the following requirements, the parking brake is automatically released by operation of the accelerator pedal:

- ▷ Engine on.
- ▷ Drive mode engaged.
- ▷ Driver buckled in and doors closed.

 Inadvertent operation of the accelerator pedal

Make sure that the accelerator pedal is not operated unintentionally; otherwise, the vehicle is set in motion and there is a risk of an accident. ◀

## Automatic Hold

### The concept

This system assists the driver by automatically setting and releasing the brake, such as when moving in stop-and-go traffic.

The vehicle is automatically held in place when it is stationary.

On inclines, the system prevents the vehicle from rolling backward when driving away.





### For your safety

Under the following conditions, Automatic Hold is automatically deactivated and the parking brake is set:

- ▷ The engine is switched off.
- ▷ A door is opened and driver's safety belt is unbuckled while the vehicle is stationary.
- ▷ The moving vehicle is brought to a standstill using the parking brake.

 The indicator lamp switches from green to red and the letters AUTO H go out.

 Lower lamp: indicator lamp in Canadian models.

 Leaving the vehicle with the engine running

Before leaving the vehicle with the engine running, engage position P of the automatic transmission and ensure that the parking brake is set. Otherwise, the vehicle may begin to roll. ◀

## Activating

This function can be activated when the driver's door is closed and the safety belt is fastened, and while driving.

 Press the button.  
The LED and the letters AUTO H light up.

 The indicator lamp lights up.  
Automatic Hold is activated.

## Deactivating

 Press the button again.  
The LED and the letters AUTO H go out.

Automatic Hold is deactivated.



If the vehicle is being held by Automatic Hold, press on the brake pedal to deactivate it.

When the parking brake is set manually, Automatic Hold is deactivated automatically.



## Driving

Automatic Hold is activated: the vehicle is automatically secured against rolling after braking to a standstill.



-  The indicator lamp lights up green.  
Step on the accelerator pedal to drive off.
-  The brake is released automatically.  
The indicator lamp goes out.

Lower lamp: indicator lamp in Canadian models

-  Before driving into a car wash  
Before driving into the car wash, deactivate Automatic Hold; otherwise, the parking brake will be set when the vehicle is stationary and the vehicle will no longer be able to roll. ◀

## Parking

The parking brake is automatically set if the engine is switched off while the vehicle is being held by Automatic Hold.

-  The indicator lamp changes from green to red.
-  The parking brake is not set if the engine is switched off while the vehicle is coasting to a halt. Automatic Hold is deactivated.

Lower lamp: indicator lamp in Canadian models

Automatic Hold remains activated during the engine stop brought about by the Auto Start/Stop function.

-  Take the remote control with you  
Take the remote control with you when leaving the vehicle so that children, for example, cannot release the parking brake. ◀

## Malfunction

In the event of a failure or malfunction of the parking brake, secure the vehicle against roll-

ing using a wheel chock, for example, when leaving it.

## Manual release

The parking brake can be released manually in the event of a power failure or electrical fault.

-  Before releasing, secure the vehicle against rolling

Before releasing the parking brake manually, and whenever you park the vehicle with the parking brake released, ensure that position P of the automatic transmission is engaged.

Secure the vehicle in a manner appropriate to the inclination of the road, e.g., with a wheel chock; otherwise, there is the danger of an accident and injuries if the vehicle rolls unintentionally. ◀

## Unlocking

1. Open the left side trim in the cargo area.
2. Remove the first aid kit and warning triangle. Close the bracket of the warning triangle.
3. Insert the screwdriver, in the onboard vehicle tool kit under the cargo floor panel, into the strap of the release point, see arrow.
4. Forcefully pull the screwdriver up against the mechanical resistance until you notice a marked increase in the resistance and the parking brake releases audibly.

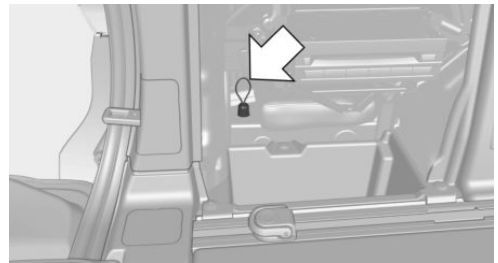

5. Stow the screwdriver, warning triangle and first aid kit, and close the left side trim in the cargo area.



Have the malfunction corrected

If the parking brake has been released manually in response to a malfunction, only technicians can return it to operation.

Have the malfunction corrected by your service center. ◀

### After a power failure



Only put the parking brake into operation after a power failure

The parking brake should only be put into operation again if it was manually released due to an interruption in the supply of electrical power. Otherwise, it cannot be ensured that the parking brake will function properly. ◀

### Putting the parking brake into operation

1. Switch on the ignition.



2. Press the switch while the brake is depressed or transmission position P is engaged.

It may take several seconds for the brake to be put into operation. Any sounds associated with this are normal.



The indicator lamp in the instrument cluster goes out as soon as the parking brake is ready for operation.



Lower lamp: indicator lamp in Canadian models.

## Turn signal, high beams, headlamp flasher

### Turn signal



Do not fold in the exterior mirrors

Do not fold in the exterior mirror while driving and when the turn signals/warning flashers are working, or else the additional flasher lights in the exterior mirror will no lon-

ger be in the prescribed position and will be difficult to see. ◀

### Using turn signals

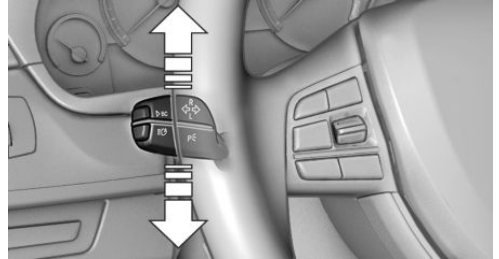

Press the lever beyond the resistance point. To switch off manually, press the lever to the resistance point.

Unusually rapid flashing of the indicator lamp indicates that a turn signal bulb has failed.

### Triple turn signal activation

Press the lever to the resistance point.

The turn signal flashes three times.

The function can be activated or deactivated:

1. "Settings"
2. "Lighting"
3. "Triple turn signal"

### Signaling briefly

Press the lever to the resistance point and hold it there for as long as you want the turn signal to flash.

## High beams, headlamp flasher

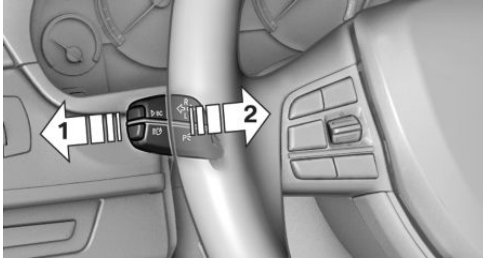

- ▷ High beams, arrow 1.
- ▷ Headlamp flasher, arrow 2.

## Washer/wiper system

### Switching the wipers on/off and brief wipe

**!** Do not switch on the wipers if frozen  
Do not switch on the wipers if they are frozen onto the windshield; otherwise, the wiper blades and the windshield wiper motor may be damaged. ◀

**!** No wiper operation on dry windshield  
Do not use the windshield wipers if the windshield is dry, as this may damage the wiper blades or cause them to become worn more quickly. ◀

### Switching on

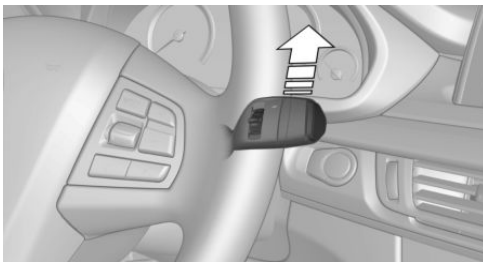

Press the wiper levers up.

The lever automatically returns to its initial position when released.

- ▷ Normal wiping speed: press up once.  
The wipers switch to intermittent operation when the vehicle is stationary.
- ▷ Fast wiping speed: press up twice or press once beyond the resistance point.  
The wipers switch to normal speed when the vehicle is stationary.

### Switching off and brief wipe

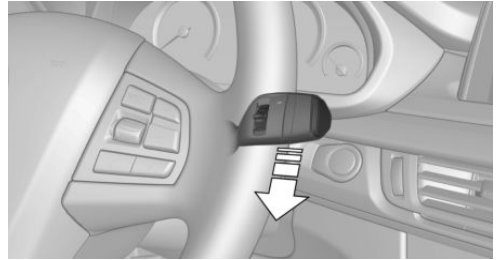

Press the wiper levers down.

The lever automatically returns to its initial position when released.

- ▷ Brief wipe: press down once.
- ▷ To switch off normal wipe: press down once.
- ▷ To switch off fast wipe: press down twice.

## Rain sensor

### The concept

The rain sensor automatically controls the time between wipes depending on the intensity of the rainfall. The sensor is located on the windshield, directly behind the interior rearview mirror.

## Activating/deactivating

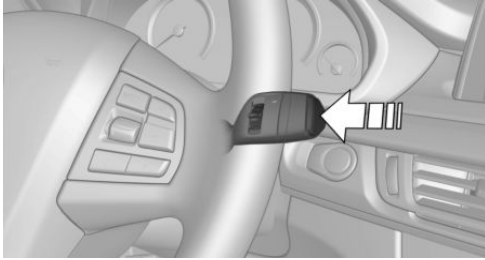

Press the button on the wiper lever.

The LED in the wiper lever lights up and a wiping operation is started. If there is frost, wiper operation is not started.



Deactivate the rain sensor in car washes  
Deactivate the rain sensor when passing through an automatic car wash; otherwise, damage could be caused by undesired wiper activation. ◀

## Rain sensor, sensitivity

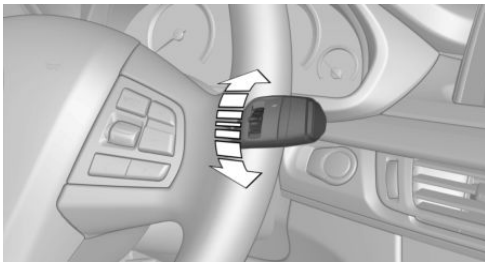

Turn the thumbwheel.

## Clean the windshield, headlamps

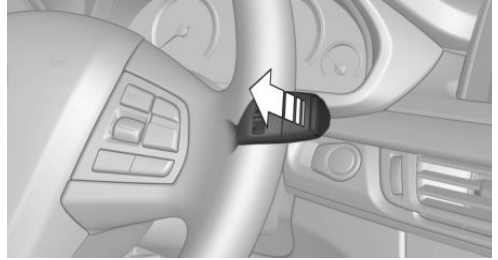

Pull the wiper lever.

The system sprays washer fluid on the windshield and activates the wipers briefly.

In addition, the headlamps are cleaned at regular intervals when the vehicle lights are switched on.



Do not use the washer system at freezing temperatures

Do not use the washers if there is any danger that the fluid will freeze on the windshield; otherwise, your vision could be obscured. For this reason, use antifreeze.

Avoid using the washer when the reservoir is empty; otherwise, you could damage the pump. ◀

## Windshield washer nozzles

The windshield washer nozzles are automatically heated while the ignition is switched on.

## Rear window wiper

### Switching on the rear window wiper

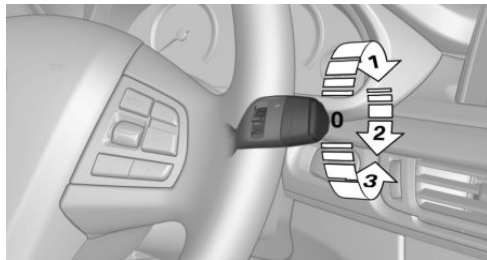

Turn switch from idle position 0 upward, arrow 1: interval mode. When reverse gear is engaged, the system switches to continuous operation.

### Cleaning rear window

In interval mode: turn the switch further, arrow 2. The switch automatically returns to its interval position when released.

In idle position: turn switch downward, arrow 3. The switch automatically returns to its idle position when released.

### Fold-out position of the wipers

Required when changing the wiper blades or under frosty conditions, for example.

1. Switch the ignition on and off again.
2. Under frosty conditions, ensure that the wiper blades are not frozen onto the windshield.
3. Press the wiper lever up beyond the point of resistance and hold it for approx. 3 seconds, until the wiper remains in a nearly vertical position.

After the wipers are folded back down, the wiper system must be reactivated.



Fold the wipers back down

Before switching the ignition on, fold the wipers back down to the windshield; otherwise, the wipers may become damaged when they are switched on. ◀

1. Switch on the ignition.
2. Press the wiper levers down. The wipers move to their resting position and are ready for operation.

## Washer fluid

### General information



Antifreeze for washer fluid

Antifreeze is flammable and can cause injury if it is used incorrectly.

Therefore, keep it away from sources of ignition.

Only keep it in the closed original container and inaccessible to children.

Follow the notes and instructions on the container.

United States: The washer fluid mixture ratio is regulated by the U.S. EPA and many individual states; do not exceed the allowable washer fluid dilution ratios limits that apply. Follow the usage instructions on the washer fluid container. Use BMW's Windshield Washer Concentrate or the equivalent. ◀

### Washer fluid reservoir



Adding washer fluid

Only add washer fluid when the engine is cool, and then close the cover completely to avoid contact between the washer fluid and hot engine parts.

Otherwise, there is the danger of fire and a risk to personal safety if the fluid is spilled. ◀

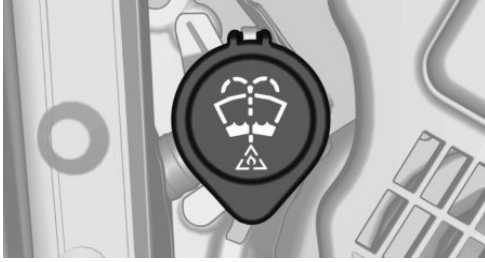

All washer nozzles are supplied from one reservoir.

Fill with a mixture of windshield washer concentrate and tap water and – if required – with a washer antifreeze, according to the manufacturer's recommendations.

Mix the washer fluid before adding to maintain the correct mixing ratio.

Do not add windshield washer concentrate and antifreeze undiluted and do not fill with pure water; this could damage the wiper system.

Do not mix window washer concentrates of different manufacturers, because otherwise it can result in clogging of the windshield washer nozzles.

Recommended minimum fill quantity: 0.2 US gal/1 liter.

## Automatic transmission with Steptronic

### Transmission positions

#### D Drive, automatic position

Position for normal vehicle operation. All forward gears are available.

#### R is Reverse

Select only when the vehicle is stationary.

#### N is Neutral

Use in automatic car washes, for example. The vehicle can roll.

When the ignition is switched off, refer to page 67, position P is engaged automatically.

### P Park

Select only when the vehicle is stationary. The drive wheels are blocked.

P is engaged automatically:

- ▷ After the engine is switched off when the vehicle is in radio ready state, refer to page 67, or when the ignition is switched off, refer to page 67, and when position R or D is engaged.
- ▷ With the ignition is off, if position N is engaged.
- ▷ If the safety belt is unbuckled, the driver's door is opened, and the brake pedal is not pressed while the vehicle is stationary and transmission position R or D is engaged.

Before exiting the vehicle, make sure that position P of the automatic transmission is engaged. Otherwise, the vehicle may begin to roll.

### Kickdown

Kickdown is used to achieve maximum driving performance. Press on the gas pedal beyond the resistance point at the full throttle position.

### Engaging the transmission position

- ▷ Transmission position P can only be disengaged if the engine is running and the brake pedal is pressed.
- ▷ With the vehicle stationary, press on the brake pedal before shifting out of P or N; otherwise, the shift command will not be executed: shift lock.



Depress the brake until you start driving

To prevent the vehicle from creeping after you select a driving position, maintain pressure on the brake pedal until you are ready to start. ◀

## Engaging D, R and N

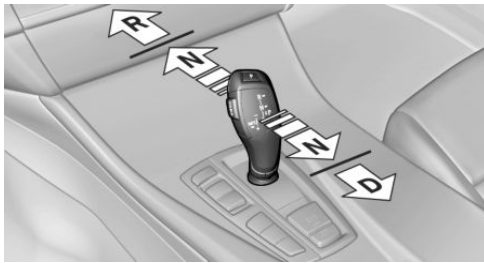

Briefly push the selector lever in the desired direction, beyond a resistance point if necessary. After releasing the selector lever, it returns to its center position.



Press unlock button, in order to:

- ▶ Engage R.
- ▶ Shift out of P.

## Engaging P



Press button P.

## Sport program and manual mode

### Activating the sport program



Push the selector lever to the left out of transmission position D.

The engaged gear is displayed in the instrument cluster, e.g., S1.

The sport program of the transmission is activated.

### Activating the M/S manual mode

1. Push the selector lever to the left out of transmission position D.
2. Push the selector lever forward or pull it backward.

Manual mode becomes active and the gear is changed.

The engaged gear is displayed in the instrument cluster, e.g., M1.

Once maximum engine speed is attained, M/S manual mode is automatically upshifted as needed.

### Switching to manual mode

- ▶ To shift down: press the selector lever forward.
- ▶ To shift up: pull the selector lever rearwards.

Gears will only be shifted at appropriate engine and road speeds, e.g., downshifting is not possible if the engine speed is too high.

The selected gear is briefly displayed in the instrument cluster, followed by the current gear.

## Not X5 M50d: Sport automatic transmission: prevent automatic upshifting in M/S manual mode

For vehicles with Sport automatic transmissions, automatic shift operations are not performed, at maximum engine speed for example, if one of the following conditions is met:

- ▷ DSC deactivated.
- ▷ TRACTION activated.
- ▷ SPORT+ activated.

In addition, the kickdown is deactivated.

## Ending the sport program/manual mode

Push the selector lever to the right.

D is displayed in the instrument cluster.

## Shift paddles



The shift paddles on the steering wheel allow you to shift gears quickly while keeping both hands on the steering wheel.

If the shift paddles on the steering wheel are used to shift gears in automatic mode, the transmission temporarily switches to manual mode.

If the shift paddles are not used and the vehicle is not accelerated for a certain time, the system switches back into automatic mode if the selector lever is in transmission position D.

- ▷ Shift up: pull right shift paddle.
- ▷ Shift down: pull left shift paddle.

Gears will only be shifted at appropriate engine and road speeds, e.g., downshifting is not possible if the engine speed is too high.

The selected gear is briefly displayed in the instrument cluster, followed by the current gear.

## Displays in the instrument cluster



The transmission position is displayed, e.g.: P.

## Sport automatic transmission: Launch Control

### The concept

Launch Control enables optimum acceleration on surfaces with good traction.

### Hints



Component wear

Do not use Launch Control too often; otherwise, this may result in premature wear of components due to the high stress placed on the vehicle. ◀

Did not use Launch Control during the break-in, refer to page 190, period.

To increase vehicle stability, activate DSC again as soon as possible.

### Requirements

Launch Control is available when the engine is warmed up, that is, after uninterrupted driving of at least 6 miles/10 km.

To start with Launch Control do not steer the steering wheel.

### Start with launch control

While the engine is running:

1.  Press button or select with the Driving Dynamics Control Sport+.



TRACTION is displayed in the instrument cluster and the indicator lamp for DSC OFF lights up.

2. Engaging the transmission position S
3. With the left foot, forcefully press down on the brake.
4. Press and hold down the accelerator pedal beyond the resistance point at the full throttle position.

A flag symbol appears in the instrument cluster.

5. The starting engine speed adjusts. Within 3 seconds, release the brake.

Before using Launch Control, allow the transmission to cool down for approx. 5 minutes.

Launch Control adjusts to the surrounding conditions, e.g., wet pavement, when used again.

# Displays

## Vehicle equipment

All standard, country-specific and optional equipment that is offered in the model series is described in this chapter. Therefore, equip-

ment is also described that is not available in a vehicle, e. g., because of the selected optional equipment or country variant. This also applies for safety-related functions and systems.

## Instrument cluster

### Overview, instrument cluster

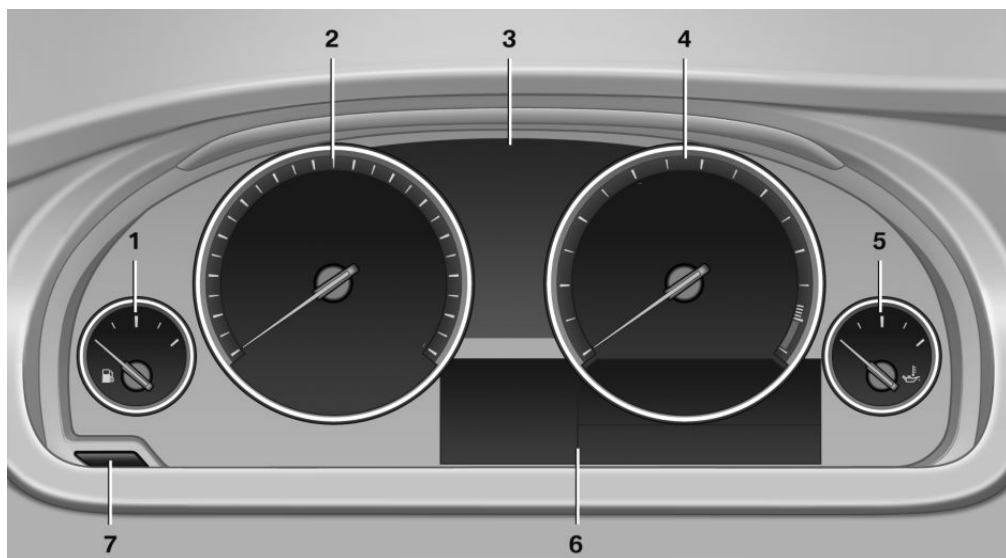

1 Fuel gauge [88](#)

2 Speedometer

3 Indicator/warning lamps [86](#)

4 Tachometer [88](#)

5 Engine oil temperature [88](#)

6 Electronic displays [84](#)

7 Display/reset miles [89](#)

## Overview, instrument cluster with enhanced features

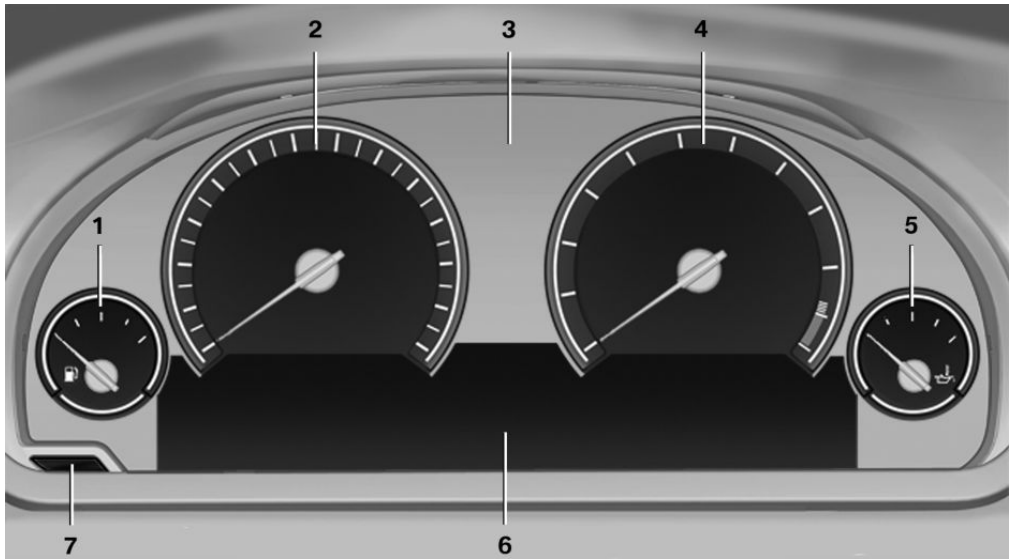

- |  |   |
|--|---|
| 1 Fuel gauge <a href="#">88</a>              | 5 Engine oil temperature <a href="#">88</a> |
| 2 Speedometer                                | 6 Electronic displays <a href="#">84</a>    |
| 3 Indicator/warning lamps <a href="#">86</a> | 7 Display/reset miles <a href="#">89</a>    |
| 4 Tachometer <a href="#">88</a>              |   |

## Electronic displays

### Overview, instrument cluster

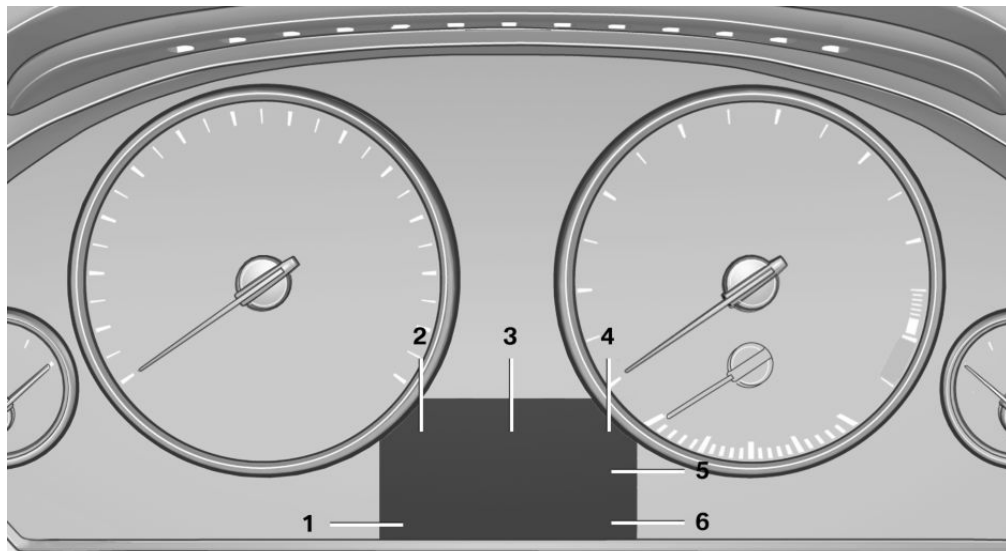

- |   |   |   |  |
|---|---|---|--|
| 1 | Clock <a href="#">89</a><br>External temperature <a href="#">89</a> | 5 | Computer <a href="#">93</a><br>Service requirements <a href="#">90</a>                 |
| 2 | Messages, e.g., Check Control <a href="#">86</a>                    | 6 | Kilometer display <a href="#">89</a><br>Selection list, e.g., radio <a href="#">93</a> |
| 3 | Transmission displays <a href="#">80</a>                            |   |  |
| 4 | Selection list, e.g., Driving Dynamics Control <a href="#">135</a>  |   |  |

## Overview, instrument cluster with navigation system or TV

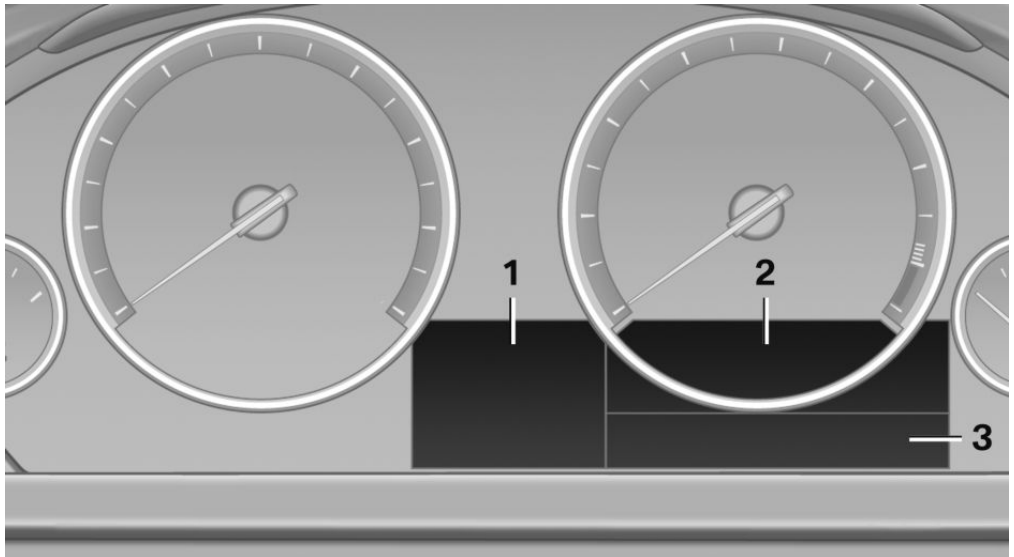

- |  |   |
|--|---|
| <p><b>1</b> Kilometer display <a href="#">89</a><br/>External temperature <a href="#">89</a><br/>Time <a href="#">89</a><br/>Selection list, e.g., radio <a href="#">93</a><br/>Navigation display, see user's manual for Navigation, Entertainment and Communication.<br/>Computer <a href="#">93</a></p> | <p>Symbol for service need</p> <p><b>2</b> Transmission display <a href="#">80</a><br/>Current fuel consumption <a href="#">90</a><br/>Energy recovery <a href="#">90</a></p> <p><b>3</b> Service requirements <a href="#">90</a><br/>Messages, e.g., Check Control <a href="#">86</a><br/>Navigation display, see user's manual for Navigation, Entertainment and Communication.</p> |
|--|---|

## Overview, instrument cluster with enhanced features

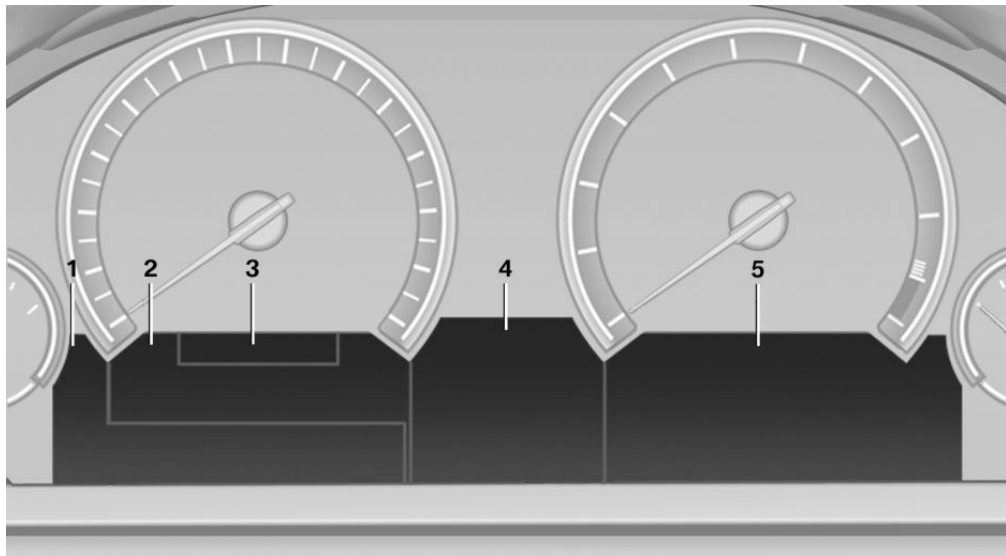

- |   |  |
|---|--|
| <p>1 Messages, e.g. Check Control <a href="#">86</a><br/>Time <a href="#">89</a></p> <p>2 Range <a href="#">89</a></p> <p>3 Computer <a href="#">93</a></p> <p>4 Navigation display, see user's manual for Navigation, Entertainment and Communication.<br/>Service requirements <a href="#">90</a></p> | <p>Kilometer display <a href="#">89</a></p> <p>5 Selection list, e.g., radio <a href="#">93</a><br/>Current fuel consumption <a href="#">90</a><br/>Energy recovery <a href="#">90</a><br/>External temperature <a href="#">89</a><br/>Transmission display <a href="#">80</a></p> |
|---|--|

## Check Control

### The concept

The Check Control system monitors functions in the vehicle and notifies you of malfunctions in the monitored systems.

A Check Control message is displayed as a combination of indicator or warning lamps and text messages in the instrument cluster and in the Head-up Display.















In addition, an acoustic signal may be output and a text message may appear on the Control Display.









## Indicator/warning lamps

The indicator and warning lamps in the instrument cluster can light up in a variety of combinations and colors.

Several of the lamps are checked for proper functioning and light up temporarily when the engine is started or the ignition is switched on.

## Overview: indicator/warning lamps

Symbol	Function or system
	Turn signal.
	Parking brake.
	Parking brake in Canadian models.
	Automatic hold.
	Front fog lamps.
	High beams.
	High-beam Assistant.
	Parking lamps, headlamp control.
	Vehicle detection, Active Cruise Control: collision warning.
	Cruise control.
	Lane departure warning.
	DSC Dynamic Stability Control.
	DSC Dynamic Stability Control or DTC Dynamic Traction Control
	Tire Pressure Monitor. Flat Tire Monitor.

Symbol	Function or system
	Safety belts.
	Airbag system.
	Steering system.
	Engine functions.
	Brake system.
	Brake system in Canadian models.
	ABS Antilock Brake System.
	ABS Antilock Brake System in Canadian models.
	At least one Check Control message is displayed or is stored.

### Text messages

Text messages in combination with a symbol in the instrument cluster explain a Check Control message and the meaning of the indicator and warning lamps.



### Supplementary text messages

Additional information, such as on the cause of a fault or the required action, can be called up via Check Control.

The supplementary text of urgent messages is automatically displayed on the Control Display.

## Symbols

Depending on the Check Control message, the following functions can be selected.

- ▷  "Owner's Manual"  
Display additional information about the Check Control message in the Integrated Owner's Manual.
- ▷  "Service request"  
Contact your service center.
- ▷  "Roadside Assistance"  
Contact Roadside Assistance.

## Hiding Check Control messages

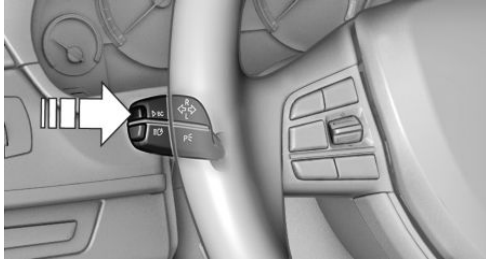

Press the onboard computer button on the turn signal lever.

- ▷ Some Check Control messages are displayed continuously and are not cleared until the malfunction is eliminated. If several malfunctions occur at once, the messages are displayed consecutively.  
These messages can be hidden for approx. 8 seconds. After this time, they are displayed again automatically.
- ▷ Other Check Control messages are hidden automatically after approx. 20 seconds. They are stored and can be displayed again later.

## Displaying stored Check Control messages

1. "Vehicle Info"
2. "Vehicle status"

3.  "Check Control"
4. Select the text message.

## Messages after trip completion

Special messages that are displayed during driving are displayed again after the ignition is switched off.

## Fuel gauge



The vehicle inclination may cause the display to vary.

US models: the arrow beside the fuel pump symbol shows which side of the vehicle the fuel filler

flap is on.

Hints on refueling, refer to page 204.

## Tachometer

Always avoid engine speeds in the red warning field. In this range, the fuel supply is interrupted to protect the engine.

## Engine oil temperature



- ▷ Cold engine: the pointer is at the low temperature end. Drive at moderate engine and vehicle speeds.
- ▷ Normal operating temperature: the pointer is in the middle or in the left half of the temperature display.
- ▷ Hot engine: the pointer is at the high end of the temperature range. A Check Control message is also displayed.



## Coolant temperature

If the coolant along with the engine becomes too hot, a Check Control message is displayed. Check the coolant level, refer to page 227.

## Odometer and trip odometer

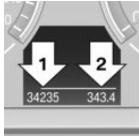

- ▷ Odometer, arrow 1.
- ▷ Trip odometer, arrow 2.

## Show/reset kilometers



Press the knob.

- ▷ When the ignition is switched off, the time, the external temperature and the odometer are displayed.
- ▷ When the ignition is switched on, the trip odometer is reset.

## External temperature

### External temperature warning

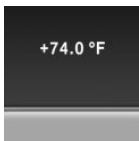

If the indicator drops to +37 °F/+3 °C or lower, a signal sounds.

A Check Control message is displayed.

There is an increased risk of ice on roads.



Ice on roads

Even at temperatures above +37 °F/+3 °C, there can be a risk of ice on roads.

Therefore, drive carefully on bridges and shaded roads, for example, to avoid the increased risk of an accident. ◀

## Time

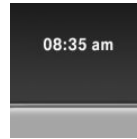

The time is displayed at the bottom of the instrument cluster. Setting the time and time format, refer to page 95.

## Date

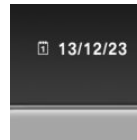

The date is displayed in the computer. Setting the date and date format, refer to page 96.

## Range

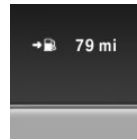

After the reserve range is reached:

- ▷ A Check Control message is displayed briefly.
- ▷ The remaining range is shown on the onboard computer.
- ▷ When a dynamic driving style is used, such as when cornering quickly, operation of the engine is not always ensured.

The Check Control message appears continuously below a range of approx. 30 miles/50 km.



Refuel promptly

Refuel no later than at a range of 30 miles/50 km, or operation of the engine is not ensured and damage may occur. ◀

## Displaying the cruising range

1. "Settings"
2. "Info display"
3. "Additional indicators"

The range is displayed in the instrument cluster.

## Current fuel consumption

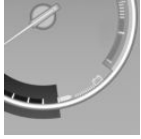

Displays the current fuel consumption. You can check whether you are currently driving in an efficient and environmentally-friendly manner.

### Displaying the current fuel consumption

1. "Settings"
2. "Info display"
3. "Additional indicators"

The bar display for the current fuel consumption is displayed in the instrument cluster.

## Energy recovery



The kinetic energy of the vehicle is converted to electrical energy while coasting. The vehicle battery is partially charged and fuel consumption can be reduced.

## Service requirements

### Display

The driving distance or the time to the next scheduled maintenance is displayed briefly in the instrument cluster after the ignition is switched on.

The current service requirements can be read out from the remote control by the service specialist.



With TeleService, data regarding the service status or legally mandated inspections of your vehicle are automatically transmitted to your service center before the service due date.

### Detailed information on service requirements

More information on the scope of service required can be displayed on the Control Display.

1. "Vehicle Info"
2. "Vehicle status"
3.  "Service required"  
Required maintenance procedures and legally mandated inspections are displayed.
4. Select an entry to call up detailed information.

### Symbols

Symbols	Description
	No service is currently required.
	The deadline for service or a legally mandated inspection is approaching.
	The service deadline has already passed.

### Entering appointment dates

Enter the dates for the required inspections. Ensure that the vehicle date and time are set correctly.

1. "Vehicle Info"
2. "Vehicle status"
3.  "Service required"
4. "\$ Vehicle inspection"
5. "Date:"
6. Adjust the settings.
7. Confirm.  
The entered date is stored.

## Automatic Service Request

Data regarding the service status or legally mandated inspections of the vehicle are automatically transmitted to your service center before a service due date.

You can check when your service center was notified.

1. "Vehicle Info"
2. "Vehicle status"
3. Open "Options".
4. "Last Service Request"

## Gear shift indicator

### The concept



The system recommends the most fuel efficient gear for the current driving situation.

Depending on how the vehicle is equipped and the country-specific version of the vehicle, the gear shift indicator is active in the manual mode of the automatic transmission.

Indicators to shift up or down are displayed in the instrument cluster.

On vehicles without a gear shift indicator, the engaged gear is displayed.

### Displays

Example	Description
	Fuel efficient gear is engaged.
	Shift into fuel efficient gear.

## Speed limit detection with No Passing Information

### The concept

#### Speed limit detection

Speed limit detection uses a symbol in the shape of a traffic sign to display the currently detected speed limit. The camera at the base of the interior rearview mirror detects traffic signs at the edge of the road as well as variable overhead sign posts. Traffic signs with extra symbols for wet road conditions, etc. are also detected and compared with vehicle interior data, such as for the rain sensor, and are displayed depending on the situation. The system takes into account the information stored in the navigation system and also displays speed limits present on routes without signs.

#### No Passing Information

No Passing Information in the instrument cluster displays the beginnings and ends of no passing zones detected by the camera. The system accounts for only the beginnings and ends of No Passing zones marked by signs.

No display is shown:

- ▷ In countries where No Passing zones are primarily identified with road markings.
- ▷ On routes without signage.
- ▷ Where there are railroad crossings, highway markings or other situations where no signage is present, but passing would not be permitted.

### Hints



Personal judgment

The system cannot serve as a substitute for the driver's personal judgment of the traffic situation.

The system assists the driver and does not replace the human eye. ◀

## At a glance

### Camera

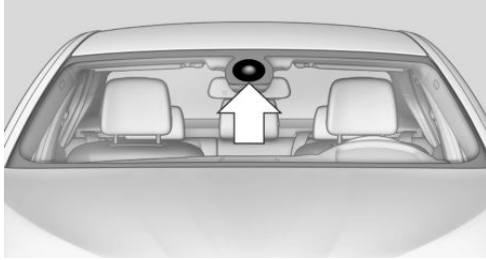

The camera is located near the base of the mirror.

Keep the windshield in the area behind the interior rear view mirror clean and clear.

### Switching on/off

1. "Settings"
2. "Info display"
3. "Speed limit information"

If speed limit detection is switched on, it can be displayed on the info display in the instrument cluster via the onboard computer. No Passing Information is displayed together with the activated speed limit information.

### Display

The following is displayed in the instrument cluster.

#### Speed limit detection

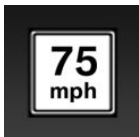

Current speed limit.



Speed limit detection is not available.

Speed limit detection can also be displayed in the Head-up Display.

### No Passing Information



- ▷ Start of No Passing zone.
- ▷ End of No Passing zone.
- ▷ No Passing Information not available.

No Passing Information can also be displayed in the Head-up Display.

### System limits

The system may not be fully functional and may provide incorrect information in the following situations:

- ▷ In heavy fog, rain or snowfall.
- ▷ When signs are concealed by objects.
- ▷ When driving very close to the vehicle in front of you.
- ▷ When driving toward bright lights.
- ▷ When the windshield behind the interior rearview mirror is fogged over, dirty or covered by a sticker, etc.
- ▷ In the event of incorrect detection by the camera.
- ▷ If the speed limits stored in the navigation system are incorrect.
- ▷ In areas not covered by the navigation system.
- ▷ When roads differ from the navigation, such as due to changes in the road network.
- ▷ When passing buses or trucks with a speed sticker.
- ▷ If the traffic signs are non-conforming.
- ▷ During calibration of the camera immediately after vehicle shipment.

## Selection lists in the instrument cluster

### The concept



The following can be operated using the buttons and the thumbwheel on the steering wheel:

- ▷ Current audio source.
- ▷ Redial on telephone.
- ▷ Activation of the voice activation system.

### Activating a list and creating the setting

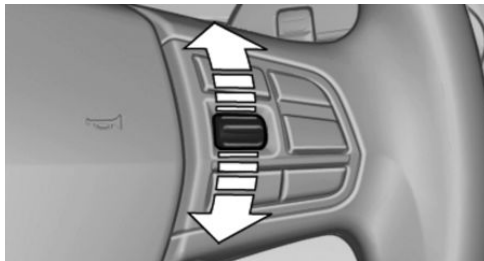

On the right side of the steering wheel, turn the thumbwheel to activate the corresponding list.

Using the thumbwheel, select the desired setting and confirm it by pressing the thumbwheel.

## Computer

### Indication in the info display

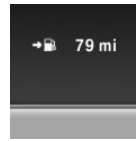

The information from the on-board computer is shown in the info display in the instrument cluster.

### Calling up information on the info display

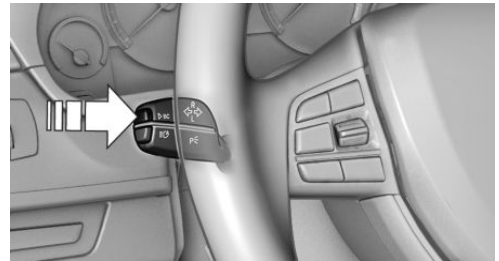

Press the onboard computer button on the turn signal lever.

Information is displayed on the info display of the instrument cluster.

### Information at a glance

Repeatedly pressing the button on the turn signal lever calls up the following information on the info display:

- ▷ Range.
- ▷ Average fuel consumption.
- ▷ Average speed.
- ▷ Date.
- ▷ Speed limit detection.
- ▷ Time of arrival.

When destination guidance is activated in the navigation system.

- ▷ Distance to destination.

When destination guidance is activated in the navigation system.

- ▷ Arrow view of navigation system.

When destination guidance is activated in the navigation system.

When the arrow view in the Head-up Display is inactive.

- ▷ Compass display in the navigation system.

## Adjusting the info display

You can select what information from the onboard computer is to be displayed on the info display of the instrument cluster.

1. "Settings"
2. "Info display"
3. Select the desired displays.

## Information in detail

### Range

Displays the estimated cruising range available with the remaining fuel.

It is calculated based on your driving style over the last 20 miles/30 km.

### Average fuel consumption

The average fuel consumption is calculated for the period during which the engine is running.

The average fuel consumption is calculated for the distance traveled since the last reset by the onboard computer.

### Average speed

Periods in which the vehicle is parked with the engine manually stopped do not enter into the calculation of the average speed.

### Resetting average values

Press and hold the computer button on the turn signal lever.

### Distance to destination

The distance remaining to the destination is displayed if a destination is entered in the navigation system before the trip is started.

The distance to the destination is adopted automatically.

## Time of arrival

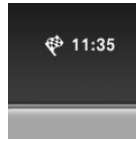

The estimated time of arrival is displayed if a destination is entered in the navigation system before the trip is started.

The time must be correctly set.

## Speed limit detection

Description of the speed limit detection, refer to page 91, function.

## Compass

With Professional navigation system: compass display for the driving direction.

## Speed limit

Display of a speed limit which, when reached, should cause a warning to be issued.

The warning is repeated if the vehicle speed drops below the set speed limit once by at least 3 mph/5 km/h.

## Displaying, setting or changing the limit

1. "Settings"
2. "Speed"
3. "Warning at:"
4. Turn the controller until the desired limit is displayed.

5. Press the controller.

The speed limit is stored.

## Activating/deactivating the limit

1. "Settings"
2. "Speed"
3. "Warning"
4. Press the controller.

## Setting your current speed as the limit

1. "Settings"
2. "Speed"
3. "Select current speed"
4. Press the controller.  
The current vehicle speed is stored as the limit.

## Trip computer

The vehicle features two types of computer.

- "Onboard info": the values can be reset as often as necessary.
- "Trip computer": the values provide an overview of the current trip.

## Resetting the trip computer

1. "Vehicle Info"
2. "Trip computer"
3. "Reset": all values are reset.  
"Automatically reset": all values are reset approx. 4 hours after the vehicle comes to a standstill.

## Display on the Control Display

Display the onboard computer or trip computer on the Control Display.

1. "Vehicle Info"
2. "Onboard info" or "Trip computer"

## Resetting the fuel consumption or speed

1. "Vehicle Info"
2. "Onboard info"
3. "Consumpt." or "Speed"
4. "Yes"

## Sport displays

In the Control Display, the current values for power and torque can be displayed if the vehicle is appropriately equipped.

## Displaying sport displays in the Control Display

1. "Vehicle Info"
2. "Sport displays"

## Settings on the Control Display

### Time

#### Setting the time zone

1. "Settings"
2. "Time/Date"
3. "Time zone"
4. Select the desired time zone.  
The time zone is stored.

#### Setting the time

1. "Settings"
2. "Time/Date"
3. "Time:"
4. Turn the controller until the desired hours are displayed.
5. Press the controller.
6. Turn the controller until the desired minutes are displayed.
7. Press the controller.  
The time is stored.

#### Setting the time format

1. "Settings"
2. "Time/Date"
3. "Format:"
4. Select the desired format.

The time format is stored.

## Date

### Setting the date

1. "Settings"
2. "Time/Date"
3. "Date:"
4. Turn the controller until the desired day is displayed.
5. Press the controller.
6. Make the necessary settings for the month and year.

The date is stored.

### Setting the date format

1. "Settings"
2. "Time/Date"
3. "Format:"
4. Select the desired format.

The date format is stored.

## Language

### Setting the language

To set the language on the Control Display:

1. "Settings"
2. "Language/Units"
3. "Language:"
4. Select the desired language.

The setting is stored for the remote control currently in use.

### Setting the voice dialog

Voice dialog for the voice activation system, refer to page [27](#).

## Units of measure

### Setting the units of measure

To set the units for fuel consumption, route/distance and temperature:

1. "Settings"
2. "Language/Units"
3. Select the desired menu item.
4. Select the desired unit.

The setting is stored for the remote control currently in use.

## Brightness

### Setting the brightness

To set the brightness of the Control Display:

1. "Settings"
2. "Control display"
3. "Brightness"
4. Turn the controller until the desired brightness is set.
5. Press the controller.

The setting is stored for the remote control currently in use.

Depending on the light conditions, the brightness control may not be clearly visible.



## Head-up Display

### The concept

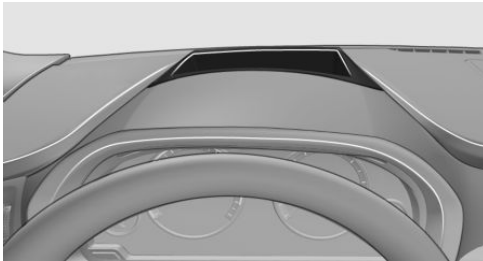

This system projects important information into the driver's field of vision, e.g., the speed.

The driver can get information without averting his or her eyes from the road.

### Display visibility

The visibility of the displays in the Head-up Display is influenced by the following factors:

- ▷ Certain sitting positions.
- ▷ Objects on the cover of the Head-up Display.
- ▷ Sunglasses with certain polarization filters.
- ▷ Wet roads.
- ▷ Unfavorable light conditions.

If the image is distorted, check the basic settings.

### Switching on/off

1. "Settings"
2. "Head-Up Display"
3. "Head-Up Display"

### Display

#### Overview

- ▷ Speed.
- ▷ Navigation system.
- ▷ Check Control messages.
- ▷ Collision warning.

- ▷ Speed limit detection.
- ▷ Cruise control.
- ▷ Distance information.
- ▷ Congestion Assistant.
- ▷ Pedestrian warning.
- ▷ Selection list from the instrument cluster.

Some of this information is only displayed briefly as needed.

### Selecting displays in the Head-up Display

1. "Settings"
2. "Head-Up Display"
3. "Displayed information"
4. Select the desired displays in the Head-up Display.

The settings are stored for the remote control currently in use.

### Setting the brightness

The brightness is automatically adjusted to the ambient light.

The basic setting can be adjusted manually.

1. "Settings"
2. "Head-Up Display"
3. "Brightness"
4. Turn the controller.

When the low beams are switched on, the brightness of the Head-up Display can be additionally influenced using the instrument lighting.

The setting is stored for the remote control currently in use.

### Adjusting the height

1. "Settings"
2. "Head-Up Display"
3. "Height"
4. Turn the controller.

The setting is stored for the remote control currently in use.

### Setting the rotation

1. "Settings"
2. "Head-Up Display"
3. "Rotation"
4. Turn the controller.

The setting is stored for the remote control currently in use.

### Special windshield

The windshield is part of the system.

The shape of the windshield makes it possible to display a precise image.

A film in the windshield prevents double images from being displayed.

Therefore, have the special windshield replaced by a service center only.

# Lamps

## Vehicle equipment

All standard, country-specific and optional equipment that is offered in the model series is described in this chapter. Therefore, equipment is also described that is not available in a vehicle, e. g., because of the selected optional equipment or country variant. This also applies for safety-related functions and systems.

## At a glance

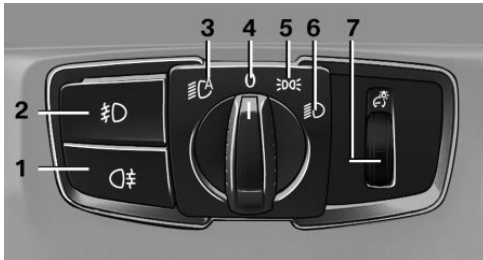

- 1 Rear fog lamps
- 2 Front fog lamps
- 3 Automatic headlamp control, Adaptive Light Control, High-beam Assistant, Welcome lamps, Daytime running lights
- 4 Lamps off, daytime running lights
- 5 Parking lamps, daytime running lights
- 6 Low beams, welcome lamps, High-beam Assistant
- 7 Instrument lighting

## Parking lamps/low beams, headlamp control

### General information

Switch position: 0, , 

If the driver door is opened with the ignition switched off, the exterior lighting is automatically switched off at these switch settings.

### Parking lamps

Switch position  : the vehicle lamps light up on all sides, e.g., for parking.



Do not use the parking lamps for extended periods; otherwise, the vehicle battery may become discharged and it would then be impossible to start the engine.

When parking, it is preferable to switch on the one-sided roadside parking lamps, refer to page 100.

### Low beams

Switch position  with the ignition switched on: the low beams light up.

### Welcome lamps

When the vehicle is parked, leave the switch in position  or  : parking and interior lamps come on briefly when the vehicle is unlocked depending on the ambient light.

### Activating/deactivating

1. "Settings"
2. "Lighting"
3. "Welcome lights"

The setting is stored for the remote control currently in use.

### Headlamp courtesy delay feature

The low beams stay lit for a short while if the headlamp flasher is switched on after the ignition is switched off.

### Setting the duration

1. "Settings"
2. "Lighting"

3. "Pathway lighting:"
4. Set the duration.

The setting is stored for the remote control currently in use.

### Automatic headlamp control

Switch position  : the low beams are switched on and off automatically, e.g., in tunnels, in twilight or if there is precipitation. The indicator lamp in the instrument cluster lights up.

A blue sky with the sun low on the horizon can cause the lights to be switched on.

The low beams always stay on when the fog lamps are switched on.





#### Personal responsibility

The automatic headlamp control cannot serve as a substitute for your personal judgment in determining when the lamps should be switched on in response to ambient lighting conditions.

For example, the sensors are unable to detect fog or hazy weather. To avoid safety risks, you should always switch on the lamps manually under these conditions. ◀

### Daytime running lights

With the ignition switched on, the daytime running lights light up in position 0,  or  . After the ignition is switched off, the parking lamps light up in position  .

### Activating/deactivating

In some countries, daytime running lights are compulsory, so it may not be possible to deactivate the daytime running lights.

1. "Settings"
2. "Lighting"
3. "Daytime running lamps"

The setting is stored for the remote control currently in use.

### Roadside parking lamps

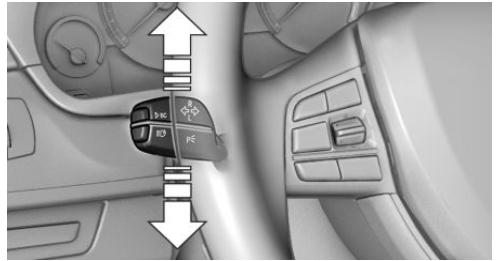

The vehicle can be illuminated on one side.

### Switching on

With the ignition switched off, press the lever either up or down past the resistance point for approx. 2 seconds.

### Switching off

Briefly press the lever to the resistance point in the opposite direction.

## Adaptive Light Control

### The concept

Adaptive Light Control is a variable headlamp control system that enables dynamic illumination of the road surface.

Depending on the steering angle and other parameters, the light from the headlamp follows the course of the road.

In tight curves, e.g., on mountainous roads or when turning, an additional, corner-illuminating lamp is switched on that lights up the inside of the curve when the vehicle is moving below a certain speed.

### Activating

Switch position  with the ignition switched on.

The cornering lamps are automatically switched on depending on the steering angle or the use of turn signals.

To avoid blinding oncoming traffic, the Adaptive Light Control does not swivel to the driver's side when the vehicle is at a standstill.

When driving in reverse, only the cornering lamp is active.

## Self-leveling headlamps

The self-leveling headlamps compensate for acceleration and braking operations in order not to blind the oncoming traffic and to achieve optimum illumination of the roadway.

## Malfunction

A Check Control message is displayed.

Adaptive light control is malfunctioning or has failed. Have the system checked as soon as possible.

## High-beam Assistant



### The concept

When the low beams are switched on, this system automatically switches the high beams on and off. The procedure is controlled by a sensor on the front of the interior rearview mirror. The assistant ensures that the high beams are switched on whenever the traffic situation allows. The driver can intervene at any time and switch the high beams on and off as usual.

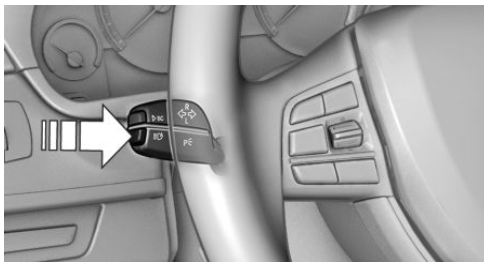
### Activating



The High-beam Assistant can be activated when the low beams are switched on.

1. Turn the light switch to  or .
2. Press the button on the turn signal lever, arrow.



The indicator lamp in the instrument cluster lights up.

When the low beams are on, the lights are automatically brightened or dimmed.

The system responds to light from oncoming traffic and traffic driving ahead of you, and to adequate illumination, e.g., in towns and cities.



The blue indicator lamp in the instrument cluster lights up when the system switches on the high beams. Depending on the version of the system in the vehicle, the high beams may not switch off for oncoming vehicles, but may only be dimmed in the areas that blind oncoming traffic. In this case, the blue indicator light will stay on.

### Switching the high beams on and off manually

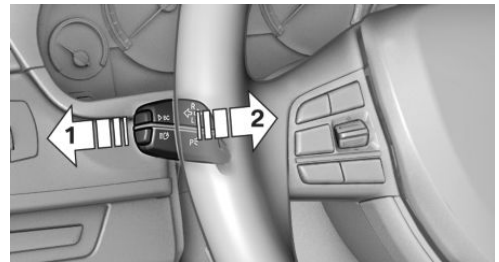

- ▷ High beams on, arrow 1.
- ▷ High beams off/headlamp flasher, arrow 2.

The High-beam Assistant can be switched off when manually adjusting the light. To reactivate the High-beam Assistant, press the button on the turn signal lever.

## System limits



### Personal responsibility

The high-beam assistant cannot serve as a substitute for the driver's personal judgment of when to use the high beams. Therefore, manually switch off the high beams in situations where this is required to avoid a safety risk. ◀

The system is not fully functional in situations such as the following, and driver intervention may be necessary:

- ▷ In very unfavorable weather conditions, such as fog or heavy precipitation.
- ▷ In detecting poorly-lit road users, such as pedestrians, cyclists, horseback riders and wagons; when driving close to train or ship traffic; and at animal crossings.
- ▷ In tight curves, on hilltops or in depressions, in cross traffic or half-obscured on-coming traffic on freeways.
- ▷ In poorly-lit towns and cities and in the presence of highly reflective signs.
- ▷ At low speeds.
- ▷ When the windshield in front of the interior rearview mirror is fogged over, dirty or covered with stickers, etc.

## Camera

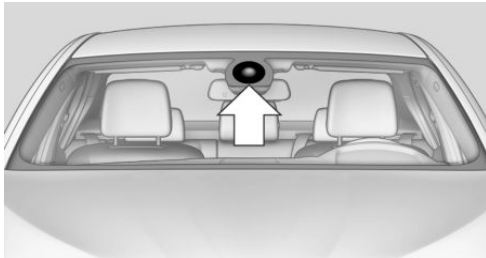

The camera is located near the base of the mirror.

Keep the windshield in the area behind the interior rear view mirror clean and clear.

## Fog lamps

### Front fog lamps

The low beams must be switched on.



Press the button. The green indicator lamp lights up.

If the automatic headlamp control, refer to page 100, is activated, the low beams will come on automatically when you switch on the front fog lamps.

## Instrument lighting

### Adjusting



The parking lamps or low beams must be switched on to adjust the brightness.

Adjust the brightness using the thumbwheel.

## Interior lamps

### General information

The interior lamps, footwell lamps, entry lamps and courtesy lamps are controlled automatically.

The brightness of some of these lamps is influenced by the thumbwheel for the instrument lighting.



- 1 Interior lamps
- 2 Reading lamp

## Switching the interior lamps on and off



Press the button.

To switch off permanently: press the button for approx. 3 seconds.

Switch back on: press button.

## Reading lamps



Press the button.

Reading lamps are located at the front and rear next to the interior lamps.

## Ambient light

Depending on the equipment, the lighting can be adjusted in the interior for some lights.

## Selecting color scheme

1. "Settings"
2. "Lighting"
3. "Lighting design"
4. Select the desired setting.

To deactivate the ambient light: "Off".

## Setting the brightness

The brightness of the ambient light can be adjusted via the thumbwheel for the instrument lighting or on the Control Display.

1. "Settings"
2. "Lighting"
3. "Brightness:"
4. Adjust the brightness.

# Safety

## Vehicle equipment

All standard, country-specific and optional equipment that is offered in the model series is described in this chapter. Therefore, equip-

ment is also described that is not available in a vehicle, e. g., because of the selected optional equipment or country variant. This also applies for safety-related functions and systems.

## Airbags

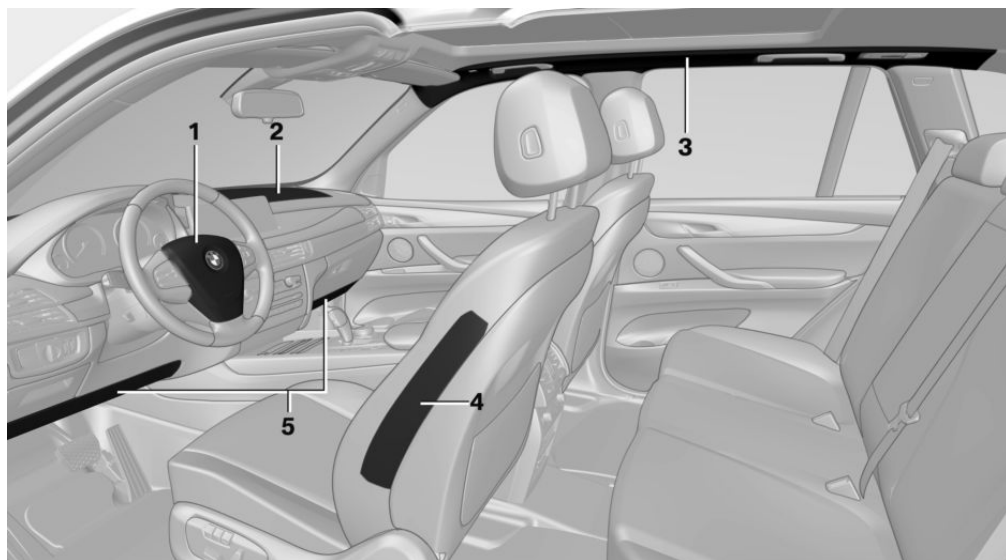

1 Front airbag, driver

2 Front airbag, front passenger

3 Head airbag

4 Side airbag

5 Knee airbags

### Front airbags

Front airbags help protect the driver and front passenger by responding to frontal impacts in which safety belts alone cannot provide adequate restraint.

### Side airbags

In a lateral impact, the side airbag supports the side of the body in the chest and lap area.

### Head airbags

In a lateral impact, the head airbag supports the head.

### Knee airbag

The knee airbag supports the legs in a frontal impact.



## Protective action

Airbags are not triggered in every impact situation, e.g., in less severe accidents or rear-end collisions.

 Information on how to ensure the optimal protective effect of the airbags

- ▶ Keep at a distance from the airbags.
- ▶ Always grasp the steering wheel on the steering wheel rim, holding your hands at the 3 o'clock and 9 o'clock positions, to keep the danger of injury to your hands or arms as low as possible if the airbag is triggered.
- ▶ There should be no people, animals, or objects between an airbag and a person.
- ▶ Do not use the cover of the front airbag on the front passenger side as a storage area.
- ▶ Keep the dashboard and window on the front passenger side clear, i.e., do not cover with adhesive labels or coverings, and do not attach holders such as for navigation instruments and mobile phones.
- ▶ Make sure that the front passenger is sitting correctly, i.e., keeps his or her feet and legs in the footwell; otherwise, leg injuries can occur if the front airbag is triggered.
- ▶ Do not place slip covers, seat cushions or other objects on the front passenger seat that are not approved specifically for seats with integrated side airbags.
- ▶ Do not hang pieces of clothing, such as jackets, over the backrests.
- ▶ Make sure that occupants keep their heads away from the side airbag and do not rest against the head airbag; otherwise, injuries can occur if the airbags are triggered.
- ▶ Do not remove the airbag restraint system.
- ▶ Do not remove the steering wheel.
- ▶ Do not apply adhesive materials to the airbag cover panels, cover them or modify them in any way.

- ▶ Never modify either the individual components or the wiring in the airbag system. This also applies to steering wheel covers, the dashboard, the seats, the roof pillars and the sides of the headliner. ◀

Even when all instructions are followed closely, injury from contact with the airbags cannot be ruled out in certain situations.

The ignition and inflation noise may lead to short-term and, in most cases, temporary hearing impairment in sensitive individuals.

 In the case of a malfunction, deactivation and after triggering of the airbags

Do not touch the individual components immediately after the system has been triggered; otherwise, there is the danger of burns.

Only have the airbags checked, repaired or dismantled and the airbag generator scrapped by the service center or a workshop that has the necessary authorization for handling explosives.

Non-professional attempts to service the system could lead to failure in an emergency or undesired triggering of the airbag, either of which could result in injury. ◀

Warnings and information on the airbags are also found on the sun visors.

## Functional readiness of the airbag system

 When the ignition is switched on, the warning lamp in the instrument cluster lights up briefly and thereby indicates the operational readiness of the entire airbag system and the belt tensioner.

## Airbag system malfunctioning

- ▶ Warning lamp does not come on when the ignition is turned on.
- ▶ The warning lamp lights up continuously.

 When there is a malfunction, have the airbag system checked immediately

When there is a malfunction, have the airbag system checked immediately; otherwise, there is a risk that the system does not function as expected in the event of an accident despite corresponding severity of the accident. ◀

### Automatic deactivation of the front passenger airbags

The system determines whether the front passenger seat is occupied by measuring the resistance of the human body.

The front, knee, and side airbag on the front passenger side are activated or deactivated accordingly.

 Leave feet in the footwell

Make sure that the front passenger keeps his or her feet in the footwell; otherwise, the front passenger airbags may not function properly. ◀

 Child restraint fixing system in the front passenger seat

Before transporting a child on the front passenger seat, refer to the safety notes and instructions under Children on the front passenger seat. ◀

### Malfunction of the automatic deactivation system

When transporting older children and adults, the front passenger airbags may be deactivated in certain sitting positions. In this case, the indicator lamp for the front passenger airbags lights up.

In this case, change the sitting position so that the front passenger airbags are activated and the indicator lamp goes out.

If it is not possible to activate the airbags, have the person sit in the rear.

To make sure that the occupied seat cushion can be evaluated correctly

- ▶ Do not attach covers, cushions, ball mats or other items to the front passenger seat unless they are specifically recommended by the manufacturer of your vehicle.
- ▶ Do not place any electronic devices on the passenger seat if a child restraint system is to be installed on it.
- ▶ Do not place objects under the seat that could press against the seat from below.
- ▶ No moisture in or on the seat.

### Indicator lamp for the front passenger airbags



The indicator lamp for the front passenger airbags indicates the operating state of the front passenger airbags.

The lamp indicates whether the airbags are activated or deactivated.



- ▶ The indicator lamp lights up when a child who is properly seated in a child restraint fixing system intended for that purpose is detected on the seat or the seat is empty. The airbags on the front passenger side are not activated.
- ▶ The indicator lamp does not light up when, for example, a correctly seated person of sufficient size is detected on the seat. The airbags on the front passenger side are activated.

## Detected child seats

The system generally detects children seated in a child seat, especially in the child seats that were required by NHTSA when the vehicle was manufactured. After installing a child seat, make sure that the indicator lamp for the front passenger airbags lights up. This indicates that the child seat has been detected and the front passenger airbags are not activated.

## Strength of the driver's and front passenger airbag

The strength with which the driver's and front passenger airbags are triggered depends on the position of the driver's and front passenger seats.

To maintain the accuracy of this function over the long-term, calibrate the front seats when a corresponding message appears on the Control Display.

## Calibrating the front seats

A corresponding message appears on the Control Display.

1. Move the respective seat forward all the way.
2. Move the respective seat forward again. It moves forward briefly.
3. Readjust the seat to the desired position.

The calibration procedure is completed when the message on the Control Display disappears.

If the message continues to be displayed, repeat the calibration.

If the message does not disappear after a repeat calibration, have the system checked as soon as possible.



Unobstructed area of movement

Ensure that the area of movement of the seats is unobstructed to avoid personal injury or damage to objects. ◀

## Tire Pressure Monitor TPM

### The concept

The system monitors tire pressure in the four mounted tires. The system warns you if there is a significant loss of pressure in one or more tires. For this purpose, sensors in the tire valves measure the tire inflation pressure.

### Hints



Tire damage due to external factors

Sudden tire damage caused by external influences cannot be indicated in advance. ◀

Pay attention to the other information and indications under Tire inflation pressure, refer to page 211, as well when using the system.

### Functional requirements

The system must have been reset with the correct tire inflation pressure; otherwise, reliable signaling of tire pressure loss is not ensured.

Reset the system again after each correction of the tire inflation pressure and after every tire or wheel change.

Always use wheels with TPM electronics to ensure that the system will operate properly.

### Status display

The current status of the Tire Pressure Monitor TPM can be displayed on the Control Display, e.g., whether or not the TPM is active.

1. "Vehicle Info"
2. "Vehicle status"
3. (⚠) "Tire Pressure Monitor (TPM)"

The status is displayed.

### Status display

The tire and system status is indicated by the color of the wheels and a text message on the Control Display.

## All wheels green

System is active and will issue a warning relative to the tire inflation pressures stored during the last reset.

## One wheel is yellow

A flat tire or major drop in inflation pressure in the indicated tire.

## All wheels are yellow

A flat tire or major drop in inflation pressure in several tires.

## Wheels, gray

The system cannot detect a flat tire. Reasons for this may be:

- ▷ The system is being reset.
- ▷ Malfunction.

## Additional information

The status display additionally shows the current tire inflation pressures. The values shown are current measurement values and may vary depending on driving style or weather conditions.

## Carry out reset

Reset the system after each correction of the tire inflation pressure and after every tire or wheel change.

1. "Vehicle Info"
2. "Vehicle status"
3.  "Perform reset"
4. Start the engine - do not drive away.
5. Carry out the reset with "Perform reset".
6. Drive away.

The tires are shown in gray and the status is displayed.

After driving faster than 19 mph/30 km/h for a short period, the tire inflation pressures set are accepted as reference values. The reset is completed automatically during driving.

The progress of the reset is displayed.

After a successfully completed Reset, the wheels on the Control Display are shown in green and "Tire Pressure Monitor (TPM) active" is displayed.

The trip can be interrupted at any time. If you drive away again, the reset resumes automatically.

## Low tire pressure message



The yellow warning lamp lights up. A Check Control message is displayed.

- ▷ There is a flat tire or a major loss in tire inflation pressure.
  - ▷ No reset was performed for the system. The system therefore issues a warning based on the tire inflation pressures before the last reset.
1. Reduce your speed and stop cautiously. Avoid sudden braking and steering maneuvers.
  2. Check whether the vehicle is fitted with regular tires or run-flat tires. Run-flat tires, refer to page 220, are labeled with a circular symbol containing the letters RSC marked on the tire sidewall.



Do not continue driving without run-flat tires

Do not continue driving if the vehicle is not equipped with run-flat tires; continued driving may result in serious accidents. ◀

When a low inflation pressure is indicated, DSC Dynamic Stability Control is switched on if necessary.

## Actions in the event of a flat tire

### Normal tires

1. Identify the damaged tire.

Do this by checking the air pressure in all four tires.

If the tire inflation pressure in all four tires is correct, it is possible that a reset was not carried out for the Tire Pressure Monitor. Then perform the reset.

If an identification is not possible, please contact the service center.

## 2. Rectify the flat tire.

Use of tire sealant, e.g., the Mobility System, may damage the TPM wheel electronics. In this case, have the electronics checked at the next opportunity and have them replaced if necessary.

## Run-flat tires

### Maximum speed

You can continue driving with a damaged tire at speeds up to 50 mph/80 km/h.

### Continued driving with a flat tire

If continuing to drive with a damaged tire:

1. Avoid sudden braking and steering maneuvers.
2. Do not exceed a speed of 50 mph/80 km/h.
3. Check the air pressure in all four tires at the next opportunity.

If the tire inflation pressure in all four tires is correct, it is possible that a reset was not carried out for the Tire Pressure Monitor. In that case, carry out a reset.

Possible driving distance with complete loss of tire inflation pressure:

The possible driving distance after a loss of tire inflation pressure depends on the cargo load and the driving style and conditions.

For a vehicle containing an average load, the possible driving distance is approx. 50 miles/80 km.

When the vehicle is driven with a damaged tire, its handling characteristics change, e.g., reduced lane stability during braking, a longer braking distance, and altered self-steering properties. Adjust your driving style accord-

ingly. Avoid abrupt steering maneuvers or driving over obstacles, e.g., curbs, potholes, etc.

Because the possible driving distance depends on how the vehicle is used during the trip, the actual distance may be smaller or greater depending on the driving speed, road conditions, external temperature, cargo load, etc.



### Continued driving with a flat tire

Drive moderately and do not exceed a speed of 50 mph/80 km/h.

A loss of tire inflation pressure results in a change in the handling characteristics, e.g., reduced lane stability during braking, a longer braking distance and altered self-steering properties. ◀



### Final tire failure

Vibrations or loud noises while driving can indicate the final failure of the tire. Reduce speed and stop; otherwise, pieces of the tire could come loose and cause an accident. Do not continue driving, and contact your service center. ◀

## Required inflation pressure check message

A Check Control message is displayed.

Check the tire inflation pressure and carry out a reset of the system.

In some cases, a wheel was changed without having carried out a reset.

## System limits

The system does not function properly if a reset has not been carried out, e.g., a flat tire is reported even though the tire inflation pressures are correct.

The tire pressure depends on the temperature of the tire. If the tire temperature rises, e.g., due to driving or because of the heat of the Sun, the tire inflation pressure increases also. The tire pressure is reduced when the tire

temperature falls again. This behavior may cause a warning to be issued if temperatures fall very sharply.

## Malfunction



The yellow warning lamp flashes and then lights up continuously. A Check Control message is displayed. No flat tire or loss of tire pressure can be detected.

Display in the following situations:

- ▷ A wheel without TPM electronics is fitted: have the service center check it if necessary.
- ▷ A wheel without TPM electronics, such as a compact wheel, is mounted: have the service center check it if necessary.
- ▷ Malfunction: have the system checked by your service center.
- ▷ TPM was unable to complete the reset. Reset the system again.
- ▷ Disturbance by systems or devices with the same radio frequency: after leaving the area of the disturbance, the system automatically becomes active again.

## Declaration according to NHTSA/ FMVSS 138 Tire Pressure Monitoring System

Each tire, including the spare (if provided) should be checked monthly when cold and inflated to the inflation pressure recommended by the vehicle manufacturer on the vehicle placard or tire inflation pressure label. (If your vehicle has tires of a different size than the size indicated on the vehicle placard or tire inflation pressure label, you should determine the proper tire inflation pressure for those tires.) As an added safety feature, your vehicle has been equipped with a tire pressure monitoring system (TPMS) that illuminates a low tire pressure telltale when one or more of your tires is significantly under-inflated. Accordingly, when the low tire pressure telltale illuminates, you should stop and check your tires as soon as

possible, and inflate them to the proper pressure. Driving on a significantly under-inflated tire causes the tire to overheat and can lead to tire failure. Under-inflation also reduces fuel efficiency and tire tread life, and may affect the vehicle's handling and stopping ability. Please note that the TPMS is not a substitute for proper tire maintenance, and it is the driver's responsibility to maintain correct tire pressure, even if under-inflation has not reached the level to trigger illumination of the TPMS low tire pressure telltale. Your vehicle has also been equipped with a TPMS malfunction indicator to indicate when the system is not operating properly. The TPMS malfunction indicator is combined with the low tire pressure telltale. When the system detects a malfunction, the telltale will flash for approximately one minute and then remain continuously illuminated. This sequence will continue upon subsequent vehicle start-ups as long as the malfunction exists. When the malfunction indicator is illuminated, the system may not be able to detect or signal low tire pressure as intended. TPMS malfunctions may occur for a variety of reasons, including the installation of replacement or alternate tires or wheels on the vehicle that prevent the TPMS from functioning properly. Always check the TPMS malfunction telltale after replacing one or more tires or wheels on your vehicle to ensure that the replacement or alternate tires and wheels allow the TPMS to continue to function properly.

## FTM Flat Tire Monitor

### The concept

The system detects a pressure loss on the basis of speed differences between the individual wheels while driving.

In the event of a pressure loss, the diameter and therefore the rotational speed of the corresponding wheel change. This is detected and reported as a flat tire.

The system does not measure the actual inflation pressure in the tires.

## Functional requirements

The system must have been initialized when the tire inflation pressure was correct; otherwise, reliable signaling of a flat tire is not ensured. Initialize the system after each correction of the tire inflation pressure and after every tire or wheel change.

## Status display

The current status of the Flat Tire Monitor can be displayed on the Control Display, e.g., whether or not the FTM is active.

1. "Vehicle Info"
2. "Vehicle status"
3.  "Flat Tire Monitor (FTM)"

The status is displayed.

## Initialization

The initialization process adopts the set inflation tire pressures as reference values for the detection of a flat tire. Initialization is started by confirming the inflation pressures.

Do not initialize the system when driving with snow chains.

1. "Vehicle Info"
2. "Vehicle status"
3.  "Perform reset"
4. Start the engine - do not drive away.
5. Start the initialization with "Perform reset".
6. Drive away.

The initialization is completed while driving, which can be interrupted at any time.

The initialization automatically continues when driving resumes.

## Indication of a flat tire



The yellow warning lamp lights up. A Check Control message is displayed.

There is a flat tire or a major loss in tire inflation pressure.

1. Reduce your speed and stop cautiously. Avoid sudden braking and steering maneuvers.
2. Check whether the vehicle is fitted with regular tires or run-flat tires.

Run-flat tires, refer to page 220, are labeled with a circular symbol containing the letters RSC marked on the tire sidewall.



Do not continue driving without run-flat tires

Do not continue driving if the vehicle is not equipped with run-flat tires; continued driving may result in serious accidents. ◀

When a flat tire is indicated, DSC Dynamic Stability Control is switched on if necessary.

## System limits



Sudden tire damage

Sudden serious tire damage caused by external influences cannot be indicated in advance. ◀

A natural, even pressure loss in all four tires cannot be detected. Therefore, check the tire inflation pressure regularly.

The system could be delayed or malfunction in the following situations:

- ▷ When the system has not been initialized.
- ▷ When driving on a snowy or slippery road surface.
- ▷ Sporty driving style: slip in the drive wheels, high lateral acceleration.
- ▷ When driving with snow chains.

## Actions in the event of a flat tire

### Normal tires

1. Identify the damaged tire.

Do this by checking the air pressure in all four tires.

If the tire inflation pressure in all four tires is correct, the Flat Tire Monitor may not have been initialized. In this case, initialize the system.

If an identification is not possible, please contact the service center.

2. Rectify the flat tire.

### Run-flat tires

#### Maximum speed

You can continue driving with a damaged tire at speeds up to 50 mph/80 km/h.

#### Continued driving with a flat tire

If continuing to drive with a damaged tire:

1. Avoid sudden braking and steering maneuvers.
2. Do not exceed a speed of 50 mph/80 km/h.
3. Check the air pressure in all four tires at the next opportunity.

If the tire inflation pressure in all four tires is correct, the Flat Tire Monitor may not have been initialized. In this case, initialize the system.

Possible driving distance with complete loss of tire inflation pressure:

The possible driving distance after a loss of tire inflation pressure depends on the cargo load and the driving style and conditions.

For a vehicle containing an average load, the possible driving distance is approx. 50 miles/80 km.

When the vehicle is driven with a damaged tire, its handling characteristics change, e.g., reduced lane stability during braking, a longer

braking distance, and altered self-steering properties. Adjust your driving style accordingly. Avoid abrupt steering maneuvers or driving over obstacles, e.g., curbs, potholes, etc.

Because the possible driving distance depends on how the vehicle is used during the trip, the actual distance may be smaller or greater depending on the driving speed, road conditions, external temperature, cargo load, etc.



#### Continued driving with a flat tire

Drive moderately and do not exceed a speed of 50 mph/80 km/h.

A loss of tire inflation pressure results in a change in the handling characteristics, e.g., reduced lane stability during braking, a longer braking distance and altered self-steering properties. ◀



#### Final tire failure

Vibrations or loud noises while driving can indicate the final failure of the tire. Reduce speed and stop; otherwise, pieces of the tire could come loose and cause an accident. Do not continue driving, and contact your service center. ◀

## Intelligent Safety

### The concept

Depending on how the vehicle is equipped, Intelligent Safety consists of one or more of the following systems, which can help to avoid an imminent collision.

- ▷ Collision warning, refer to page 113.
- ▷ Pedestrian warning, refer to page 119.
- ▷ Lane departure warning, refer to page 125.
- ▷ Active Blind Spot Detection, refer to page 126



## Note



Personal responsibility

The system does not serve as a substitute for the driver's personal judgment of the traffic situation.

Be aware of the traffic situation and the vehicle's surroundings at all times, otherwise an accident is still possible despite all warnings. ◀

## At a glance

### Button in the vehicle

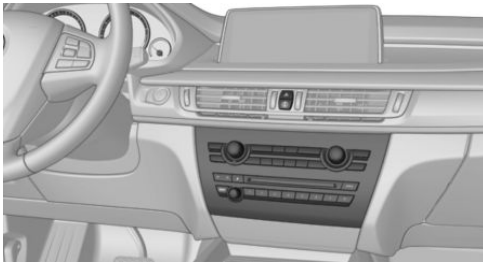

Intelligent Safety button

### Switching on/off

Some Intelligent Safety systems are automatically active after each engine start via the start/stop button. Some Intelligent Safety systems activate according to the last setting.



Press the button:

A panel appears on the Control Display. Adjustments can be made. The individual settings are stored for the remote control currently in use.



Press the button briefly:

- ▷ Intelligent Safety systems are individually switched off according to individual setting.
- ▷ LED lights up orange or goes out depending on the individual setting.

Press the button again:

- ▷ All Intelligent Safety systems are switched on.
- ▷ The LED lights up green.



Hold the button down:

- ▷ All Intelligent Safety systems are switched off.
- ▷ The LED goes out.

## Collision warning

Depending on how the equipment is equipped, the collision warning system consists of one of the following functions:

- ▷ Collision warning with City Braking function, refer to page [113](#).
- ▷ Collision warning with braking function, refer to page [116](#)

## Collision warning with City Braking function

### The concept

The system can help to prevent accidents. If an accident cannot be prevented, the system helps to reduce the collision speed.

The system issues a warning if there is imminent danger of a collision and if so brakes independently.

The automatic braking intervention is done with limited force and duration.

The system is controlled via a camera in the base of the mirror.

The collision warning is available even if cruise control has been deactivated.

When the vehicle is intentionally brought close to a vehicle, the collision warning is delayed to avoid false warnings.

## General information

The system issues a two-phase warning of a danger of collision with vehicles at speeds above approx. 3 mph/5 km/h. The time of these warnings may vary depending on the current driving situation.

Up to approx. 35 mph/60 km/h a braking intervention occurs when appropriate.

## Detection range

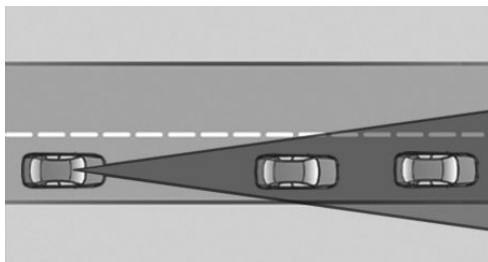

Vehicles are observed when they are traveling in the same direction of movement if they are located within the detection range of the system.

## At a glance

### Button in the vehicle

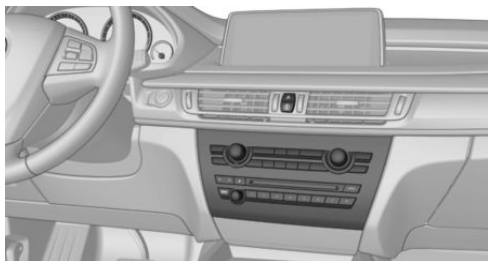

 Intelligent Safety button

## Camera

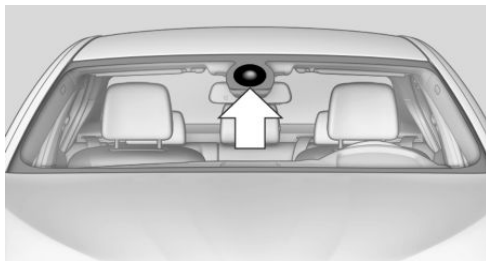

The camera is located near the base of the mirror.

Keep the windshield in the area behind the interior rear view mirror clean and clear.

## Switching on/off

### Switching on automatically

The system is automatically active every time the engine is started using the Start/Stop button.

### Switching on/off manually

 Press button: a panel appears on the Control Display. Adjustments can be made. The individual settings are stored for the remote control currently in use.

Press the button briefly:

- ▷ Intelligent Safety systems are individually switched off according to individual setting.
- ▷ The LED lights up orange.

Press the button again:

- ▷ All Intelligent Safety systems are switched on.
- ▷ The LED lights up green.

Hold the button down:

- ▷ All Intelligent Safety systems are switched off.
- ▷ The LED goes out.

## Setting the warning time

The warning time can be set via iDrive.

1. "Settings"
2. "Frontal Coll. Warning"
3. Activate the desired warning time on the Control Display.

If the vehicle is equipped with Night Vision with Dynamic Light Spot:

1. "Settings"
2. "Intelligent Safety"
3. "Frontal Coll. Warning"
4. Activate the desired warning time on the Control Display.

The selected channel is stored for the remote control currently in use.

## Warning with braking function

### Note

 Adapting your speed and driving style  
The warning does not relieve the driver of the responsibility to adapt his or her driving speed and style to the traffic conditions. ◀

### Display

If a collision with a vehicle detected in this way is imminent, a warning symbol appears on the instrument cluster and in the Head-up Display.

Symbol	Measure
	The vehicle lights up red: prewarning. Increase braking and distance.
	The vehicle flashes red and an acoustic signal sounds: acute warning. You are requested to intervene by braking or making an evasive maneuver.



The vehicle lights up red: prewarning.  
Increase braking and distance.



The vehicle flashes red and an acoustic signal sounds: acute warning.  
You are requested to intervene by braking or making an evasive maneuver.

## Braking intervention

The warning prompts the driver himself to intervene. During a warning, the maximum braking force is used. A prerequisite for the brake booster is a sufficiently fast and sufficiently strong actuation of the brake pedal. In addition, if there is a risk of collision, the system can assist with a slight braking intervention. The intervention can bring a vehicle traveling at slow speed to a complete stop.

The braking intervention is executed only if DSC Dynamic Stability Control is switched on and Dynamic Traction Control DTC is activated.

The braking intervention can be interrupted by pressing on the accelerator pedal or by actively moving the steering wheel.



### Tow-starting and towing

When tow-starting and towing the vehicle, switch off the Intelligent Safety systems; otherwise, improper behavior of the braking function of individual systems could result in an accident. ◀

## System limits



### Be alert

Due to system limitations, warnings may be not be issued at all, or may be issued late or improperly. Therefore, always be alert and ready to intervene; otherwise, there is the danger of an accident occurring. ◀

## Detection range

The system's detection capabilities are limited. This may result in the warning not being issued or being issued late.

For example, the following situations may not be detected:

- ▶ Slow moving vehicles when you approach them at high speed.
- ▶ Vehicles that suddenly swerve in front of you or sharply decelerating vehicles.

- ▷ Vehicles with an unusual rear appearance.
- ▷ Two-wheeled vehicles ahead of you.
- ▷ Pedestrians.

### Functional limitations

The system may not be fully functional in the following situations:

- ▷ In heavy fog, rain, sprayed water or snow-fall.
- ▷ In tight curves.
- ▷ If the driving stability control systems are limited or deactivated, for example, DSC OFF.
- ▷ If the camera in the mirror or the radar sensor is dirty or obscured.
- ▷ During calibration of the camera immediately after vehicle shipment.
- ▷ If there is constant dimming because of oncoming light, for example, from the sun low in the sky.

### Prewarning sensitivity

Depending on the set prewarning time, this may result in increased false warnings.

## Collision warning with braking function

### The concept

The system issues a warning if there is imminent danger of a collision and also includes a braking function.

If the vehicle is equipped with Active Cruise Control with Stop & Go, the collision warning is controlled via the cruise control radar sensor in conjunction with a camera.

The collision warning is available even if cruise control has been deactivated.

When the vehicle is intentionally brought close to a vehicle, the collision warning is delayed to avoid false warnings.

### General information

The system issues a two-phase warning of a possible danger of collision with vehicles at speeds above approx. 3 mph/5 km/h. The time of these warnings may vary depending on the current driving situation.

### Detection range

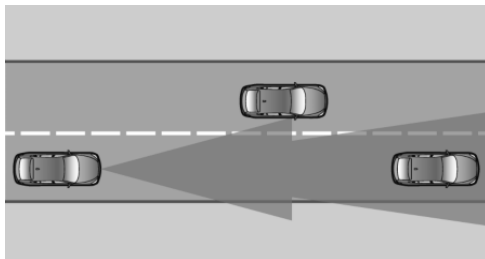

It responds to stationary or moving objects that are within the detection range of the radar system.

### At a glance

### Button in the vehicle

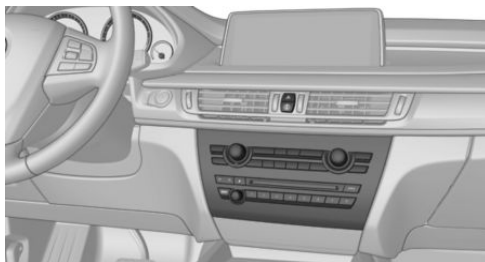

Intelligent Safety button

## Radar sensor

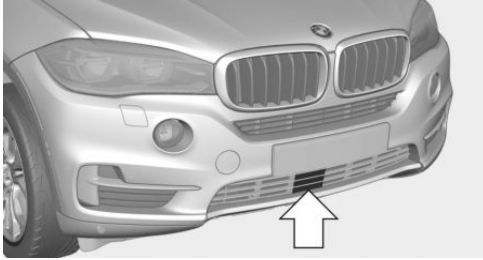

The radar sensor is located in the lower area of the front bumper.

Always keep radar sensor clean and unobstructed.

## Camera

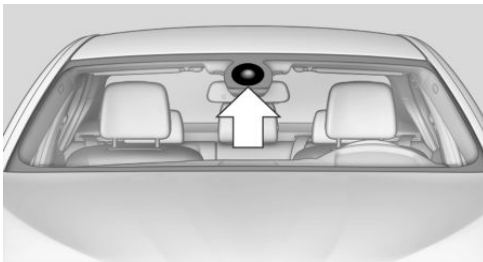

The camera is located near the base of the rear mirror.

Keep the windshield in the area behind the interior rear view mirror clean and clear.

## Switching on/off

### Switching on automatically

The system is automatically active every time the engine is started using the Start/Stop button.

### Switching on/off manually



Press button: a panel appears on the Control Display. Adjustments can be made. The individual settings are stored for the remote control currently in use.

Press the button briefly:

- ▷ Intelligent Safety systems are individually switched off according to individual setting.
- ▷ The LED lights up orange.

Press the button again:

- ▷ All Intelligent Safety systems are switched on.
- ▷ The LED lights up green.

Hold the button down:

- ▷ All Intelligent Safety systems are switched off.
- ▷ The LED goes out.

## Setting the warning time

The warning time can be set via iDrive.

1. "Settings"
2. "Frontal Coll. Warning"
3. Activate the desired warning time on the Control Display.

If the vehicle is equipped with Night Vision with Dynamic Light Spot:

1. "Settings"
2. "Intelligent Safety"
3. "Frontal Coll. Warning"
4. Activate the desired warning time on the Control Display.

The selected channel is stored for the remote control currently in use.

## Display

### Warning stages

#### Prewarning

This warning is issued, for example, when there is the impending danger of a collision or the distance to the vehicle ahead is too small.

## Acute warning with braking function

Warning of the imminent danger of a collision when the vehicle approaches another object at a relatively high differential speed.

The acute warning prompts the driver to intervene and, if there is the danger of a collision, is accompanied by a braking intervention.

The braking intervention may be executed with maximum braking force and for a brief period only as necessary.

The intervention can bring the vehicle to a complete stop.

The braking intervention is executed only if DSC Dynamic Stability Control is switched on and Dynamic Traction Control DTC is activated.

Above approx. 130 mph/210 km/h, the braking intervention occurs as a brief braking pressure. No automatic delay occurs.

 Adapting your speed and driving style

The warning does not relieve the driver of the responsibility to adapt his or her driving speed and style to the traffic conditions. ◀

The braking intervention can be interrupted by pressing on the accelerator pedal or by actively moving the steering wheel.



 Tow-starting and towing

When tow-starting and towing the vehicle, switch off the Intelligent Safety systems; otherwise, improper behavior of the braking function of individual systems could result in an accident. ◀

## Display in the instrument cluster

The collision warning can be issued in the instrument cluster, in the Head-up Display, and acoustically.

## Warning stages

Symbol	Measure
	The vehicle lights up red: prewarning. Increase distance.
	The vehicle flashes red and an acoustic signal sounds: acute warning. You are requested to intervene by braking or making an evasive maneuver.

 Adapting your speed and driving style  
The display does not relieve the driver of the responsibility to adapt his or her driving speed and style to the traffic conditions. ◀

## System limits

 Be alert  
Due to system limitations, warnings may be not be issued at all, or may be issued late or improperly. Therefore, always be alert and ready to intervene; otherwise, there is the danger of an accident occurring. ◀

## Detection range

The system's detection capabilities are limited. This may result in the warning not being issued or being issued late.

For example, the following situations may not be detected:

- ▷ Slow moving vehicles when you approach them at high speed.
- ▷ Vehicles that suddenly swerve in front of you or sharply decelerating vehicles.
- ▷ Vehicles with an unusual rear appearance.
- ▷ Two-wheeled vehicles ahead of you.
- ▷ Pedestrians.

## Functional limitations

The system may not be fully functional in the following situations:

- ▶ In heavy fog, rain, sprayed water or snow-fall.
- ▶ In tight curves.
- ▶ If the driving stability control systems are limited or deactivated, for example, DSC OFF.
- ▶ If the camera in the mirror or the radar sensor is dirty or obscured.
- ▶ During calibration of the camera immediately after vehicle shipment.
- ▶ If there is constant dimming because of oncoming light, for example, from the sun low in the sky.

## Prewarning sensitivity

Depending on the set prewarning time, this may result in increased false warnings.

## Pedestrian warning

Depending on how the vehicle is equipped, the function warns of an imminent collision with pedestrians during daytime or nighttime.

The function is subdivided into the following systems:

- ▶ During daytime: Pedestrian warning with city braking function, refer to page [119](#)
- ▶ At night: Night Vision with pedestrian detection, refer to page [121](#)

## Pedestrian warning with city braking function

### The concept

The system can help to prevent accidents with pedestrians.

The system issues a warning in the city driving speed area if there is imminent danger of a col-

lision with pedestrians and includes a braking function.

The system is controlled via the camera in the base of the interior mirror.

## General information

The system issues a warning with brightness starting at approx. 6 mph/10 km/h to approx. 35 mph/60 km/h regarding a possible risk of collision with pedestrians and assists with a brake intervention shortly before a collision.

It responds to persons that are within the detection range of the system.

## Detection range

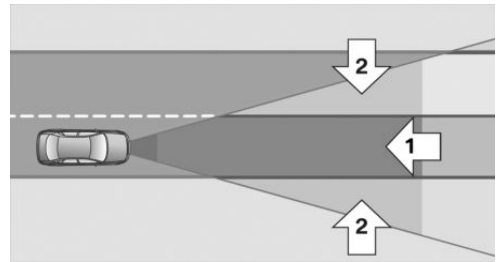

The detection area in front of the vehicle is divided into two areas.

- ▶ Central area, arrow 1, directly in front of the vehicle.
- ▶ Expanded area, arrow 2, to the right and left.

A collision is imminent if pedestrians are located within the central area. A warning is issued about pedestrians who are located within the extended area only if they are moving in the direction of the central area.

## At a glance

### Button in the vehicle

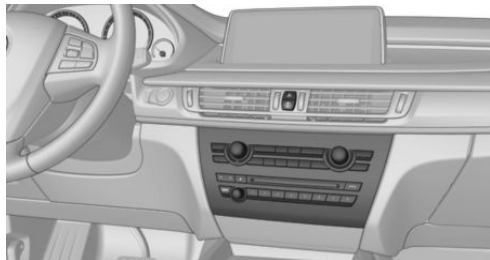

 Intelligent Safety button

### Camera

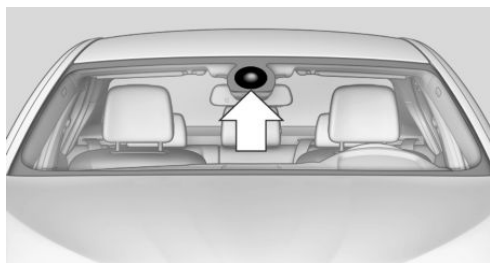

The camera is located near the base of the mirror.

Keep the windshield in the area behind the interior rear view mirror clean and clear.

## Switching on/off

### Switching on automatically

The system is automatically active every time the engine is started using the Start/Stop button.

### Switching on/off manually

 Press button: a panel appears on the Control Display. Adjustments can be made. The individual settings are stored for the remote control currently in use.

Press the button briefly:

- ▷ Intelligent Safety systems are individually switched off according to individual setting.

- ▷ The LED lights up orange.

Press the button again:

- ▷ All Intelligent Safety systems are switched on.

- ▷ The LED lights up green.

Hold the button down:

- ▷ All Intelligent Safety systems are switched off.

- ▷ The LED goes out.

## Warning with braking function

### Note

 Adapting your speed and driving style  
The warning does not relieve the driver of the responsibility to adapt his or her driving speed and style to the traffic conditions. ◀

### Display

If a collision with a person detected in this way is imminent, a warning symbol appears on the instrument cluster and in the Head-up Display.

 The red symbol is displayed and a signal sounds.

Intervene immediately by braking or making an evasive maneuver.

## Braking intervention

The warning prompts the driver himself to intervene. During a warning, the maximum braking force is used. A prerequisite for the brake booster is a sufficiently fast and sufficiently strong actuation of the brake pedal. In addition, if there is a risk of collision, the system can assist with a slight braking intervention. The intervention can bring a vehicle traveling at slow speed to a complete stop.



The braking intervention is executed only if DSC Dynamic Stability Control is switched on and Dynamic Traction Control DTC is activated.

The braking intervention can be interrupted by pressing on the accelerator pedal or by actively moving the steering wheel.

#### Tow-starting and towing

When tow-starting and towing the vehicle, switch off the Intelligent Safety systems; otherwise, improper behavior of the braking function of individual systems could result in an accident. ◀

### System limits

#### Be alert

Due to system limitations, warnings may be not be issued at all, or may be issued late or improperly. Therefore, always be alert and ready to intervene; otherwise, there is the danger of an accident occurring. ◀

### Detection range

The detection capability of the camera is limited.

This may result in the warning not being issued or being issued late.

For example, the following situations may not be detected:

- ▷ Partially covered pedestrians.
- ▷ Pedestrians that are not detected as such because of the viewing angle or contour.
- ▷ Pedestrians outside of the detection range.
- ▷ Pedestrians having a body size less than 32 in/80 cm.

### Functional limitations

The system may not be fully functional or may not be available in the following situations:

- ▷ In heavy fog, rain, sprayed water or snow-fall.

- ▷ In tight curves.
- ▷ If the camera view field or the front windshield are dirty or covered.
- ▷ When driving toward bright lights.
- ▷ Up to 10 seconds after the start of the engine, via the Start/Stop knob.
- ▷ During calibration of the camera immediately after vehicle shipment.
- ▷ When it is dark outside.

## Night Vision with Pedestrian and Animal Detection

### The concept

Night Vision with pedestrian and animal detection is a night vision system.

An infrared camera records the area in front of the vehicle and issues a warning if it detects pedestrians and animals on the street. Warm objects that are similar in shape to human beings or animals are detected by the system. If necessary, the heat image can be displayed on the Control Display.

### Heat image



The image shows the heat radiated by objects in the field of view of the camera.

Warm objects have a light appearance and cold objects, a dark appearance.

The ability to detect an object depends on the temperature difference between the object and the background and on the level of heat radiation emitted by the object. Objects that

are similar in temperature to the environment or that radiate very little heat are difficult to detect.

For safety reasons, when driving at speeds above approx. 3 mph/5 km/h and in low ambient light, the image is only displayed when the low beams are switched on.

A still image is displayed at regular intervals for a fraction of a second.

### Pedestrian and animal detection



Object detection and warning only functions in darkness.

Warm objects that are similar in shape to human beings are detected by the system.

In addition, the system also detects animals above a certain minimum size, e.g., deer.

With heat image activated on the Control Display:

People detected by the system are displayed with a slight yellow hue.

Animals detected by the system are displayed in a darker yellow.

Under good ambient conditions, the object detection operates within the following distance ranges:

- ▷ Pedestrian detection: up to approx. 330 ft/100 m
- ▷ Detection of large animals: up to approx. 490 ft/150 m
- ▷ Detection of medium animals: up to approx. 230 ft/70 m

Environmental influences can limit the availability of object detection.

If the vehicle systems detect that the vehicle is located in a residential area, the animal detection is temporarily switched off.

### Notes



#### Personal responsibility

Night Vision cannot replace the driver's personal judgment of the visibility conditions and the traffic situation. The view ahead and the actual visibility conditions must always be the basis on which the vehicle speed is adjusted; otherwise, there is a risk to road safety. ◀

### At a glance

#### Buttons in the vehicle

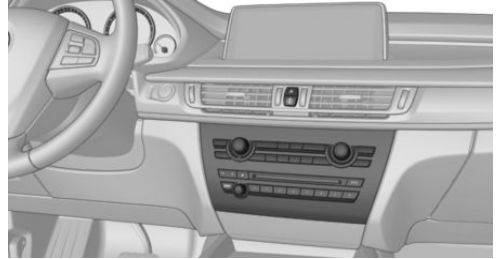

Intelligent Safety button



Switch on/switch off heat image

## Camera

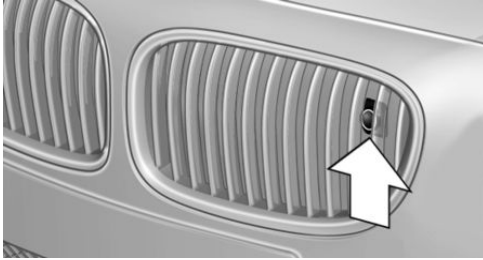

The camera is automatically heated when the external temperatures are low.

The camera is automatically cleaned together with the headlamps.

### Switching on/off

#### Switching on automatically

Every time the engine is started using the Start/Stop button, the system is automatically active at dark.

#### Switching on/off manually



Press button: a panel appears on the Control Display. Adjustments can be made. The individual settings are stored for the remote control currently in use.

Press the button briefly:

- ▶ Intelligent Safety systems are individually switched off according to individual setting.
- ▶ The LED lights up orange.

Press the button again:

- ▶ All Intelligent Safety systems are switched on.
- ▶ The LED lights up green.

Hold the button down:

- ▶ All Intelligent Safety systems are switched off.
- ▶ The LED goes out.

### Switching on heat image additionally

The heat image from the Night Vision camera can also be displayed on the Control Display. This function has no effect on object detection.



Press the button.

The image from the camera is displayed on the Control Display.

### Adjustments via the iDrive

With heat image switched on:

1. Press the controller.
2. Select brightness or contrast.
  - ▶ ☀ Select the symbol.
  - ▶ ● Select the symbol.
3. Turn the controller until the desired setting is reached, and press the controller.

## Display

### Warning of people or animals in danger

If a collision with a person or an animal detected in this way is imminent, a warning symbol appears on the instrument cluster and in the Head-up Display.

Although both the shape and the heat radiation are analyzed, false warnings cannot be ruled out.

## Warning area in front of the vehicle

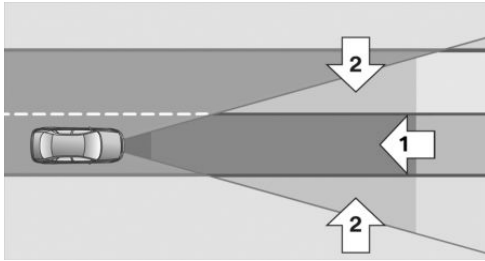

The warning area for the pedestrian warning consists of two parts:

- ▷ Central area, arrow 1, directly in front of the vehicle.
- ▷ Expanded area, arrow 2, to the right and left.

In the animal warning, no distinction is made between the central or expanded area.

The entire area moves along with the vehicle in the direction of the steering angle and changes with the vehicle speed. As the vehicle speed increases, the area becomes longer and wider, for example.

## Prewarning



The yellow symbol is displayed when a person is detected in the central area, arrow 1, immediately in front of the vehicle.

The yellow symbol is displayed when a person in the extended area, arrow 2, is moving from the right or left towards the central area.

The displayed symbol can vary with the people detected.

Intervene actively by braking or making an evasive maneuver.



When animals are detected, an animal symbol is displayed. The symbol also shows the side of the road on which the animal was detected. Intervene actively by braking or making an evasive maneuver.

## Acute warning



The red symbol is displayed and a signal sounds.

Intervene immediately by braking or making an evasive maneuver.

With animals no acute warning occurs.

## Display in the Head-up Display



The warning is displayed simultaneously in the Head-up Display and on the instrument cluster. The displayed symbol can vary with the people detected.

When animals are detected, an animal symbol is displayed.

## System limits

### Basic limits

System operation is limited in situations such as the following:

- ▷ On steep hills, in steep depressions or in tight curves.
- ▷ When the camera is dirty or the protective glass is damaged.
- ▷ In heavy fog, rain or snowfall.
- ▷ At very high external temperatures.

### Limits of pedestrian and animal detection

In some situations, it may occur that pedestrians are detected as animals or animals as pedestrians.

Small animals are not detected by the object detection function, even if they are clearly visible in the image.

Limited detection:

- ▷ People or animals who are fully or partially covered, especially when their heads are covered.
- ▷ People who are not in an upright position, e.g., lying down.

- Cyclists on unconventional bicycles (e.g., recumbent bicycles).
- After physical damage to the system, e.g., after an accident.

### No display on the rear screen

The image from Night Vision with people detection cannot be displayed on the rear screen.

## Lane departure warning

### The concept

Starting at a specific speed, this system alerts you when the vehicle on streets with lane markings is about to leave the lane. This speed, depending on the country version, is between 35 mph/55 km/h and 45 mph/70 km/h.

The steering wheel begins vibrating gently in the event of warnings. The time of the warning may vary depending on the current driving situation.

The system does not provide a warning if the turn signal is set before leaving the lane.

### Notes

 Personal responsibility

The system cannot serve as a substitute for the driver's personal judgment of the course of the road and the traffic situation.

In the event of a warning, do not jerk the steering wheel, as you may lose control of the vehicle. ◀

### At a glance

### Button in the vehicle

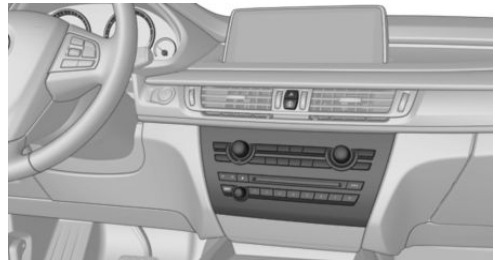

 Intelligent Safety button

### Camera

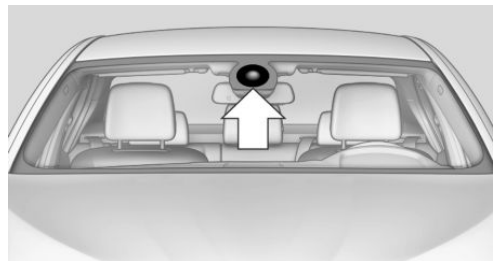

The camera is located near the base of the mirror.

Keep the windshield in the area behind the interior rear view mirror clean and clear.

### Switching on/off

#### Switching on automatically

The lane departure warning is automatically activated after the engine is started via the Start/Stop button, if the function was switched on the last time the engine was stopped.

#### Switching on/off manually

 Press button: a panel appears on the Control Display. Adjustments can be made. The individual settings are stored for the remote control currently in use.

Press the button briefly:

- ▷ Intelligent Safety systems are individually switched off according to individual setting.
- ▷ The LED lights up orange.

Press the button again:

- ▷ All Intelligent Safety systems are switched on.
- ▷ The LED lights up green.

Hold the button down:

- ▷ All Intelligent Safety systems are switched off.
- ▷ The LED goes out.

### Display in the instrument cluster



- ▷ Lines: system is activated.
- ▷ Arrows: at least one lane marking was detected and warnings can be issued.

### Issued warning

If you leave the lane and if a lane marking has been detected, the steering wheel begins vibrating.

If the turn signal is set before changing the lane, a warning is not issued.

### End of warning

The warning ends:

- ▷ Automatically after approx. 3 seconds.
- ▷ When returning to your own lane.
- ▷ When braking hard.
- ▷ When using the turn signal.

### System limits

The system may not be fully functional in the following situations:

- ▷ In heavy fog, rain or snowfall.

- ▷ In the event of worn, poorly visible, merging, diverging, or multiple lane markings such as in construction areas.
- ▷ When lane markings are covered in snow, ice, dirt or water.
- ▷ In tight curves or on narrow lanes.
- ▷ When the lane markings are covered by objects.
- ▷ When driving very close to the vehicle in front of you.
- ▷ When driving toward bright lights.
- ▷ When the windshield in front of the interior rearview mirror is fogged over, dirty or covered with stickers, etc.
- ▷ During calibration of the camera immediately after vehicle shipment.

## Active Blind Spot Detection

### The concept

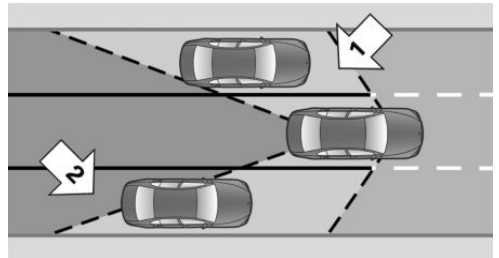

Two radar sensors below the rear bumper monitor the area behind and next to the vehicle at speeds above approx. 30 mph/50 km/h.

The system indicates whether there are vehicles in the blind spot, arrow 1, or approaching from behind on the adjacent lane, arrow 2.

The lamp in the exterior mirror housing lights up dimly.

Before you change lanes after setting the turn signal, the system issues a warning in the situations described above.

The lamp in the housing of the exterior mirror flashes and the steering wheel vibrates.

## Notes



Personal responsibility

The system does not serve as a substitute for the driver's personal judgment of the traffic situation.

Be aware of the traffic situation and the vehicle's surroundings at all times, otherwise an accident is still possible despite all warnings. ◀

## At a glance

### Button in the vehicle

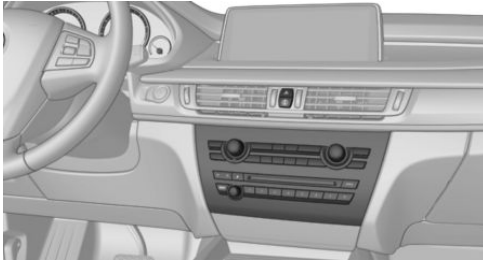

Intelligent Safety button

### Radar sensors



The radar sensors are located under the rear bumper.

## Switching on/off

### Switching on automatically

The Active Blind Spot Detection is automatically activated after the engine is started via the Start/Stop button, if the function was switched on the last time the engine was stopped.

### Switching on/off manually



Press button: a panel appears on the Control Display. Adjustments can be made. The individual settings are stored for the remote control currently in use.

Press the button briefly:

- ▷ Intelligent Safety systems are individually switched off according to individual setting.
- ▷ The LED lights up orange.

Press the button again:

- ▷ All Intelligent Safety systems are switched on.
- ▷ The LED lights up green.

Hold the button down:

- ▷ All Intelligent Safety systems are switched off.
- ▷ The LED goes out.

## Display

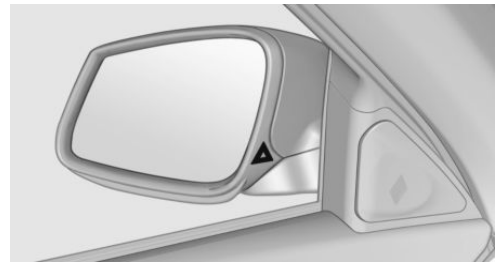

### Information stage

The dimmed lamp in the mirror housing indicates when there are vehicles in the blind spot or approaching from behind.

## Warning

If the turn signal is set while a vehicle is in the critical zone, the steering wheel vibrates briefly and the lamp in the mirror housing flashes brightly.

The warning stops when the turn signal is switched off, or the other vehicle leaves the critical zone.

## System limits

The system may not be fully functional in the following situations:

- ▷ When a vehicle is approaching at a speed much faster than your own.
- ▷ In heavy fog, rain or snowfall.
- ▷ In tight curves or on narrow lanes.
- ▷ If the bumper is dirty or iced up, or covered with stickers.

A Check Control message is displayed when the system is not fully functional.

## For US owners only

The transmitter and receiver units comply with part 15 of the FCC/Federal Communication Commission regulations. Operation is governed by the following:

FCC ID:

- ▷ NBG009014A.

Compliance statement:

This device complies with part 15 of the FCC Rules. Operation is subject to the following two conditions:

- ▷ This device may not cause harmful interference, and
- ▷ this device must accept any interference received, including interference that may cause undesired operation.

Any unauthorized modifications or changes to these devices could void the user's authority to operate this equipment.

## Brake force display

### The concept



- ▷ During normal brake application, the outer brake lamps light up.
- ▷ During heavy brake application, the inner brake lamps light up in addition.

## Active Protection

### General information

The Active Protection safety package consists of systems that are independent of each other:

- ▷ Attentiveness assistant.
- ▷ PreCrash
- ▷ PostCrash

### Attentiveness assistant

#### The concept

The system can detect increasing lack of alertness or fatigue of the driver during long, monotonous journeys, for example, on highways. In this situation, it is recommended that the driver take a break.

#### Note



Personal responsibility

The system cannot act as a substitute for the personal assessment of one's physical state and may not detect an increasing lack of alertness or fatigue or may not detect it cor-



rectly. Therefore, make sure that the driver is rested and alert; otherwise, risks may be detected too late and an accident be caused as a result. ◀

## Function

The system is activated each time the engine is started and cannot be switched off.

After travel has begun, the system is trained about the driver, so that increasing lack of alertness or fatigue can be detected.

This procedure takes the following criteria into account:

- ▷ Personal driving style, for example, steering behavior.
- ▷ Driving conditions, for example, length of trip.

Starting at approximately 43 mph/70 km/h, the system is active and can display a recommendation to take a break.

## Break recommendation

If the driver becomes increasingly less alert or fatigued, a message is displayed in the Control Display with the recommendation to take a break.

A recommendation to take a break is displayed only once during an uninterrupted trip.

After a break, another recommendation to take a break cannot be displayed until after approximately 45 minutes.

## System limits

The function may be limited in the following situations, for instance, and will either output an incorrect warning or no warning at all:

- ▷ When the clock is set incorrectly.
- ▷ When the vehicle speed is mainly below about 43 mph/70 km/h.
- ▷ With a sporty driving style, such as during rapid acceleration or when cornering quickly.

- ▷ In active driving situations, such as when changing lanes frequently.
- ▷ When the road surface is poor.
- ▷ In the event of strong side winds.

## PreCrash

### The concept

With this system critical driving situations that might result in an accident can be detected above a speed of approx. 20 mph/30 km/h. In these situations, preventative protection measures are automatically undertaken to minimize the risk in the event of an accident as much as possible.

Critical driving situations may include:

- ▷ Full brake applications.

If the vehicle includes the collision warning or collision warning with braking feature, impending collisions with vehicles driving ahead or stopped in front of you can also be detected within the system's range.

### Note



#### Personal responsibility

The system cannot possibly serve as a substitute for the driver's personal judgment of the traffic situation. The system may not always detect critical situations reliably and in a timely manner. Adapt speed to traffic situation and drive alertly; otherwise, a risk to safety may result. ◀

## Function

After the safety belt is buckled, the front belts are automatically pretensioned once after the vehicle is driven is away.

In critical driving situations, the following individual functions become active as needed:

- ▷ The front belts are automatically pretensioned.
- ▷ Automatic closing of the windows.

- ▷ Automatic closing of the glass sunroof.
- ▷ For vehicles equipped with Comfort Seats: automatic positioning of the backrest for the front passenger seat.

After a critical driving situation without an accident, the front belts are loosened again. All other systems can be restored to the desired setting.

If the belt tension does not loosen automatically, stop the vehicle and unbuckle the belt using the red button in the buckle. Fasten the belt before continuing on your trip.

## PostCrash

In the event of an accident, the system can bring the car to a halt automatically without intervention by the driver in certain situations. This can reduce the risk of a further collision and the consequences thereof.

Depressing the brake pedal can cause the vehicle to brake harder. This interrupts automatic braking. Depressing the accelerator pedal also interrupts automatic braking.

After coming to a halt, the brake is released automatically. Secure the vehicle against rolling.

# Driving stability control systems

## Vehicle equipment

All standard, country-specific and optional equipment that is offered in the model series is described in this chapter. Therefore, equipment is also described that is not available in a vehicle, e. g., because of the selected optional equipment or country variant. This also applies for safety-related functions and systems.

## Antilock Brake System ABS

ABS prevents locking of the wheels during braking.

The vehicle remains steerable even during full brake applications, thus increasing active safety.

ABS is operational every time you start the engine.

## Brake assistant

When you apply the brakes rapidly, this system automatically produces the maximum braking force boost. This then reduces braking distance to a minimum during full braking. This system utilizes all of the benefits provided by ABS.

Do not reduce the pressure on the brake pedal for the duration of the full braking.

When equipped with Driving Assistant Plus or with Active Cruise Control with Stop & Go function, ACC is supported by the braking intervention if there is a possible risk of collision. To do this, the braking force is automatically increased if the braking pressure is insufficient when the brakes are applied.

## Drive-off assistant

This system supports driving away on gradients. The parking brake is not required.

1. Hold the vehicle in place with the foot brake.
2. Release the foot brake and drive away without delay.

After the foot brake is released, the vehicle is held in place for approx. 2 seconds.

Depending on the vehicle load or when a trailer is being used, the vehicle may roll back slightly.



Driving off without delay

After releasing the foot brake, start driving without delay, since the drive-off assistant will not hold the vehicle in place for more than approx. 2 seconds and the vehicle will begin rolling back. ◀

## Automatic Differential Brake

The system controls the driving force by automatic braking intervention on individual wheels. The function corresponds to a differential lock: the system detects if a wheel begins to spin, because of loose road surface, for example, and automatically brakes it.

The driving force is diverted to the wheel with better traction.

As a result, the engine force is transferred more efficiently to the wheels during accelerations.

## Dynamic Performance Control

The Dynamic Performance Control increases both the agility of the vehicle as well as the lane stability.

The system seamlessly handles the distribution of the drive torque between the two rear wheels.

Depending on the situation, the drive torque is shifted from the wheel on the inside of the curve to the wheel on the outside of the curve or vice-versa.

To increase the maneuverability, the rear wheel on the outside of the curve is accelerated when the driving style is correspondingly sporty.

The steering responds directly; simultaneously, the understeering tendency of the four-wheel drive is canceled out.

With the oversteering tendency, the system exerts a stabilizing effect by accelerating the rear wheel on the inside of the curve.

The system noticeably improves the traction and simultaneously increases the driving safety, especially on road surfaces having fluctuating coefficients of friction.

## DSC Dynamic Stability Control

### The concept

DSC prevents traction loss in the driving wheels when driving away and accelerating.

DSC also recognizes unstable vehicle conditions, such as fishtailing or nose-diving. Subject to physical limits, DSC helps to keep the vehicle on a steady course by reducing engine speed and by applying brakes to the individual wheels.



Adjust your driving style to the situation

An appropriate driving style is always the responsibility of the driver.

The laws of physics cannot be repealed, even with DSC.

Therefore, do not reduce the additional safety margin by driving in a risky manner. ◀

### Indicator/warning lamps



The indicator lamp flashes: DSC controls the drive forces and brake forces.

The indicator lamp lights up: DSC has failed.

### Deactivating DSC: DSC OFF

When DSC is deactivated, driving stability is reduced during acceleration and when driving in bends.

To increase vehicle stability, activate DSC again as soon as possible.

### Deactivating DSC



Press and hold the button, but not longer than approx. 10 seconds, until the indicator lamp for DSC OFF lights up in the instrument cluster and DSC OFF is displayed.

The DSC system is switched off.

### Activating DSC



Press the button.

DSC OFF and the DSC OFF indicator lamp go out.

### Indicator/warning lamps

When DSC is deactivated, DSC OFF is displayed in the instrument cluster.



The indicator lamp lights up: DSC is deactivated.

## DTC Dynamic Traction Control

### The concept

The DTC system is a version of the DSC in which forward momentum is optimized.

The system ensures maximum forward momentum on special road conditions, e.g., unpolished snowy roads, but driving stability is limited.

It is therefore necessary to drive with appropriate caution.

You may find it useful to briefly activate DTC under the following special circumstances:

- ▶ When driving in slush or on uncleared, snow-covered roads.
- ▶ When rocking the vehicle or driving off in deep snow or on loose surfaces.
- ▶ When driving with snow chains.

### Deactivating/activating DTC Dynamic Traction Control

Activating the Dynamic Traction Control DTC provides maximum traction on loose ground. Driving stability is limited during acceleration and when driving in bends.

### Activating DTC



Press the button.

TRACTION is displayed in the instrument cluster and the indicator lamp for DSC OFF lights up.

### Deactivating DTC



Press the button again.

TRACTION and the DSC OFF indicator lamp go out.

### Indicator/warning lamps

When DTC is activated, TRACTION is displayed in the tachometer.



The indicator lamp lights up: DTC Dynamic Traction Control is activated.

## xDrive

xDrive is the all-wheel-drive system of your vehicle. Concerted action by the xDrive and DSC further optimize traction and driving dynamics. The xDrive all-wheel-drive system variably distributes the drive forces to the front and rear axles as demanded by the driving situation and road surface.

### Display on the Control Display

#### Displaying xDrive view

1. "Vehicle Info"
2. "xDrive status"
3.  "xDrive view"

The following information is displayed:

- ▶ With Professional navigation system: compass display for the driving direction
- ▶ Pitch attitude with degree and percentage
- ▶ Transverse gradient with degree indication
- ▶ Graphic display for the steering

#### Displaying distribution of the drive torque

1. "Vehicle Info"
2. "xDrive status"
3.  "Torque distribution"

## HDC Hill Descent Control

### The concept

HDC is a downhill driving assistant that automatically controls vehicle speed on steep downhill gradients. Without applying the brakes, the vehicle moves at slightly more than walking speed.

Hill Descent Control can be activated at speeds below approx. 22 mph/35 km/h. When driving downhill, the vehicle reduces its speed to approx. walking speed and then keeps its speed constant.

As long as there is active braking, the system is on standby. The system does not brake the vehicle during this time.

Use HDC in low gears or in transmission position D or R only.

### Increasing or decreasing vehicle speed

Specify desired speed in the range from approx. 4 mph/6 km/h to approx. 15 mph/25 km/h using the rocker switch of the cruise control on the steering wheel. Vehicle speed can be changed by lightly accelerating.

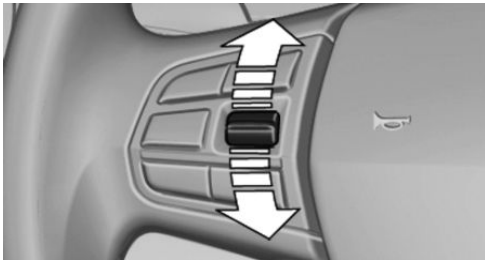

- ▷ Press up the rocker switch to the point of resistance: the speed increases gradually.
- ▷ Press up the rocker switch past the point of resistance: the speed increases while the rocker switch is pressed.
- ▷ Press down the rocker switch to the point of resistance: the speed decreases gradually.
- ▷ Press down the rocker switch past the point of resistance: when driving forward, the speed decreases to approx. 6 mph/10 km/h; when reversing, the speed decreases to approx. 4 mph/6 km/h.

### Activating HDC



-  Press the button; the LED above the button lights up.

### Deactivating HDC

-  Press the button again and the LED goes out. HDC is automatically deactivated above approx. 37 mph/60 km/h.

### Display in the instrument cluster



The selected speed is displayed in the speedometer.

- ▷ Green: the system is actively braking the vehicle.
- ▷ Orange: the system is on standby.

### Malfunction

A message is displayed in the instrument cluster. HDC is not available, e.g., due to elevated brake temperatures.

### Active Steering

Active Steering varies the steering angle of the wheels in relation to the steering wheel movement as a function of the speed.

At lower speeds, for example during turning or maneuvering, the steering angle is increased, that is to say the steering becomes more direct.

At higher speeds, the steering angle is increasingly reduced.

This enables even more precise handling at high speeds and more responsive steering with reduced steering angle at low speeds.

## Active roll stabilization

### The concept

The system reduces the lateral inclination of the vehicle that occurs during rapid driving in curves or during quick evasive maneuvers.

Driving stability and driving comfort are increased under all driving conditions. The system utilizes active stabilizer bars on the front and rear axles that react immediately to all driving situations.

### Programs

The system offers two different programs.

The programs can be selected via the Driving Dynamics Control, refer to page 135.

#### SPORT

Sporty tuning for greater driving agility.

#### COMFORT

Comfort-oriented tuning for optimal comfort.

## Vertical Dynamic Control

### The concept

This system reduces undesirable vehicle motion when using a dynamic driving style or traveling on uneven road surfaces.

The system enhances driving dynamics and comfort as required for the road surface and driving style.

### Programs

The system offers several different programs.

The programs can be selected via the Driving Dynamics Control, refer to page 135.

#### SPORT/SPORT+

Consistently sporty control of the shock absorbers for greater driving agility.

#### COMFORT/ECO PRO

Balanced tuning.

## Self-leveling suspension

### The concept

The self-leveling suspension keeps the vehicle height and ground clearance constant. The height of the vehicle at the rear axle is maintained at a predefined level under all load conditions.

The system ensures consistent comfort by keeping spring travel constant in all driving situations.

### Malfunction



A Check Control message is displayed. A malfunction has occurred in the self-leveling suspension. Vehicle handling may be altered and driving comfort may be noticeably reduced. Visit your nearest service center.

## Driving Dynamics Control

### The concept

The Driving Dynamics Control can be used to adjust the driving dynamics of the vehicle. For this purpose various programs are available for selection that are activated via the two buttons of the Driving Dynamics Control and the DSC OFF-button.

## Operating the programs

Press the button	Program
	DSC OFF TRACTION
	SPORT+ SPORT COMFORT ECO PRO

### Automatic program change

The system may automatically switch to COMFORT in the following situations:

- ▷ The vehicle has a flat tire.
- ▷ Failure of Dynamic Damping Control, Dynamic Drive or xDrive.

### DSC OFF

Driving stability is limited during acceleration and when driving in bends.

To increase vehicle stability, activate DSC again as soon as possible.

### Deactivating DSC: DSC OFF

 Press and hold the button, but not longer than approx. 10 seconds, until the indicator lamp for DSC OFF lights up in the instrument cluster and DSC OFF is displayed in the tachometer.

The DSC system is switched off.

### Activating DSC

 Press the button.  
DSC OFF and the DSC OFF indicator lamp go out.

### Indicator/warning lamps

When DSC OFF is activated, DSC OFF is displayed in the tachometer.



The indicator lamp lights up: DSC OFF is activated.

### TRACTION

Maximum traction on loose road surfaces. DTC Dynamic Traction Control is switched on. Driving stability is limited during acceleration and when driving in bends.

### Activating TRACTION



Press the button.

TRACTION is displayed in the tachometer.

The DSC indicator lamp in the instrument cluster lights up.

### Deactivating TRACTION



Press the button again.

TRACTION and the DSC indicator lamp go out.

### Indicator/warning lamps

When TRACTION is activated, TRACTION is displayed in the tachometer.



The indicator lamp lights up: TRACTION is activated.

### SPORT+

Sporty driving with optimized chassis and adapted engine control with limited driving stabilization.

Dynamic Traction Control is switched on.

The driver handles several of the stabilization tasks.

### Activating SPORT+



Press the button repeatedly until SPORT+ appears in the tachometer and the DSC OFF indicator lamp lights up in the instrument cluster.



## Automatic program change

When switching on the adjustable speed limit or activating cruise control, the program automatically switches to SPORT mode.

## Indicator/warning lamps

SPORT+ is displayed in the instrument cluster.



The DSC OFF indicator lamp lights up: Dynamic Traction Control is activated.

## SPORT

Consistently sporty tuning of the suspension and engine control for greater driving agility with maximum driving stabilization.

The program can be configured to individual specifications.

The configuration is stored for the remote control currently in use.

## Activating SPORT



Press the button repeatedly until SPORT appears in the tachometer.

## COMFORT

For a balanced tuning with maximum driving stabilization.

## Activating COMFORT



Press the button repeatedly until the program display in the tachometer goes out.

In certain situations, the system automatically changes to the NORMAL program, automatic program change, refer to page 136.

## ECO PRO

ECO PRO, refer to page 198, provides consistent tuning to minimize fuel consumption for maximum range with maximum driving stabilization.

Comfort functions and the engine controller are adjusted.

The program can be configured to individual specifications.

## Activating ECO PRO



Press button repeatedly until ECO PRO is displayed in the instrument cluster.

## Configuring ECO PRO

1. Activate ECO PRO.
2. "Configure ECO PRO"

Make the desired settings.

## Displays in the instrument cluster

### Selected program

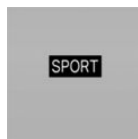

The selected program is displayed in the tachometer.

### Program selection

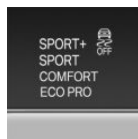

Pressing the button displays a list of the selectable programs.

## Display on the Control Display

Program changes can be displayed briefly on the Control Display.

To do so, make the following settings:

1. "Settings"
2. "Control display"
3. "Driving mode info"

# Driving comfort

## Vehicle equipment

All standard, country-specific and optional equipment that is offered in the model series is described in this chapter. Therefore, equipment is also described that is not available in a vehicle, e. g., because of the selected optional equipment or country variant. This also applies for safety-related functions and systems.

## Active Cruise Control with Stop & Go function, ACC

### The concept

This system can be used to select a desired speed that the vehicle will maintain automatically on clear roads.

To the extent possible, the system automatically adjusts the speed to a slower vehicle ahead of you.

The distance that the vehicle maintains to the vehicle ahead of you can be varied.

For safety reasons, it depends on the speed.

To maintain a certain distance, the system automatically reduces the speed, applies the brakes lightly, or accelerates again if the vehicle ahead begins moving faster.

If the vehicle ahead of you brakes to a halt, the system is able to detect this within the given system limits. If the vehicle ahead of your drives away again from a halt, your vehicle is able to accelerate if operated accordingly.

Even if some time passes before the vehicle ahead of you drives away again, your own vehicle can still be accelerated automatically and simply.

As soon as the road is clear, it accelerates to the desired speed.

The speed is also maintained on downhill gradients, but may not be maintained on uphill slopes if engine power is insufficient.

### General information

Depending on the set driving program, the characteristics of the cruise control can change in certain areas.

### Hints



#### Personal responsibility

Even an active system does not release the driver from personal responsibility for the driving process, especially for lane tracking, adaptation of speed, distance and driving style to the traffic conditions.

Because of technical system limits, the system cannot independently react appropriately in all traffic situations.

Monitor the driving process, the surrounding area and what is occurring in traffic continuously and attentively and actively intervene as required, e.g., by braking, steering or making an evasive maneuver. ◀











#### Unfavorable weather conditions

In the event of unfavorable weather and light conditions, e. g. if there is rain, snowfall, slush, fog or glare, this may result in poorer recognition of vehicles and lane limits as well as short-term interruptions for vehicles that are already detected. Drive attentively, and react to the current traffic events. Intervene actively when necessary, e.g., by braking, steering or making an evasive maneuver, otherwise, there is danger of an accident. ◀

## At a glance

### Buttons on the steering wheel

Press the button	Function
	Cruise control on/off, interrupting, refer to page 139
	Store/maintain speed, refer to page 140
	Resume speed, refer to page 141
	Reduce distance, refer to page 141
	Increase distance, refer to page 141
	With Congestion Assistant: Adjust distance, refer to page 141
	Rocker switch: Change/maintain speed, refer to page 140
	Congestion assistant: Congestion assistant on/off, interrupting, refer to page 145

The arrangement of the buttons varies according to the how the vehicle is equipped or country-specific variants.

### Radar sensor

A radar sensor is located in the front bumper for detecting vehicles on the road ahead of the vehicle.

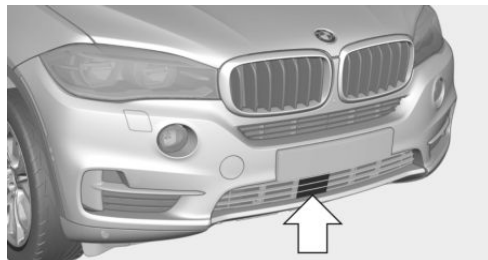

A dirty or covered sensor may hinder the detection of vehicles.

- ▷ If necessary, clean the radar sensor. Remove layers of snow and ice carefully.
- ▷ Do not cover the view field of the radar sensor.

### Camera

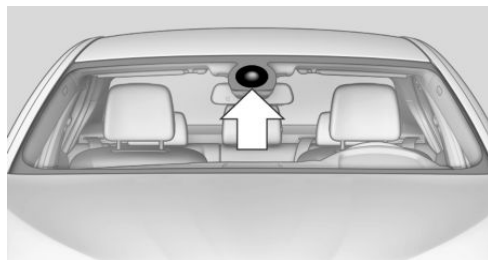

The camera is located near the base of the mirror.

Keep the windshield in the area behind the interior rearview mirror clean and clear.

A dirty or covered area in front of the interior mirror may hinder the detection of vehicles.

- ▷ If necessary, clean the area in front of the interior mirror, e.g., carefully remove salt residue in the winter.

### Switching on/off and interrupting cruise control

#### Switching on

 Press the button on the steering wheel.

The indicator lamps in the instrument cluster light up and the mark in the speedometer is set to the current speed.

Cruise control can be used.

## Switching off

 Deactivated or interrupted system  
If the system is deactivated or interrupted, actively intervene by braking, steering and, if necessary, with evasive maneuvers; otherwise, there is the danger of an accident occurring. ◀

If switching off the system while stationary, press on the brake pedal at the same time.

 Press the button on the steering wheel.

- ▷ If active: press twice.
- ▷ If interrupted: press once.

The displays go out. The stored desired speed and distance are deleted.

## Interrupting

 Press the button on the steering wheel.

If interrupting the system while stationary, press on the brake pedal at the same time.

The system is automatically interrupted in the following situations:

- ▷ When the brakes are applied.
- ▷ When transmission position D is disengaged.
- ▷ When DTC Dynamic Traction Control is activated or DSC is deactivated.
- ▷ When DSC is actively controlling stability.
- ▷ When SPORT+ is activated with Driving Dynamics Control.
- ▷ If the safety belt and the driver's door are opened when the vehicle is standing still.
- ▷ If the system has not detected objects for an extended period, e.g., on a road with

very little traffic without road edge line markings.

- ▷ If the detection range of the radar is disrupted, for example, by dirt or heavy fog.

## Maintaining/storing the speed

 Press the button.  
Or:

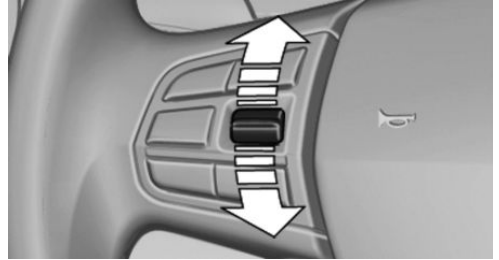

Press the rocker switch while the system is interrupted.

When the system is switched on, the current speed is maintained and stored as the desired speed.

This is displayed in the speedometer and briefly in the instrument cluster. Displays in the instrument cluster, refer to page 142.

When cruise control is maintained or stored, DSC Dynamic Stability Control is switched on, if necessary.

## Changing, maintaining, and storing the speed

The rocker switch can be pressed while the system is interrupted to maintain and store the current speed. DSC Dynamic Stability Control is switched on, if necessary.

 Adapting the desired speed  
Adapt the desired speed to the road conditions and be ready to brake at all times; otherwise, there is the danger of an accident occurring. ◀



### Speed differences

Large differences in speed relative to other vehicles cannot be compensated by the system for example in the following situations:

- ▷ When catching up rapidly with a truck.
- ▷ When another vehicle suddenly swerves into the wrong lane.
- ▷ When stationary objects are approached at speed. ◀

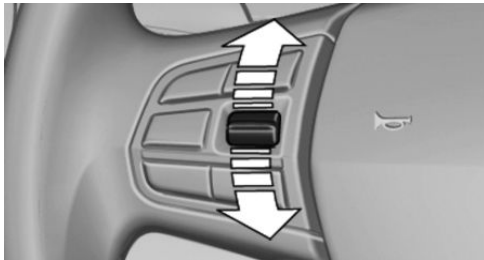

Press the rocker switch up or down repeatedly until the desired speed is set.

If active, the displayed speed is stored and the vehicle reaches the stored speed if the road is clear.

- ▷ Each time the rocker switch is pressed to the point of resistance, the desired speed increases or decreases by approx. 1 mph/1 km/h.
- ▷ Each time the rocker switch is pressed past the point of resistance, the desired speed increases or decreases by a maximum of 5 mph/10 km/h.

Hold the rocker switch in position to repeat the action.

## Distance



### Selecting a distance

Adjust the distance according to the traffic and weather conditions; otherwise, there is the danger of an accident occurring. Maintain the prescribed safety distance. ◀

## Reduce distance



Press the button repeatedly until the desired distance is set.

The selected distance, refer to page 142, is displayed in the instrument cluster.

## Increase distance



Press the button repeatedly until the desired distance is set.

The selected distance, refer to page 142, is displayed in the instrument cluster.

## With Congestion Assistant: adjust distance



Press the button repeatedly until the desired distance is set.

## Calling up the desired speed and distance

### While driving



Press the button with the system switched on.

In the following cases, the stored speed value is deleted and cannot be called up again:

- ▷ When the system is switched off.
- ▷ When the ignition is switched off.

### While standing



Before leaving the vehicle, secure it against rolling

Before leaving the vehicle with the engine running, engage position P of the automatic transmission and apply the parking brake. Otherwise, the vehicle may begin to roll. ◀

The system brought the vehicle to a complete standstill.

- ▷ Green marking in the speedometer:

Your vehicle accelerates automatically as soon as the vehicle in the range of the radar sensor moves off.

- ▶ Marking in the speedometer turns orange: no automatic driving away.

To accelerate to the desired speed automatically, press the accelerator or press the RES or SET button.

Rolling bars in the distance display indicate that the vehicle in the radar sensor detection range has moved off.

Your vehicle was braked to a halt by pressing on the brake pedal and it is standing behind another vehicle:

1.  Press the button to call up a stored desired speed.
2. Release the brake pedal.
3. Press on the accelerator briefly, or press the RES rocker switch when the vehicle ahead of you drives away.

## Displays in the instrument cluster

### Desired speed



- ▶ The marking lights up green: the system is active.
- ▶ The marking lights up orange: the system has been interrupted.

- ▶ The marking does not light up: the system is switched off.

### Brief status display

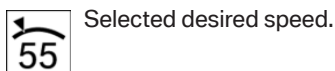

Selected desired speed.

If --- appears briefly on the display for Check Control messages, it is possible that the system requirements for operation are currently not met.

## Distance to vehicle ahead of you

The selected distance to the vehicle driving ahead of you is shown.

### Distance display



Distance 1



Distance 2



Distance 3



Distance 4

This value is set after the system is switched on.



The system has been interrupted or distance control is deactivated because the accelerator pedal is being pressed; a vehicle was not detected.



Distance control is deactivated because the accelerator pedal is being pressed; a vehicle was detected.

Rolling bars: the detected vehicle has driven away.

## Indicator/warning lamps



Personal responsibility

The indicator and warning lamps do not relieve the driver of the responsibility to adapt his or her desired driving speed and style to the traffic conditions. ◀



The vehicle symbol lights up orange:

A vehicle has been detected ahead of you.



The vehicle symbol flashes orange:

The conditions are not adequate for operating the system.

The system was deactivated but applies the brakes until you actively resume control by pressing on the brake pedal or accelerator pedal.



The vehicle symbol flashes red and an acoustic signal sounds:

You are requested to intervene by braking or making an evasive maneuver.

## Displays in the Head-up Display

The information from Active Cruise Control can also be displayed in the Head-up Display. Adjusting the Head-up Display, refer to page 97.

## System limits

### Speed range

Best results are achieved when using the system on well-developed roads and highways. The system is functional at speeds beginning at approx. 20 mph/30 km/h.

The maximum speed that can be set depends on the vehicle.

The system can also be activated when stationary.

Comply with the legal speed limit in every situation when using the system.

### Detection range

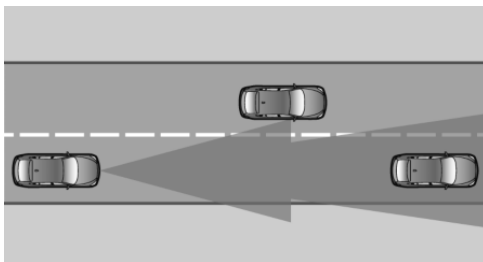

The detection capacity of the system and the automatic braking capacity are limited.

Two-wheeled vehicles for instance might not be detected.



### Limited detection capacity

Because of the limits to the detection capacity of the camera and the sensor, you should be alert at all times so that you can intervene actively, if necessary; otherwise, there is the danger of an accident occurring. ◀

## Deceleration

The system does not decelerate for:

- ▷ Pedestrians or similar slow-moving road users.
- ▷ Red traffic lights.
- ▷ Cross traffic.
- ▷ Oncoming traffic.

## Swerving vehicles

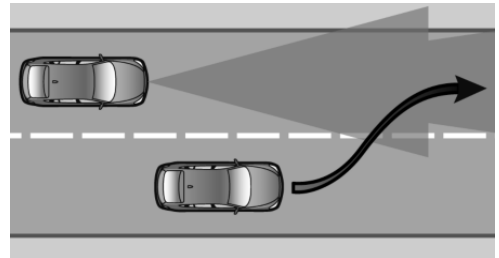

A vehicle driving in front of you is not detected until it is completely within the same lane as your vehicle.



### Swerving vehicles

If a vehicle driving ahead of you suddenly swerves into your lane, the system may not be able to automatically restore the selected distance. This also applies to major speed differences to vehicles driving ahead of you, e.g., when rapidly approaching a truck. When a vehicle driving ahead of you is reliably detected, the system requests that the driver intervene by braking and carrying out evasive maneuvers, if necessary. You must react yourself;

otherwise, there is the danger of an accident occurring. ◀

## Cornering

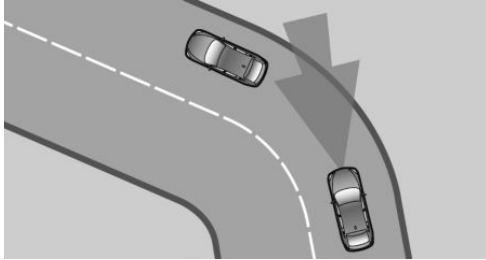

If the desired speed is too high for a curve, the speed is reduced slightly in the curve, although curves cannot be anticipated in advance. Therefore, drive into a curve at an appropriate speed.

In tight curves, situations may result due to the restricted detection range of the system in which a vehicle driving ahead of you may not be detected at all, or not until after a considerable delay.

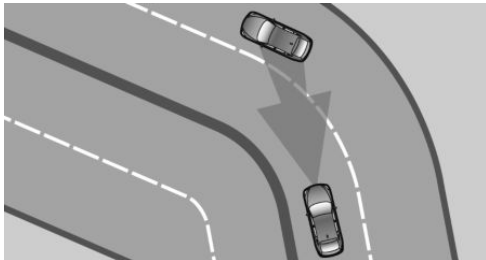

When approaching a curve, the system may react briefly to the vehicles in the next lane due to the bend of the curve. Any deceleration of the vehicle by the system can be compensated for by briefly accelerating. After the accelerator pedal is released, the system becomes active again and independently controls the speed.

## Driving away

In some situations, the vehicle cannot drive away automatically, e.g., on steep inclines or behind bumps in the road.

## Radar sensor

### For US owners only

The transmitter and receiver units comply with part 15 of the FCC/Federal Communication Commission regulations. Operation is governed by the following:

FCC ID:

- ▷ OAYARS3-A

Compliance statement:

This device complies with part 15 of the FCC Rules. Operation is subject to the following two conditions:

- ▷ This device may not cause harmful interference, and
- ▷ this device must accept any interference received, including interference that may cause undesired operation.

Any unauthorized modifications or changes to these devices could void the user's authority to operate this equipment.

### Malfunction

The system cannot be activated if the radar sensor is not aligned correctly. This may be caused by damage incurred during parking, for example.

A Check Control message is displayed if the system fails.

The function for detecting and responding when approaching stationary vehicles may be limited in the following situations:

- ▷ During calibration of the camera immediately after vehicle shipment.
- ▷ If the camera is malfunctioning or dirty. A Check Control message is displayed.



## Congestion Assistant

### The concept

In congestion situations, the system controls the speed, steers independently as required and keeps the vehicle close to the center of the lane.

To the extent possible, the system automatically adjusts the speed to a slower vehicle ahead of you. The distance that the vehicle maintains to the vehicle ahead of you can be varied. For safety reasons, it depends on the speed. To maintain a certain distance, the system automatically reduces the speed, applies the brakes lightly, or accelerates again if the vehicle ahead begins moving faster.

When lane markings are detected, the system keeps the vehicle in the center of the lane. For this purpose, the system steers independently as needed, for example, during cornering.

### General information

The congestion assistant determines speed and distance from the vehicle in front and the position of the lane markings via a radar sensor and a camera.

Sensors on the steering wheel detect whether the steering wheel is being touched.

The system is deactivated as soon as the steering wheel is no longer being touched.

In order to be able to use the Congestion Assistant, place your hands around the steering wheel.

When driving with gloves or with protective covers, contact with the steering wheel cannot be detected by the sensors. The system in this case cannot be used.

### Hints



#### Personal responsibility

Even an active system does not release the driver from personal responsibility for the driving process, especially for lane tracking,

adaptation of speed, distance and driving style to the traffic conditions.

Because of technical system limits, the system cannot independently react appropriately in all traffic situations.

Monitor the driving process, the surrounding area and what is occurring in traffic continuously and attentively and actively intervene as required, e.g., by braking, steering or making an evasive maneuver. ◀



#### Unfavorable weather conditions





In the event of unfavorable weather and light conditions, e. g. if there is rain, snowfall, slush, fog or glare, this may result in poorer recognition of vehicles and lane limits as well as short-term interruptions for vehicles that are already detected. Drive attentively, and react to the current traffic events. Intervene actively when necessary, e.g., by braking, steering or making an evasive maneuver, otherwise, there is danger of an accident. ◀

### Functional requirements

- ▷ Drive on approved road type. The data on this are stored in the navigation system. Approved road types are highways.
- ▷ Sufficient lane width.
- ▷ Lane marking on both sides is detected.
- ▷ Vehicle driving ahead is detected.
- ▷ Speed below 25 mph/40 km/h.
- ▷ Both hands on the steering wheel rim.
- ▷ Sufficient curvature.
- ▷ Drive in the center of the lane.

## At a glance

### Buttons on the steering wheel

Press the button	Function
	Congestion Assistant ON/OFF, Pause, refer to page 146.
	Rocker switch: Store, change/maintain speed, refer to page 140.
	Maintain, store speed, refer to page 140.
	Resume speed, refer to page 141.
	Adjust distance, refer to page 141.

### Radar sensor

A radar sensor is located in the front bumper for detecting vehicles on the road ahead of the vehicle.

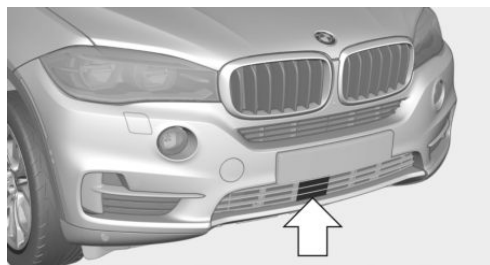

A dirty or covered sensor may hinder the detection of vehicles.

- ▷ If necessary, clean the radar sensor. Remove layers of snow and ice carefully.
- ▷ Do not cover the view field of the radar sensor.

### Camera

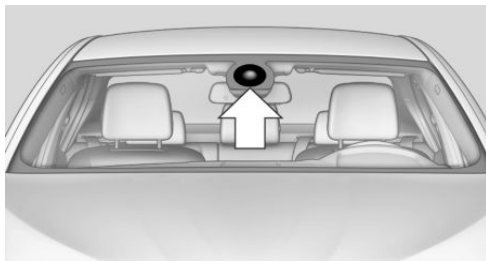

The camera is located near the base of the mirror.

Keep the windshield in the area behind the interior rearview mirror clean and clear.

A dirty or covered area in front of the interior mirror may hinder the detection of vehicles.

- ▷ If necessary, clean the area in front of the interior mirror, e.g., carefully remove salt residue in the winter.

### Switching on/off and pausing

#### Switching on



Press the button.

- ▷ Prepare system: press once.
- ▷ Activate system:
  - If the ACC is not activated: press rocker.
  - With ACC activated: system is ready.
  - Drive in the center of the lane.
  - The system is automatically activated below 25 mph/40 km/h.



If ACC is not activated: indicator lamp in the instrument cluster comes on.



If ACC is not activated: indicator lamp in the instrument cluster comes on.

Congestion Assistant can be used.

With Congestion Assistant switched on, the Pedestrian Warning system is active. The setting in the Control Display is unchanged.

## Switching off

 Deactivated or interrupted system

If the system is deactivated or interrupted, actively intervene by braking, steering and, if necessary, with evasive maneuvers; otherwise, there is the danger of an accident occurring. ◀

 Press the button.

The indicator goes out. Stored desired speed and distance are still kept by the ACC.

The system does not carry out a steering movement.

## Interrupting

 When active, press the button.

The system is automatically interrupted in the following situations:

- ▶ At a speed above 25 mph/40 km/h.
- ▶ With only one detected lane marking.
- ▶ When you leave the limited access highway.
- ▶ When the steering wheel is released.
- ▶ When you intervene in the steering.
- ▶ When you leave your own lane.
- ▶ When there is no vehicle ahead.
- ▶ When the turn signal is on.
- ▶ When the lane is too narrow.

 Rolling bars:  
Congestion assistant is no longer accelerating. To accelerate further, activate ACC by briefly pressing the accelerator, pressing the RES button or rocker switch.

 Red flashing and signal tone:  
Congestion Assistant is interrupted.  
The system does not carry out a steering movement. ACC exercises control.

If the system conditions are met, the system reactivates automatically.

When you leave the approved road type, the system is first interrupted and then shuts down.

## Distance

 Selecting a distance

Adjust the distance according to the traffic and weather conditions; otherwise, there is the danger of an accident occurring. Maintain the prescribed safety distance. ◀

## Adjust distance

 Press the button repeatedly until the desired distance is set.

## Distance to vehicle ahead of you

The selected distance to the vehicle driving ahead of you is shown.

### Distance display

 Distance 1

 Distance 2





 Distance 3

 Distance 4  
This value is set after the system is switched on.

 Selecting a distance

Adjust the distance according to the traffic and weather conditions; otherwise, there is the danger of an accident occurring. Maintain the prescribed safety distance. ◀

## Displays in the instrument cluster

Symbol	Description
	Congestion Assistant and Distance Control on standby.
	Congestion Assistant on standby. Distance control controls within the set distance.
	Congestion Assistant activated. The system controls the speed and assists with maintaining the lane.
	Rolling bars: speed is no longer increased by the congestion assistant at 25 mph/40 km/h. When the speed is increased by the driver, the system does not perform any more steering movements.
	Red flashing and signal tone: congestion Assistant is interrupted. The system does not carry out a steering movement. ACC exercises control.

## System limits

When driving within narrow driving lanes, e.g., in construction zones or rescue lanes, the system cannot be activated or meaningfully used.

 **Limited detection capacity**  
Because of the limits to the detection capacity of the camera and the sensor, you should be alert at all times so that you can intervene actively, if necessary; otherwise, there is the danger of an accident occurring.◀

 **Complying with country-specific laws**  
When the Congestion Assistant is used, observe specific national laws.◀

## Cruise control

### The concept

The system is functional at speeds beginning at approx. 20 mph/30 km/h.

It maintains the speed that was set using the control elements on the steering wheel.

The system brakes on downhill gradients if engine braking action is insufficient.

 **Unfavorable conditions**  
Do not use the system if unfavorable conditions make it impossible to drive at a constant speed, for instance:

- ▷ On curvy roads.
- ▷ In heavy traffic.
- ▷ On slippery roads, in fog, snow or rain, or on a loose road surface.





Otherwise, you could lose control of the vehicle and cause an accident.◀

### General information

Depending on the set driving program, the characteristics of the cruise control can change in certain areas.

### Controls

#### At a glance

Press the button	Function
	Cruise control on/off, interrupting, refer to page 149
	Store/maintain speed, refer to page 149
	Resume speed, refer to page 150
	Rocker switch: Change/maintain speed, refer to page 149

The arrangement of the buttons varies according to the how the vehicle is equipped or country-specific variants.

### Switching on

 Press the button on the steering wheel.

The marking in the speedometer is set to the current speed.

The cruise control can be used.

### Switching off

 Deactivated or interrupted system

If the system is deactivated or interrupted, actively intervene by braking and, if necessary, with evasive maneuvers; otherwise, there is the danger of an accident occurring. ◀

 Press the button on the steering wheel.

- ▷ If active: press twice.
- ▷ If interrupted: press once.

The displays go out. The stored desired speed is deleted.

### Interrupting

 When active, press the button.

The system is automatically interrupted if:

- ▷ The brakes are applied.
- ▷ The transmission position D is disengaged.
- ▷ DTC Dynamic Traction Control is activated or DSC is deactivated.
- ▷ DSC is actively controlling stability.
- ▷ HDC is activated.
- ▷ When SPORT+ is activated with Driving Dynamics Control.

### Maintaining/storing the current speed

 Press the button.

Or:

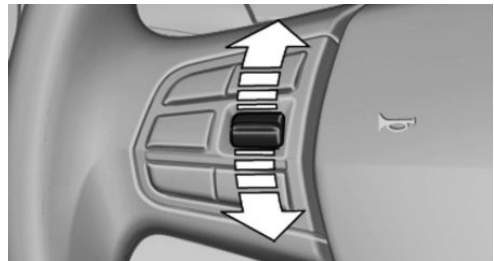

Press the rocker switch while the system is interrupted.

When the system is switched on, the current speed is maintained and stored as the desired speed.

It is displayed in the speedometer and briefly displayed in the instrument cluster. Displays in the speedometer, refer to page 150.

When cruise control is maintained or stored, DSC Dynamic Stability Control is switched on, if necessary.

### Changing/maintaining speed

The rocker switch can be pressed while the system is interrupted in order to maintain and store the current speed.

 Adapting the desired speed

Adapt the desired speed to the road conditions and be ready to brake at all times; otherwise, there is the danger of an accident occurring. ◀

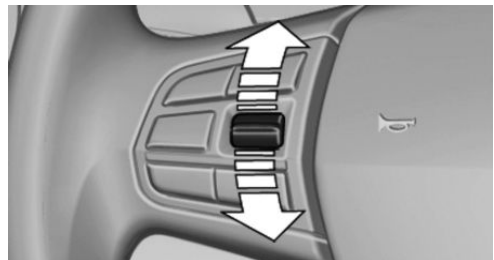

Press the rocker switch up or down repeatedly until the desired speed is set.

If active, the displayed speed is stored and the vehicle reaches the stored speed if the road is clear.

- ▷ Each time the rocker switch is pressed to the point of resistance, the desired speed increases or decreases by approx. 1 mph/1 km/h.
- ▷ Each time the rocker switch is pressed past the point of resistance, the desired speed increases or decreases by a maximum of 5 mph/10 km/h.  
The maximum speed that can be set depends on the vehicle.
- ▷ Pressing the rocker switch to the resistance point and holding it accelerates or decelerates the vehicle without requiring pressure on the accelerator pedal. After the rocker switch is released, the vehicle maintains its final speed. Pressing the switch beyond the resistance point causes the vehicle to accelerate more rapidly.

### Resuming the desired speed



Press the button.

The stored speed is reached and maintained.

### Displays in the instrument cluster

#### Indicator lamp



Depending on how the vehicle is equipped, the indicator lamp in the instrument cluster indicates whether the system is switched on.

#### Desired speed



- ▷ The marking lights up green: the system is active.
- ▷ The marking lights up orange: the system has been interrupted.

- ▷ The marking does not light up: the system is switched off.

### Brief status display



Selected desired speed.

If --- appears briefly on the display for Check Control messages, it is possible that the system requirements for operation are currently not met.

## PDC Park Distance Control

### The concept

PDC supports you when parking. Objects that you are approaching slowly in front of or behind your vehicle are indicated by:

- ▷ Signal tones.
- ▷ Visual display.

### General information

Measurements are made by ultrasound sensors in the bumpers.

The range, depending on the environment, is approx. 6 ft/2 m.

An acoustic warning is first given:

- ▷ By the front sensors and the two rear corner sensors at approx. 24 in/60 cm.
- ▷ By the rear middle sensors at approx. 5 ft/1.50 m.

To ensure full operability:

- ▷ Do not cover sensors, e.g., by stickers, bicycle racks and the like.
- ▷ Keep the sensors clean and free of ice.
- ▷ When using high-pressure washers, do not spray the sensors for long periods and maintain a distance of at least 12 in/30 cm.

## Hints



### Personal responsibility

Even an active system does not relieve the driver from personal responsibility for the driving process.

Because of technical system limits, the system cannot independently react appropriately in all traffic situations.

Continuously and attentively monitor the driving process, the area surrounding the vehicle and the traffic situation, and actively intervene when required, otherwise, there is a risk of an accident. ◀



### Avoid driving quickly with PDC

Avoid approaching an object quickly.

Avoid driving away quickly while PDC is not yet active.

For technical reasons, the system may otherwise be too late in issuing a warning. ◀

## At a glance

### Button in the vehicle



### PDC Park Distance Control

## Switching on/off

### Switching on automatically

PDC switches on automatically in the following situations:

- ▶ If the engine is running, select transmission position R.

- ▶ If, with the appropriate equipment, obstacles are detected behind or in front of the vehicle by PDC and the speed is slower than approx. 2 mph/3 km/h.

Automatic activation when obstacles are detected can be switched off:

1. "Settings"
2. "Parking"
3. Select the setting.

The setting is stored for the remote control currently in use.

### Automatic deactivation during forward travel

The system switches off when a certain driving distance or speed is exceeded.

Switch the system back on if necessary.

### Switching on/off manually



Press the button.

- ▶ On: the LED lights up.
- ▶ Off: the LED goes out.

In addition to the PDC Park Distance Control, the rearview camera, refer to page 153, can be switched on.

### Switching on the rearview camera via the iDrive

With PDC activated or Top View switched on:

 "Rear view camera"

The rearview camera image is displayed. The setting is stored for the remote control currently in use.

## Display

### Signal tones

When approaching an object, an intermittent tone is sounded that indicates the position of the object. For example, if an object is de-

tected to the left rear of the vehicle, a signal tone sounds from the left rear speaker.

The shorter the distance to the object becomes, the shorter the intervals.

If the distance to a detected object is less than approx. 10 in/25 cm, a continuous tone is sounded.

If objects are located both in front of and behind the vehicle, an alternating continuous signal is sounded.

The signal tone is switched off:

- ▷ When the vehicle moves away from an object by more than approx. 4 in/10 cm.
- ▷ When transmission position P is engaged.

## Volume

The volume of the PDC signal can be adjusted, refer to user's manual for Navigation, Entertainment, Communication.

The setting is stored for the remote control currently in use.

## Visual warning

The approach of the vehicle to an object can be shown on the Control Display. Objects that are farther away are displayed on the Control Display before a signal tone sounds.

A display appears as soon as Park Distance Control (PDC) is activated.

The range of the sensors is represented in the colors red, green and yellow.

If the rearview camera image was selected last, it again appears on the display. To switch to PDC:

1.  "Rear view camera" Select the symbol on the Control Display.
2. Press the controller.

The setting is stored for the remote control currently in use.

## System limits

### Limits of ultrasonic measurement

The detection of objects can reach the physical limits of ultrasonic measurement, e.g., in the following circumstances:

- ▷ For small children and animals.
- ▷ For persons with certain clothing, e.g. coats.
- ▷ If there is an external disturbance of the ultrasound, e.g. from passing vehicles or loud machines.
- ▷ When sensors are soiled, iced over or damaged.
- ▷ Under certain weather conditions, e.g., high relative humidity, rain, snowfall or strong wind.
- ▷ With tow bars and trailer hitches of other vehicles.
- ▷ With thin or wedge-shaped objects.
- ▷ With moving objects.
- ▷ With elevated, protruding objects such as ledges or cargo.
- ▷ With objects with corners and sharp edges.
- ▷ With objects with a fine surface structure, such as fences.
- ▷ For objects with porous surfaces.

Low objects already displayed, e.g., curbs, can move into the blind area of the sensors before or after a continuous tone sounds.

### False warnings

PDC may issue a warning under the following conditions even though there is no obstacle within the detection range:

- ▷ In heavy rain.
- ▷ When sensors are very dirty or covered in ice.
- ▷ When sensors are covered in snow.
- ▷ On rough road surfaces.



- On uneven surfaces, such as speed bumps.
- In large buildings with right angles and smooth walls, e.g., in underground garages.
- In heavy exhaust.
- Due to other ultrasound sources, e.g., sweeping machines, high pressure steam cleaners or neon lights.

## Malfunction

A Check Control message is displayed.

The range of the sensors is shown as a shaded area on the Control Display.

PDC has failed. Have the system checked.

To ensure full operability:

- Keep the sensors clean and free of ice.
- When using high-pressure washers, do not spray the sensors for long periods and maintain a distance of at least 12 in/30 cm.

## Surround View

### The concept

Surround View comprises various camera assistance systems that help the driver when parking, maneuvering, and at complex exits and intersections.

- Rearview camera, refer to page [153](#)
- Top View, refer to page [156](#).
- Panorama Side View, refer to page [158](#).

## Backup camera

### The concept

The rearview camera provides assistance in parking and maneuvering backwards. The area behind the vehicle is shown on the Control Display.

## Hints



Check the traffic situation as well

Check the traffic situation around the vehicle with your own eyes. Otherwise, an accident could result from road users or objects located outside the picture area of the backup camera. ◀

## At a glance

### Button in the vehicle



Rearview camera

### Camera

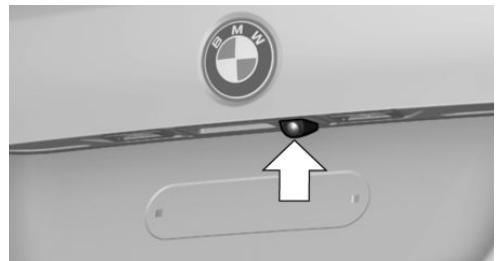

The camera lens is located in the handle of the tailgate. The image quality may be impaired by dirt.

Clean the lens, refer to page [247](#).

### Switching on/off

### Switching on automatically

Select transmission position R with the engine running.

The rearview camera image is displayed if the system was switched on via the iDrive.

### Automatic deactivation during forward travel

The system switches off when a certain driving distance or speed is exceeded.

Switch the system back on if necessary.

### Switching on/off manually



Press the button.

- ▷ On: the LED lights up.
- ▷ Off: the LED goes out.

The PDC is shown on the Control Display.

### Switching on the rearview camera via the iDrive

With PDC activated or Top View switched on:

 "Rear view camera"

The rearview camera image is displayed. The setting is stored for the remote control currently in use.

### Display on the Control Display

#### Functional requirement

- ▷ The rearview camera is switched on.
- ▷ The tailgate is fully closed.

#### Activating the assistance functions

More than one assistance function can be active at the same time.

- ▷ Parking aid lines

 "Parking aid lines"

Pathway and turning circle lines are displayed.

- ▷ Obstacle marking

 "Obstacle marking"

Spatially-shaped markings are displayed.

### Pathway lines

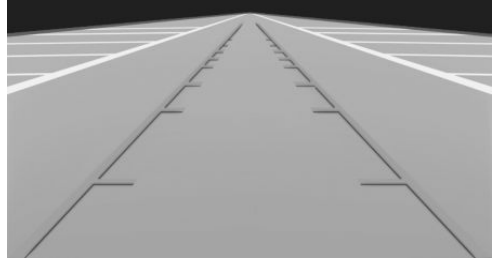

- ▷ Can be shown in the rearview camera image.
- ▷ Help you to estimate the space required when parking and maneuvering on level roads.
- ▷ Are dependent on the current steering angle and are continuously adjusted to the steering wheel movements.

### Turning circle lines

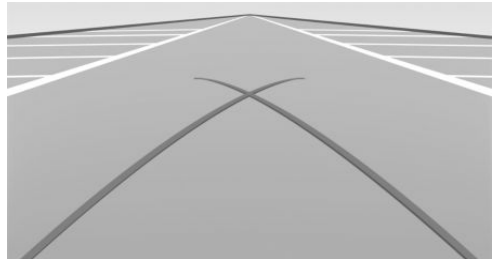

- ▷ Can be shown in the rearview camera image.
- ▷ Show the course of the smallest possible turning circle on a level road.
- ▷ Only one turning circle line is displayed after the steering wheel is turned past a certain angle.

## Obstacle marking

### General information

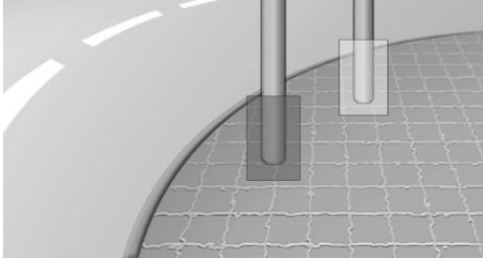

Obstacles behind the vehicle are detected by the PDC sensors and, when appropriately equipped, detected by the rearview camera.

Marks for detected obstacles can be shown in the rearview camera image.

Their colored steps match the markings of the PDC. This simplifies estimation of the distance to the object shown.

### Parking using pathway and turning circle lines

1. Position the vehicle so that the turning circle lines lead to within the limits of the parking space.

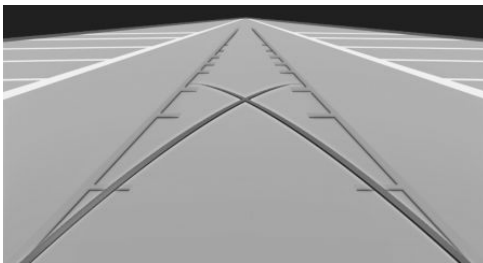

2. Turn the steering wheel to the point where the pathway line covers the corresponding turning circle line.

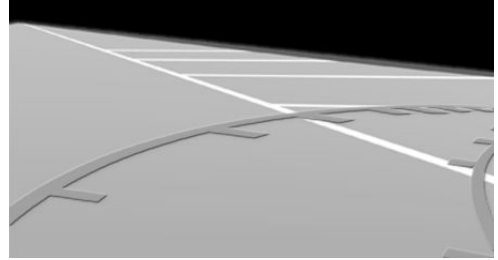

### Display settings

#### Brightness

With the rearview camera switched on:

1. ☀ Select the symbol.
2. Turn the controller until the desired setting is reached, and press the controller.

#### Contrast

With the rearview camera switched on:

1. ● Select the symbol.
2. Turn the controller until the desired setting is reached, and press the controller.

### System limits

#### Detection of objects

Very low obstacles as well as high, protruding objects such as ledges may not be detected by the system.

Assistance functions also take into account data of the PDC.

Follow instructions in the PDC chapter, refer to page 150.

The objects displayed in the Control Display under certain circumstances are closer than they appear. Therefore, do not estimate the distance from the objects on the display.

## Top View

### The concept

Top View provides assistance in parking and maneuvering. The area around the vehicle is shown on the Control Display.

### General information

The image is captured by two cameras integrated in the exterior mirrors, by the rear-view camera and a camera on the front of the vehicle.

The range is no more than approx. 6.5 ft/2 m to the side, front and rear.

Obstacles within this range are thus displayed early on the Control Display.

### Notes



Check the traffic situation as well

Check the traffic situation around the vehicle with your own eyes. Otherwise, an accident could result from road users or objects located outside the picture area of the cameras. ◀

### At a glance

#### Button in the vehicle



Top View

## Cameras

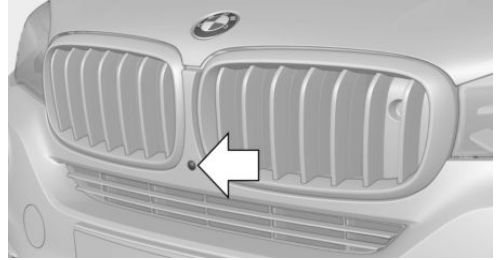

Front camera

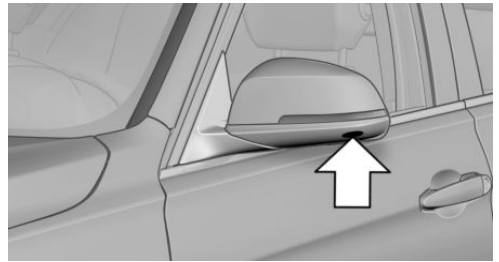

The lenses of the Top View cameras are located at the bottom of the exterior mirror housings. The image quality may be impaired by dirt.

Clean the lens, refer to page [247](#).

### Functional requirements

Top View can be used only to a limited extent in the following situations:

- ▷ With a door open.
- ▷ With the tailgate open.
- ▷ With an exterior mirror folded in.
- ▷ In poor light.

The unavailable camera range is depicted with cross-hatching.

### Switching on/off

#### Switching on automatically

Select drive mode R with the engine running.

The Top View and PDC images are displayed if the system is switched on via iDrive.

### Automatic deactivation during forward travel

The system switches off when a certain driving distance or speed is exceeded.

Switch the system back on if necessary.

### Switching on/off manually



Press the button.

- ▷ On: the LED lights up.
- ▷ Off: the LED goes out.

Top View is displayed.

### Switching on the backup camera via the iDrive

With Top View switched on:

 "Rear view camera"

The backup camera image is displayed. The setting is stored for the remote control currently in use.

## Display

### Display on the Control Display

The area surrounding the vehicle can be displayed on the Control Display.

The display appears as soon as Top View is activated.

If the rearview camera image was selected last, it again appears on the display when reverse gear is selected. To switch to Top View:

 "Rear view camera" Select the symbol on the Control Display.

The setting is stored for the remote control currently in use.

## Brightness

With Top View switched on:

1.  Select the symbol.
2. Turn the controller until the desired setting is reached, and press the controller.

## Contrast

With Top View switched on:

1.  Select the symbol.
2. Turn the controller until the desired setting is reached, and press the controller.

## Displaying the turning circle and pathway lines

- ▷ The static, red turning circle line shows the space needed to the side of the vehicle when the steering wheel is turned all the way.
- ▷ The variable, green pathway line assists you in assessing the amount of space actually needed to the side of the vehicle.
  - The lane line depends on the engaged drive mode and the current steering angle.
  - The track line is continuously adjusted for the steering wheel movement.

 "Parking aid lines"

Turning circle and pathway lines are displayed.

## System limits

A Check Control message is displayed when a camera is defective.

## Panorama Side View

### The concept

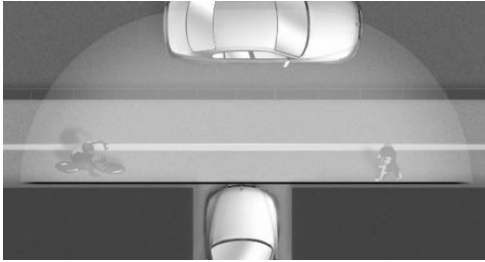

Panorama Side View provides an early look at cross traffic at blind driveways and intersections. Road users concealed by obstacles to the left and right of the vehicle can only be detected relatively late from the driver's seat. To improve the viewing, each camera, front and rear on the vehicle, detects the traffic area on the side.

Which camera is active is shown on the top edge of the screen.

### Hints

The images of the cameras are displayed, depending on the gear selected, on the Control Display.



Check the traffic situation as well

Check the traffic situation around the vehicle on blind driveways and intersections with your own eyes. Otherwise, an accident could result from road users or objects located outside the picture areas of the Panorama Side View cameras. ◀

### At a glance

### Button in the vehicle



 Panorama Side View

### Cameras

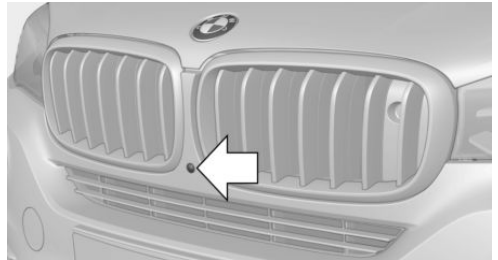

Front camera

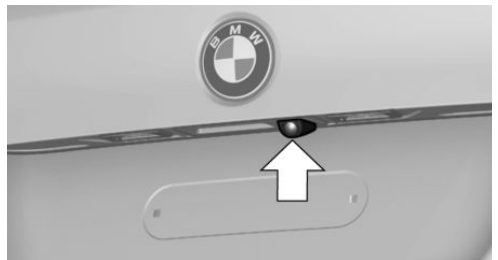

Rear camera

Two cameras are used for the detection.

The image quality may be impaired by dirt.

Clean the lens, refer to page [247](#).

## Switching on/off

### Switching on/off manually



Press the button.

Depending on the transmission position, the picture of the front or rear camera is displayed.

### Switching off automatically

By switching into a different function or during drive mode change.

Front Panorama Side View: when a certain driving distance or speed is exceeded.

## Display

### General information

The traffic area in front of or behind the vehicle is displayed on the Control Display.

### Brightness

With Panorama Side View switched on:

1. ☀ Select the symbol.
2. Turn the controller until the desired setting is reached, and press the controller.

### Contrast

With Panorama Side View switched on:

1. 🕒 Select the symbol.
2. Turn the controller until the desired setting is reached, and press the controller.

## Warning of crossing traffic

### The concept

If an object approaching from the side is detected by the front or rear camera, this is depicted by a symbol in the Panorama Side View display.

### Requirements

- ▶ Panorama Side View switched on.

- ▶ Your vehicle moves no faster than walking speed.
- ▶ To detect approaching objects, sufficient brightness, for example, daylight is necessary.

## Display



The yellow symbol is displayed if an approaching vehicle is detected by the camera.



A gray symbol is displayed if the detection of crossing traffic is not possible.

## System limits

In the following situations, the warning about crossing traffic may be limited:

- ▶ In poor lighting or visibility conditions.
- ▶ If the camera is soiled or covered.

## System limits

The objects displayed in the Control Display under certain circumstances are closer than they appear. Therefore, do not estimate the distance from the objects on the display.

The viewing angle is approx. 180°.

## Parking assistant

### The concept

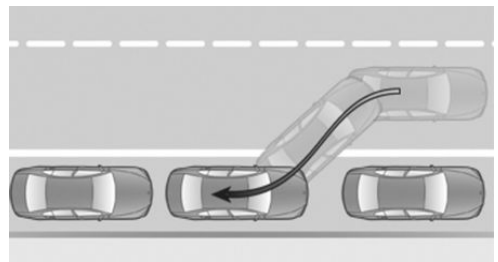

This system assists the driver in parking parallel to the road.

Ultrasound sensors measure parking spaces on both sides of the vehicle.

The parking assistant calculates the best possible parking line and during the parking procedure takes control of steering, the acceleration and braking and if necessary changes the drive modes. Hold down the parking assistant button for the duration of the parking operation. At the end of the parking procedure, the P selector lever position is engaged.

When parking, also take note of the visual and acoustic information and instructions issued by the PDC, the parking assistant and the rear-view camera and react accordingly.

A component of the parking assistant is the PDC Park Distance Control, refer to page 150.

## Hints

### Personal responsibility

Even an active system does not relieve the driver from personal responsibility for the driving process.

Because of technical system limits, the system cannot independently react appropriately in all traffic situations.

Continuously and attentively monitor the driving process, the area surrounding the vehicle and the traffic situation, and actively intervene when required, otherwise, there is a risk of an accident. ◀

### Changes to the parking space

Changes to the parking space after it was measured are not taken into account by the system.

Therefore, always be alert and ready to intervene; otherwise, there is the danger of an accident occurring. ◀

### Transporting loads

Loads that extend beyond the perimeter of the vehicle are not taken into account by the system during the parking procedure.

Therefore, always be alert and ready to intervene; otherwise, there is the danger of an accident occurring. ◀

### Curbs

The parking assistant may steer the vehicle over or onto curbs.

Therefore, always be alert and ready to intervene; otherwise, the wheels, tires, or the vehicle may become damaged. ◀

An engine that has been switched off by the Auto Start Stop function is restarted automatically when the parking assistant is activated.

## Requirements

### For measuring parking spaces

- ▶ Maximum speed while driving forward approx. 22 mph/35 km/h.
- ▶ Maximum distance to row of parked vehicles: 5 ft/1.5 m.

### Suitable parking space

- ▶ Gap between two objects with a minimum length of approx. 5 ft/1.5 m.
- ▶ Minimum length of the gap: own vehicle's length plus approx. 4 ft/1.2 m.
- ▶ Minimum depth: approx. 5 ft/1.5 m.

### For parking procedure

- ▶ Doors and tailgate closed.
- ▶ Parking brake released.



## At a glance

### Button in the vehicle



 Parking assistant

### Ultrasound sensors

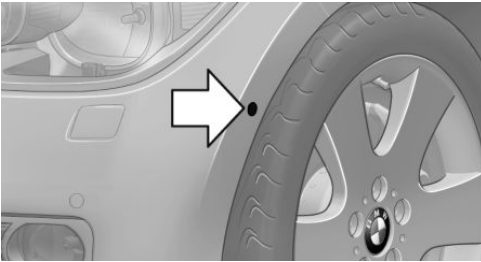

The ultrasound sensors for measuring parking spaces are located on the wheel arches.

To ensure full operability:

- ▷ Keep the sensors clean and free of ice.
- ▷ When using high-pressure washers, do not spray the sensors for long periods and maintain a distance of at least 12 in/30 cm.

## Switching on/off

### Switching on with the button

-  Press the button.
- The LED lights up.

The current status of the parking space search is indicated on the Control Display.

 Parking assistant is activated automatically.

## Switching on with the reverse gear

Shift into reverse.

The current status of the parking space search is indicated on the Control Display.

Activate:  "Parking Assistant" Select the symbol in the Control Display.



## Switching off

The system can be deactivated as follows:

- ▷  Press the button.
- ▷ Switch off the ignition.

## Display on the Control Display

### System activated/deactivated

Symbol	Meaning
	Gray: the system is not available. White: the system is available but not activated.
	The system is activated.

## Status display

Depending on the appointment version, different views of the status display are shown and are described below as View 1, refer to page 161, or View 2, refer to page 162.

### Status of the system, Display 1

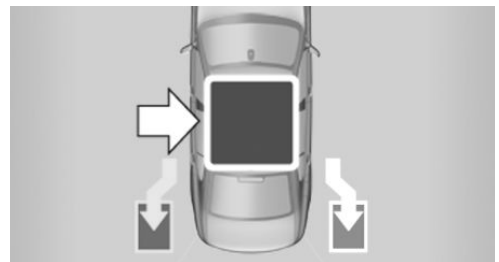

The status is displayed with symbols.



Gray: parking space search.  
Blue: the system is activated. A suitable parking space was found.



The parking procedure is active.  
Steering control has been seized.

### Status of the parking space search

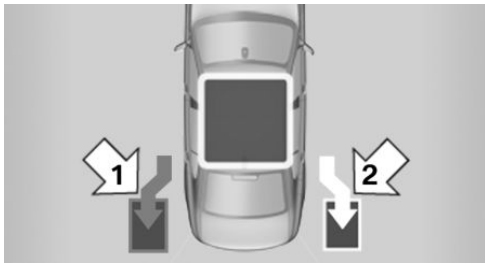

- ▷ Gray, arrow 1: parking space search.
- ▷ Blue, arrow 2: parking space is suitable.  
The vehicle is parked in the parking space if the parking procedure is active.
- ▷ No display: no parking space search.

### Status of the system, Display 2

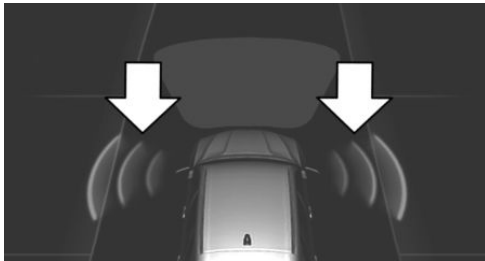

- ▷ Colored symbols, see arrows, on the side of the vehicle representation. Parking assistant is activated and search for parking space active.
- ▷ Suitable parking spaces are displayed next to the vehicle symbol at the edge of the

road as on the Control Display. When the parking assistant is active, suitable parking spaces are highlighted.

- ▷  The parking procedure is active. Steering control has been seized.

- ▷ Parking space search is always active whenever the vehicle is moving forwards slow and straight, even if the system is deactivated. When the system is deactivated, the displays on the Control Display are shown in gray.

### Parking using the parking assistant



Check the traffic situation as well



Loud sounds outside and within the vehicle can drown out the signal tones of the parking assistant and PDC.

Check the traffic situation around the vehicle with your own eyes; otherwise, there is the danger of an accident. ◀

1. Switch on the parking assistant and activate it if necessary.  
The status of the parking space search is indicated on the Control Display.
2. Follow the instructions on the Control Display.  
The end of the parking procedure is indicated on the Control Display.
3. Adjust the parking position yourself if necessary.

### Interrupting manually

The parking assistant can be interrupted at any time:

- ▷  "Parking Assistant" Select the symbol on the Control Display.
- ▷  Press the button.

## Interrupting automatically

The system is interrupted automatically in the following situations:

- ▷ When the button is released.
- ▷ If the driver grasps the steering wheel or if he takes over steering.
- ▷ If a gear is selected that does not match the instruction on the Control Display.
- ▷ During acceleration.
- ▷ When setting the parking brake.
- ▷ If a turn signal is activated in the opposite direction to the desired side for parking.
- ▷ If the vehicle speed exceeds approx. 6 mph/10 km/h.
- ▷ On snow-covered or slippery road surfaces if necessary.
- ▷ If doors are open.
- ▷ If the tailgate is open.
- ▷ When there are obstacles that are hard to overcome, such as curbs.
- ▷ When there are obstacles that suddenly arise.
- ▷ If a maximum number of parking attempts or the time taken for parking is exceeded.

A Check Control message is displayed.

## Continuing

An interrupted parking procedure can be continued if necessary.

Follow the instructions on the Control Display to do this.

## System limits

### No parking assistance

The parking assistant does not offer assistance in the following situations:

- ▷ In tight curves.

## Functional limitations

The system may not be fully functional in the following situations:

- ▷ On bumpy road surfaces such as gravel roads.
- ▷ On slippery ground.
- ▷ On steep uphill or downhill grades.
- ▷ When leaves or snow has collected in the parking space.

## Limits of ultrasonic measurement

The detection of objects can reach the physical limits of ultrasonic measurement, e.g., in the following circumstances:

- ▷ For small children and animals.
- ▷ For persons with certain clothing, e.g. coats.
- ▷ If there is an external disturbance of the ultrasound, e.g. from passing vehicles or loud machines.
- ▷ When sensors are soiled, iced over or damaged.
- ▷ Under certain weather conditions, e.g., high relative humidity, rain, snowfall or strong wind.
- ▷ With tow bars and trailer hitches of other vehicles.
- ▷ With thin or wedge-shaped objects.
- ▷ With moving objects.
- ▷ With elevated, protruding objects such as ledges or cargo.
- ▷ With objects with corners and sharp edges.
- ▷ With objects with a fine surface structure, such as fences.
- ▷ For objects with porous surfaces.

Low objects already displayed, e.g., curbs, can move into the blind area of the sensors before or after a continuous tone sounds.

The parking assistant may identify parking spaces that are not suitable for parking.

## Malfunction

A Check Control message is displayed.

The parking assistant failed. Have the system checked.

## Distance information

### The concept

The system displays a symbol in the Head-up Display to indicate that the distance behind the vehicle in front is not sufficient.

### General information

The distance is determined by the radar sensor of the Active Cruise Control.

### Hints



Personal responsibility

The display does not relieve the driver of the responsibility to adapt his or her distance and driving style to the traffic conditions. Maintain the prescribed safety distance. ◀

### At a glance

#### Radar sensor

A radar sensor is located in the front bumper for detecting vehicles on the road ahead of the vehicle.

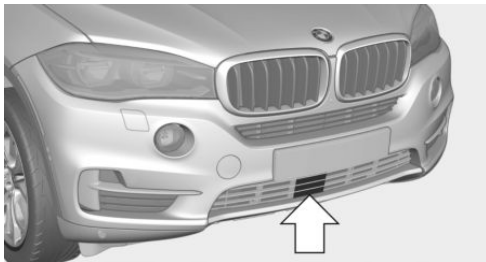

A dirty or covered sensor may hinder the detection of vehicles.

- ▷ If necessary, clean the radar sensor. Remove layers of snow and ice carefully.
- ▷ Do not cover the view field of the radar sensor.

### Switching on

1. Switching on Head-Up Display, refer to page 97.
2. "Distance info": Select the indication in the Head-Up Display, refer to page 97.

### Display in the Head-up Display



The symbol is displayed when the distance from the vehicle traveling ahead is too short.

### Functional requirements

- ▷ Active Cruise Control switched off.
- ▷ Display in the Head-up Display selected.
- ▷ Distance too short.
- ▷ Speed greater than approx. 40 mph/70 km/h.

### Malfunction

The system cannot be activated if the radar sensor is not aligned correctly. This may be caused by damage incurred during parking, for example.

A Check Control message is displayed if the system fails.

# Climate control

## Vehicle equipment

All standard, country-specific and optional equipment that is offered in the model series is described in this chapter. Therefore, equip-

ment is also described that is not available in a vehicle, e. g., because of the selected optional equipment or country variant. This also applies for safety-related functions and systems.

## Automatic climate control

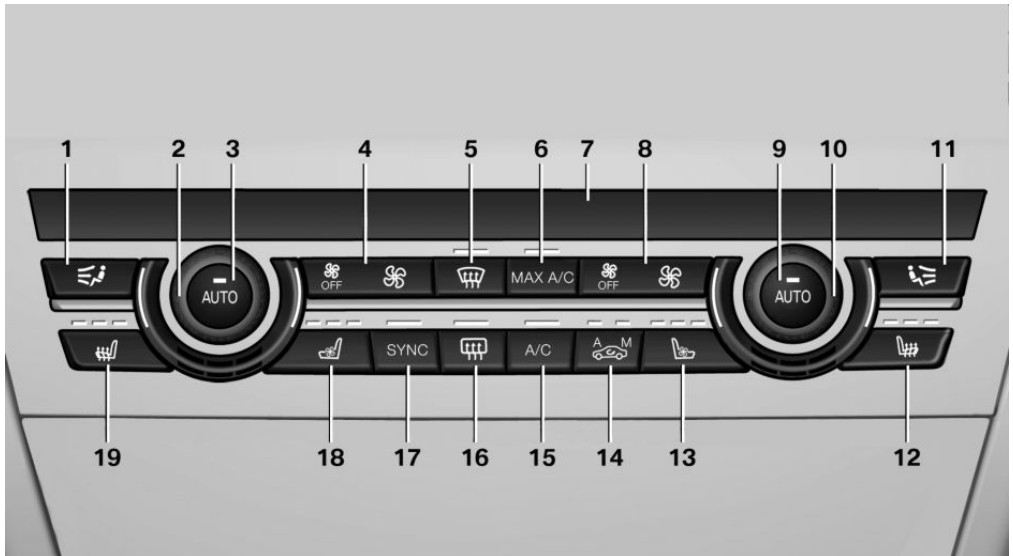

- |   |   |
|---|---|
| 1 Air distribution, left                        | 11 Air distribution, right                                  |
| 2 Temperature, left                             | 12 Seat heating, right <a href="#">53</a>                   |
| 3 AUTO program, left                            | 13 Active seat ventilation, right <a href="#">53</a>        |
| 4 Air flow, AUTO intensity, left, residual heat | 14 Automatic recirculated-air control/recirculated-air mode |
| 5 Remove ice and condensation                   | 15 Cooling function   |
| 6 Maximum cooling                               | 16 Rear window defroster                                    |
| 7 Display                                       | 17 SYNC program   |
| 8 Air volume, AUTO intensity, right             | 18 Active seat ventilation, left <a href="#">53</a>         |
| 9 AUTO program, right                           | 19 Seat heating, left <a href="#">53</a>                    |
| 10 Temperature, right                           |   |

## Climate control functions in detail

### Manual air distribution



Press the button repeatedly to select a program:

- ▷ Upper body region.
- ▷ Upper body region and footwell.
- ▷ Footwell.
- ▷ Windows and footwell.
- ▷ Windows, upper body region, and footwell.
- ▷ Windows: driver's side only.
- ▷ Windows and upper body region.

If the windows are fogged over, press the AUTO button on the driver's side to utilize the condensation sensor.

### Temperature



Turn the wheel to set the desired temperature.

The automatic climate control achieves this temperature as quickly as possible, if necessary with the maximum cooling or heating capacity, and then keeps it constant.

Avoid rapidly switching between different temperature settings. Otherwise, the automatic climate control will not have sufficient time to adjust the set temperature.

### AUTO program



Press the button.

Air flow, air distribution, and temperature are controlled automatically.

Depending on the selected temperature, AUTO intensity program and outside influences, the air is directed to the windshield, side windows, upper body, and into the footwell.

The cooling function, refer to page 167, is switched on automatically with the AUTO program.

At the same time, a condensation sensor controls the program so as to prevent window condensation as much as possible.

### Intensity of the AUTO program

With the AUTO program switched on, automatic control of the air flow and air distribution can be adjusted.



Press the left or right side of the button: decrease or increase the intensity.

The selected intensity is shown on the display of the automatic climate control.

### Air flow, manual

To be able to manually adjust the air flow, switch off the AUTO program first.



Press the left or right side of the button: decrease or increase air flow.

The selected air flow is shown on the display of the automatic climate control.

The air flow of the automatic climate control may be reduced automatically to save battery power.

### Defrosting windows and removing condensation



Press the button.

Ice and condensation are quickly removed from the windshield and the front side windows.

The air volume can be adjusted when the program is active.

If the windows are fogged over, you can also switch on the cooling function or press the AUTO button to utilize the condensation sensor.

## Maximum cooling

 Press the button.

The system is set to the lowest temperature, maximum air flow and air circulation mode.

Air flows out of the vents for the upper body region. The vents need to be open for this.

The function is available above an external temperature of approx. 32 °F/0 °C and with the engine running is indicated.

The air flow can be adjusted when the program is active.

## Automatic recirculated-air control/ recirculated-air mode

You can respond to unpleasant odors or pollutants in the immediate environment by temporarily suspending the supply of outside air. The system then recirculates the air currently within the vehicle.

 Press the button repeatedly to select an operating mode:

- ▶ LEDs off: outside air flows in continuously.
- ▶ Left LED on, automatic recirculated-air control: a sensor detects pollutants in the outside air and controls the shutoff automatically.
- ▶ Right LED on, recirculated-air mode: the supply of outside air into the vehicle is permanently blocked.

If the windows are fogged over, switch off the recirculated-air mode and press the AUTO button on the driver's side to utilize the condensation sensor. Make sure that air can flow onto the windshield.

 **Continuous recirculated-air mode**  
The recirculated-air mode should not be used for an extended period of time, as the air quality inside the vehicle deteriorates steadily. ◀

## Cooling function

The passenger compartment can only be cooled with the engine running.

 Press the button.  
The air is cooled and dehumidified and, depending on the temperature setting, warmed again.

Depending on the weather, the windshield may fog up briefly when the engine is started.

The cooling function is switched on automatically with the AUTO program.

When using the automatic climate control, condensation water, refer to page 192, develops that exits underneath the vehicle.

## Rear window defroster

 Press the button.  
The rear window defroster switches off automatically after a certain period of time.

## SYNC program

 The current settings on the driver's side for temperature, air flow, air distribution, and AUTO program are transferred to the front passenger side and to the left and right rear.

The program is switched off if the settings on the front passenger side or in the rear are changed.

## Residual heat

The heat stored in the engine is used to heat the interior.

## Functional requirement

- ▶ Up to 15 minutes after switching off the engine.
- ▶ Warm engine.
- ▶ The battery is sufficiently charged.
- ▶ External temperature below 77 °F/25 °C.

## Switching on

1. Switch off the ignition.
2.  Press the right side of the button on the driver's side.

⏏ The symbol appears on the automatic climate Control Display.

The interior temperature, air volume and air distribution can be adjusted with the ignition switched on.

## Switching off

At the lowest fan speed, press the left side of the button on the driver's side.

⏏ The symbol on the display of the automatic climate control flashes.

## Switching the system on/off

### Switching off

- ▷ Complete system:

 Press and hold the left button on the driver's side until the control clicks off.

- ▷ On the front passenger side:

 Press and hold the left button on the front passenger side.

### Switching on

Press any button except:

- ▷ SYNC program.
- ▷ Rear window defroster.
- ▷ Left side of Air volume button.
- ▷ Seat heating.
- ▷ Seat ventilation.

## Microfilter/activated-charcoal filter

The microfilter removes dust and pollen from the incoming air.

The activated-charcoal filter removes gaseous pollutants from the outside air that enters the vehicle.

This combined filter should be replaced during scheduled maintenance, refer to page 229, of your vehicle.

## Ventilation

### Front ventilation

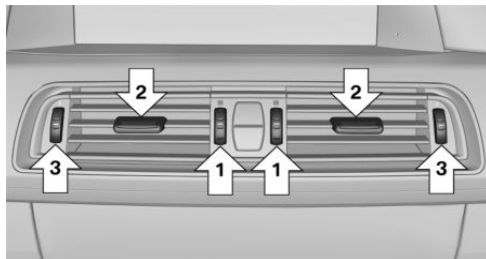

- ▷ Thumbwheels to vary the temperature, arrow 1.  
Toward blue: colder.  
Toward red: warmer.
- ▷ Lever for changing the air flow direction, arrow 2.
- ▷ Thumbwheels for opening and closing the vents continuously, arrows 3.

### Adjusting the ventilation

- ▷ Ventilation for cooling:  
Adjust the vent to direct the air in your direction, e.g., if the vehicle interior is hot from the sun.
- ▷ Draft-free ventilation:  
Adjust the vent to let the air flow past you.



## Ventilation in rear, center

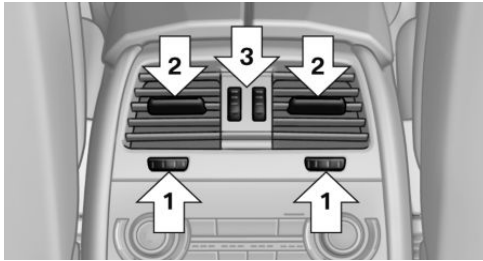

- ▶ Thumbwheels to vary the temperature, arrow 1.  
Toward blue: colder.  
Toward red: warmer.
- ▶ Lever for changing the air flow direction, arrow 2.
- ▶ Thumbwheels for continuous opening and closing of the vents, arrow 3.

## Lateral ventilation

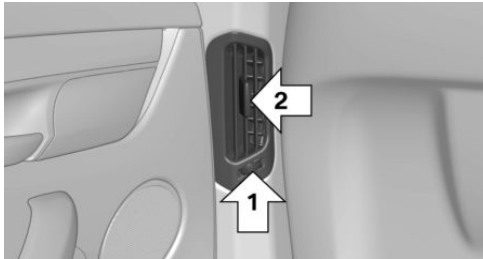

- ▶ Thumbwheel for opening and closing the vents continuously, arrow 1.
- ▶ Lever for changing the air flow direction, arrow 2.

## Heating and ventilation, third row of seats

The air in the area of the third row of seats can be heated or circulated. The vents are located in the storage area between the seats and in the footwell of the third row of seats.

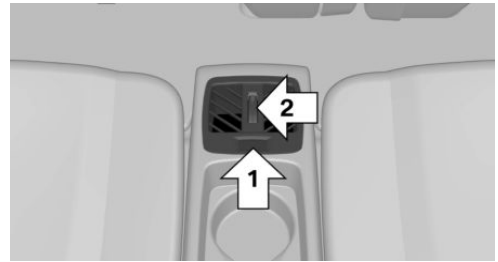

- ▶ Button for switching on the fan, arrow 1. LED comes on.
- ▶ Thumbwheel for the activation of the heat and distribution of the air, arrow 2.  
Turn toward the front: activate the heater and distribute the air in the footwell.  
Turn toward the rear: distribute the air in the storage area between the seats.

The heater is not ready for operation without switching on the fan. After the heater is switched off, the fan can be used to circulate the interior air, e.g., at high temperatures. To do this, switch on the fan, arrow 1 and turn the thumbwheel toward the rear, arrow 2.

## Rear automatic climate control

### At a glance



- 1 Temperature
- 2 AUTO program
- 3 Vent settings
- 4 Air volume, AUTO intensity

- 5 Display
- 6 Maximum cooling
- 7 Seat heating 55

## Switching the rear automatic climate control on/off

1. "Settings"
2. "Climate"
3. "Rear climate"

The rear automatic climate control is not operational if the automatic climate control is switched off or if the function for defrosting or defogging the windows is active.

## AUTO program

 Press the button. Air flow, air distribution, and temperature are controlled automatically:

Depending on the selected temperature, the AUTO intensity, and outside influences, the air is directed to the upper body and into the footwell.

The cooling function is switched on automatically with the AUTO program.

## Intensity of the AUTO program

With the AUTO program switched on, automatic control of the air flow and air distribution can be adjusted.

 Press the left or right side of the button: decrease or increase the intensity.

The selected intensity is shown on the display of the automatic climate control.

## Temperature



Turn the wheel to set the desired temperature.

The automatic climate control achieves this temperature as quickly as possible, if necessary by using the maximum cooling or heating capacity, and then keeps it constant.

Avoid rapidly switching between different temperature settings. The automatic climate control will not have sufficient time to adjust the set temperature.

## Manual air distribution

The air distribution can be adjusted to individual needs.



Press the button repeatedly to select a program:

- ▷ Upper body region.
- ▷ Upper body region and footwell.
- ▷ Footwell.

## Air flow, manual

To be able to manually adjust the air flow, switch off the AUTO program first.



Press the left or right side of the button: decrease or increase air flow.

The selected air flow is shown on the display of the automatic climate control.

## Switching the system on/off

### Switching off



Press and hold the left button.

### Switching on

Press any button except:

- ▷ Left side of Air volume button.

- ▷ Seat heating.

## Maximum cooling

 Press the button.

The system is set to the lowest temperature, maximum air flow and air circulation mode.

Air flows out of the vents for the upper body region. Open them for this purpose.

Air is cooled as quickly as possible:

- ▷ At an external temperature of approx. 32 °F/0 °C.
- ▷ When the engine is running.

## Parked-car ventilation/heating

### The concept

The parked-car ventilation ventilates the vehicle interior and lowers its temperature, if necessary.

The parked-car heating warms the vehicle interior, making snow and ice easier to remove. With the ignition switched off, the air is automatically routed to the windshield, to the side windows, and into the footwell.

The systems can be switched on and off directly or by using two preset departure times.

The switch-on time is automatically determined based on the temperature. The systems promptly switch on before the selected departure time.

Operation takes place on the iDrive or the remote control.

### Hints

 Parked-car heating in enclosed areas

Do not operate the parked-car heating in enclosed areas, as breathing of the harmful exhaust fumes may lead to loss of consciousness and death. The exhaust gases contain carbon

monoxide, an odorless and colorless but highly toxic gas. Switch off the parked-car heating when refueling. ◀



Operation of the parked-car heating

When parked-car heating is in operation, high temperatures can occur under the car body. Before the parked-car heating is switched on, make sure that no flammable materials, such as hay, leaves, grass, etc. are under the vehicle. Such contact could lead to a fire, and with it the risk of serious personal injury as well as property damage. ◀

At external temperatures below 32 °F/0 °C, water vapor occurs that emerges from below the vehicle.

## Functional requirements

### Parked-car ventilation

- ▷ With remote control or when the departure time is preselected: depends on internal, external and set temperature.
- ▷ Direct operation via iDrive: any external temperature.
- ▷ In direct mode via remote control: external temperature above approx. 59 °F/15 °C.

Open the vents to allow air to flow out.

### Parked-car heating

- ▷ With remote control or when the departure time is preselected: depends on internal, external and set temperature.
- ▷ Direct operation via iDrive: any external temperature.
- ▷ In direct mode via remote control: external temperature below approx. 59 °F/15 °C.
- ▷ The battery is sufficiently charged.
- ▷ The fuel tank is filled to above the reserve range.

If the parked-car heating has not been used for several months, it may be necessary to switch the system on again after several minutes.

## Switching on/off directly

1. "Settings"
2. "Climate"
3. "Activate comfort heating" or "Activate conf. ventilation"

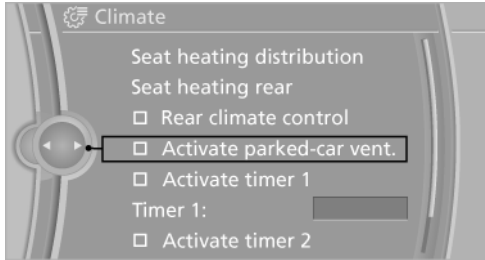

☞ The symbol on the automatic climate control flashes if the system is switched on.

The system continues to run for some time after being switched off.

## Preselecting the departure time

1. "Settings"
2. "Climate"
3. "Dep. time 1:" or "Dep. time 2:"
4. Set the desired time.

## Activating the departure time

1. "Settings"
2. "Climate"
3. "Activate depart. time 1" or "Activate depart. time 2"

☞ The symbol on the automatic climate control lights up when the departure time is activated.

☞ The symbol on the automatic climate control flashes when the system has been switched on.

The system will only be switched on within the next 24 hours. After that, it needs to be reactivated.



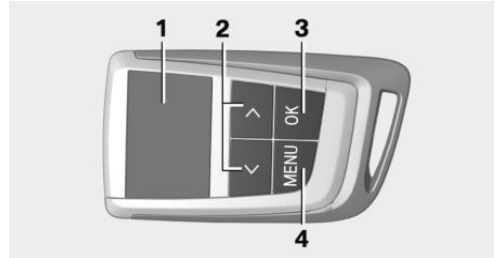

## Remote control

### At a glance











- 1 Display
- 2 Selection buttons
- 3 OK
- 4 MENU

### Buttons

Press the button	Function
	Decrease or increase the selection.
	
	Press briefly: - Switch on remote control. - Switch menu. Press and hold down: - Switch off remote control.
	Confirm the selection.

### Symbols

Symbols	Meaning
	Parked-car ventilation/heating
1 	Timer 1.
2 	Timer 2.

Symbols	Meaning
	Radio reception.
	Remote control battery indicator.
	Parked-car ventilation/heating fault.
	Tank contents too low.
	Vehicle battery charging state too low.
	No radio reception.

### Switching on

 Press button briefly until the display lights up.

The last menu opened is displayed.



### Switching off

 Press for approx. 2 seconds until the display is switched off.

If no entry is made for 10 seconds, the display shuts off automatically.

### Select menu

The following menus can be selected via the remote control.

- ▶  Parked-car ventilation/heating
- ▶ 1  Timer 1
- ▶ 2  Timer 2

 Press the button repeatedly until the desired menu is displayed.

### Activating/deactivating the functions



Several menu items are preceded by a check-box. It indicates whether the function is activated or deactivated. Selecting the menu item activates or deactivates the function.

 The function is activated.



 The function is deactivated.

### Parked-car ventilation/heating

#### Activating

1.  Select menu.
2.  Press button to activate parked-car ventilation/heating.

#### Deactivating







1.  Select menu.
2.  Press button to deactivate parked-car ventilation/heating.

### Timer

Two timers can be set with different times.

Only one timer can ever be activated.

#### Activating

1. Select Timer 1 or Timer 2.
2.   Press the button to set the hour.
3.  Press the button.
4.   Press the button to set the minute.
5.  Press the button twice to activate the timer.

#### Deactivating

1. Select desired timer.
2.  Press the button to deactivate the timer.

### Remote control range

The reception-dependent average range is approx. 490 ft/150 m.

The range is greatest if the remote control is kept horizontally toward the front.

## Frequencies

The remote control may not function properly if it experiences interference from other systems or devices that use the same frequency.

## Replacing the batteries

Replace the batteries if a check control message is displayed or the battery indicator flashes.



No rechargeable batteries

Do not use rechargeable batteries, as damage may result from the substances in the batteries. ◀



1. Use a suitable object to unclip the battery compartment, arrow 1.
2. Remove the cover of the battery compartment, arrow 2.
3. Insert batteries of the same type.
4. Press the cover closed.



Take the used battery to a recycling center or to your service center.

## Malfunction

 The symbol indicates that there is a fault in the parked-car ventilation/heating. Have the system checked by the service center.

# Interior equipment

## Vehicle equipment

All standard, country-specific and optional equipment that is offered in the model series is described in this chapter. Therefore, equipment is also described that is not available in a vehicle, e. g., because of the selected optional equipment or country variant. This also applies for safety-related functions and systems.

## Universal garage door opener

### The concept

The universal garage door opener can operate up to 3 functions of remote-controlled systems such as garage door drives or lighting systems. The universal garage door opener replaces up to 3 different hand-held transmitters. To operate the remote control, the buttons on the interior rearview mirror must be programmed with the desired functions. The hand-held transmitter for the particular system is required in order to program the remote control.

 During programming

During programming and before activating a device using the integrated universal remote control, ensure that there are no people, animals, or objects in the range of movement of the remote-controlled device; otherwise, there is a risk of injury or damage.

Also follow the safety instructions of the hand-held transmitter. ◀

Before selling the vehicle, delete the stored functions for the sake of security.

### Compatibility

 If this symbol is printed on the packaging or in the instructions of the system to be controlled, the system is gener-

ally compatible with the universal garage door opener.

If you have any questions, please contact:

- ▷ Your service center.
- ▷ [www.homelink.com](http://www.homelink.com) on the Internet.

HomeLink is a registered trademark of Johnson Controls, Inc.

## Controls on the interior rearview mirror

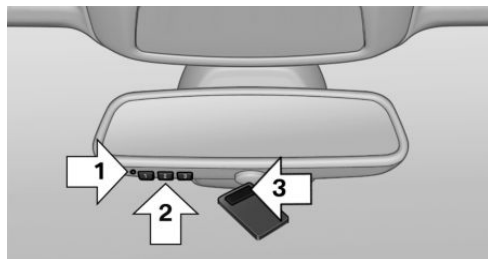

- ▷ LED, arrow 1.
- ▷ Buttons, arrow 2.
- ▷ The hand-held transmitter, arrow 3, is required for programming.

## Programming

### General information

1. Switch on the ignition.
2. Initial setup:
 

Press and hold the left and right button on the interior rearview mirror simultaneously for approximately 20 seconds until the LED on the interior rearview mirror flashes. This erases all programming of the buttons on the interior rearview mirror.
3. Hold the hand-held transmitter for the system to be controlled approx. 1 to 3 in/2.5 to 8 cm away from the buttons on the interior

rearview mirror. The required distance depends on the manual transmitter.

4. Simultaneously press and hold the button of the desired function on the hand-held transmitter and the button to be programmed on the interior rearview mirror. The LED on the interior rearview mirror will begin flashing slowly.
5. Release both buttons as soon as the LED flashes more rapidly. When the LED is flashing faster, this indicates that the button on the interior rearview mirror has been programmed.

If the LED does not flash faster after at least 60 seconds, change the distance between the interior rearview mirror and the hand-held transmitter and repeat the step. Several more attempts at different distances may be necessary. Wait at least 15 seconds between attempts.

Canada: if programming with the hand-held transmitter was interrupted, hold down the interior rearview mirror button and repeatedly press and release the hand-held transmitter button for 2 seconds.

6. To program other functions on other buttons, repeat steps 3 to 5.

The systems can be controlled using the interior rearview mirror buttons.

### Special feature of the alternating-code wireless system

If you are unable to operate the system after repeated programming, please check if the system to be controlled features an alternating-code system.

Read the system's operating manual, or press the programmed button on the interior rearview mirror longer. If the LED on the interior rearview mirror starts flashing rapidly and then stays lit constantly for 2 seconds, the system features an alternating-code system. Flashing

and continuous illumination of the LED will repeat for approximately 20 seconds.

For systems with an alternating-code system, the universal garage door opener and the system also have to be synchronized.

Please read the operating manual of the system being set up for information on how to synchronize the system.

Synchronizing is easier with the aid of a second person.

To synchronize:

1. Park the vehicle within range of the remote-controlled system.
2. Program the relevant button on the interior rearview mirror as described.
3. Locate and press the synchronizing button on the system being programmed. You have approx. 30 seconds for the next step.
4. Hold down the programmed button on the interior rearview mirror for approximately 3 seconds and then release it. If necessary, repeat this work step up to three times in order to finish synchronization. Once synchronization is complete, the programmed function will be carried out.

### Reprogramming individual buttons

1. Switch on the ignition.
2. Press and hold the interior rearview mirror button to be programmed.
3. As soon as the interior rearview mirror LED starts flashing slowly, hold the hand-held transmitter for the system to be controlled approx. 1 to 3 in/2.5 to 8 cm away from the buttons on the interior rearview mirror. The required distance depends on the manual transmitter.
4. Likewise, press and hold the button of the desired function on the hand-held transmitter.
5. Release both buttons as soon as the interior rearview mirror LED flashes more rapidly. When the LED is flashing faster, this



indicates that the button on the interior rearview mirror has been programmed. The system can then be controlled by the button on the interior rearview mirror.

If the LED does not flash faster after at least 60 seconds, change the distance and repeat the step. Several more attempts at different distances may be necessary. Wait at least 15 seconds between attempts.

Canada: if programming with the hand-held transmitter was interrupted, hold down the interior rearview mirror button and repeatedly press and release the hand-held transmitter button for 2 seconds.

## Controls



Before operation

Before operating a system using the integrated universal remote control, ensure that there are no people, animals, or objects within the range of movement of the remote-controlled system; otherwise, there is a risk of injury or damage.

Also follow the safety instructions of the hand-held transmitter. ◀

The system, such as the garage door, can be operated using the button on the interior rearview mirror while the engine is running or when the ignition is started. To do this, hold down the button within receiving range of the system until the function is activated. The interior rearview mirror LED stays lit while the wireless signal is being transmitted.

## Deleting stored functions

Press and hold the left and right button on the interior rearview mirror simultaneously for approximately 20 seconds until the LED flashes rapidly. All stored functions are deleted. The functions cannot be deleted individually.

## Ashtray

### Front

### Opening

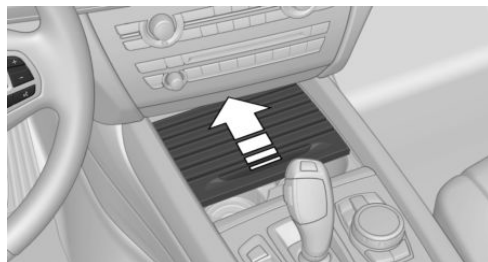

Slide the cover forward.

### Emptying

Take out the insert.

## Lighter

### Hints



Danger of burns

Only hold the hot lighter by its knob; otherwise, there is the danger of getting burned.

Switch off the ignition and take the remote control with you when leaving the vehicle so that children cannot use the lighter and burn themselves. ◀



Replace the cover after use

Reinsert the lighter or socket cover after use, otherwise objects may get into the lighter socket or fixture and cause a short circuit. ◀

## Front

### At a glance

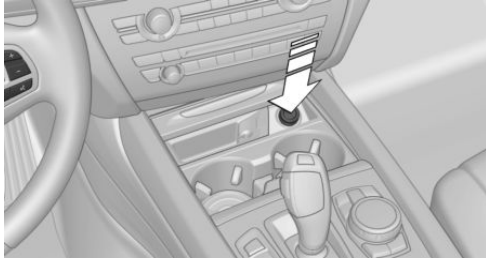

The lighter is located next to the ashtray.

### Controls



Push in the lighter.

The lighter can be removed as soon as it pops back out.

## Rear

### At a glance



The cigarette lighter is located in the rear center console.

### Controls



Push in the lighter.

The lighter can be removed as soon as it pops back out.

## Connecting electrical devices

### Hints



Do not plug chargers into the socket

Do not connect battery chargers to the factory-installed sockets in the vehicle as this may damage the battery. ◀



Replace the cover after use

Reinsert the lighter or socket cover after use, otherwise objects may get into the lighter socket or fixture and cause a short circuit. ◀

### Sockets

The lighter socket can be used as a socket for electrical equipment while the engine is running or when the ignition is switched on. The total load of all sockets must not exceed 140 watts at 12 volts.

Do not damage the socket by using unsuitable connectors.

### Front center console

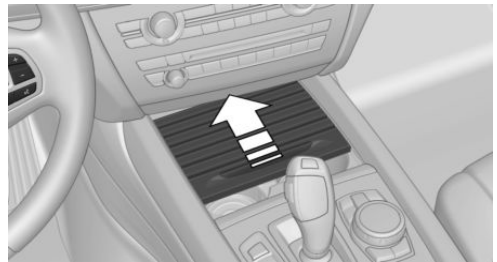

Slide the cover forward.

Remove the cover or cigarette lighter.

## Center armrest



Remove the cover.

## Rear center console



Remove the cover or cigarette lighter.

## In the cargo area



Fold open the cover.

## USB interface for data transfer

### The concept

Connection for importing and exporting data on USB devices, e.g.:

- ▷ Personal Profile settings, refer to page 35.
- ▷ Music collection, see user's manual for Navigation, Entertainment and Communication.

### At a glance

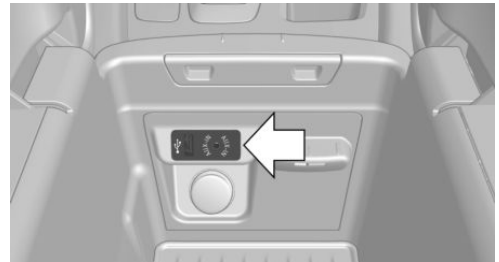

The USB interface is located in the center armrest.

### Notes

Observe the following when connecting:

- ▷ Do not use force when plugging the connector into the USB interface.
- ▷ Do not connect devices such as fans or lamps to the USB interface.
- ▷ Do not connect USB hard drives.
- ▷ Do not use the USB interface to recharge external devices.

## Cargo area

### Cargo cover

#### Hints



Hook the cargo cover on both sides

Hook the cargo cover on both sides to prevent damaging the cover. ◀



Do not deposit heavy objects

Do not deposit heavy or hard objects on the cargo cover. Otherwise, they may pose a risk to occupants, such as during braking and avoidance maneuvers. ◀



Do not let the trunk cover snap back into place

Do not allow the trunk cover to snap back into place; this can damage it. ◀

### Attaching

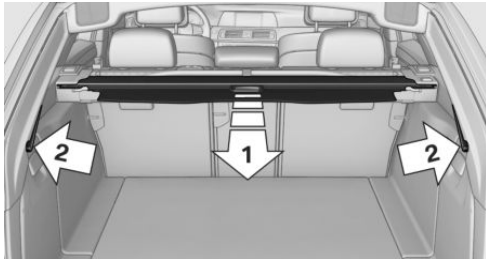

1. Remove cargo cover, arrow 1.
2. Hook cargo cover into the brackets on both sides, arrow 2

### Removing

The cover can be removed to load bulky luggage.

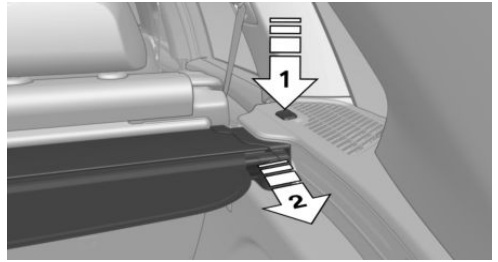

1. Press the button, arrow 1, to unlock the cover.
2. Pull the cover back, arrow 2.

### Installing

Slide the cover forward horizontally into the two side brackets until it audibly latches. The red warning fields disappear. Tug on the cover to check if it is properly locked in place.

### Enlarging the cargo area

#### General information

The cargo area can be enlarged by folding down the rear seat backrest.

The rear seat backrest is divided at a ratio of 40–20–40. The sides and the middle section can be folded down separately.

#### Hints



Danger of pinching

Before folding down the rear seat backrests, ensure that the area of movement of the backrests is clear. In particular, ensure that no one is located in or reaches into the area of movement of the rear seat backrests when the middle section is folded down. Otherwise, injury or damage may result. ◀



Lock the rear seat backrests in position

Before installation of child restraint systems on the rear seat backrest, set a backrest tilt at which the childseat rests firmly against the backrest and securely latch all backrests. Otherwise, the stability of the child seat is limited.

ited, and there is an increased risk of injury because of unexpected movement of the rear seat backrest. ◀

**!** Ensure that the lock is securely engaged

When folding back the backrest, make sure that it securely locks in place. When this happens the red warning field on the seat disappears. If the backrest is not properly engaged, transported cargo could enter the passenger compartment during braking or evasive maneuvers and endanger the vehicle occupants. ◀

**!** Using the middle safety belt

If the middle safety belt in the rear is used, the larger section of the backrest must be locked. Otherwise, the safety belt will not have a restraining effect. ◀

### Folding down the sides

**!** Move the front seats to an upright position

Before folding down the rear backrests, ensure that the front seats are moved forward slightly and are in an upright position. Otherwise, the head restraint and screen could be damaged. ◀



Reach into the recess and pull forward.

### Folding down the middle section

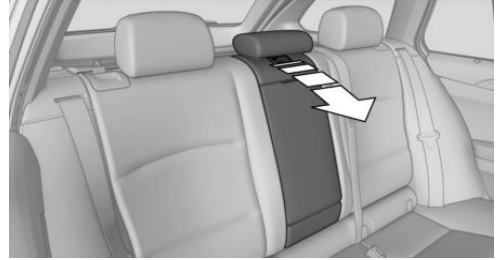

Reach into the recess and pull forward.

## Ski and snowboard bag

### General information

The ski and snowboard bag is contained in a protective jacket in the cargo area.

Follow the installation and operation instructions included in the protective jacket.

## Sun visor

### Glare shield from the side

#### Folding out

1. Fold the sun visor down.
2. Unhook it from the holder and swing it to the side.
3. Move it back to the desired position.

#### Folding up

Proceed in the reverse order to close the sun visor.

# Storage compartments

## Vehicle equipment

All standard, country-specific and optional equipment that is offered in the model series is described in this chapter. Therefore, equipment is also described that is not available in a vehicle, e. g., because of the selected optional equipment or country variant. This also applies for safety-related functions and systems.

## Notes

 No loose objects in the passenger compartment

Do not stow any objects in the passenger compartment without securing them; otherwise, they may present a danger to occupants for instance during braking and avoidance maneuvers. ◀

 Do not place anti-slip mats on the dashboard

Do not place anti-slip mats on the dashboard. The mat materials could damage the dashboard. ◀

## Storage compartments

The following storage compartments are available in the vehicle interior:

- ▷ Glove compartment on the front passenger side, refer to page 182.
- ▷ Glove compartment on the driver's side, refer to page 183.
- ▷ Compartments in the doors, refer to page 183.
- ▷ Storage compartment on the center armrest, refer to page 183.
- ▷ Center armrest, refer to page 183
- ▷ Glasses compartment, refer to page 184.

## Glove compartment

### Front passenger side

#### Note

 Close the glove compartment again immediately

Close the glove compartment immediately after use while driving; otherwise, injury may occur during accidents. ◀

### Opening

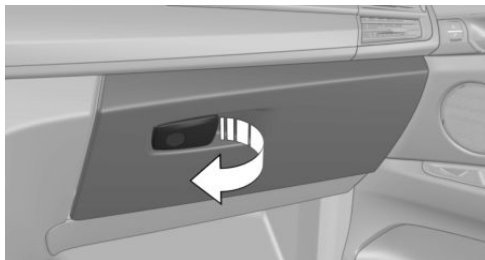

Pull the handle.

The light in the glove compartment switches on.

The net in the glove compartment is used to store small objects.

### Closing

Fold cover closed.

### Locking

After the glove compartment is locked, the remote control can be handed over, such as at a hotel, without the integrated key.

## Driver's side

### Note

 Close the glove compartment again immediately

Close the glove compartment immediately after use while driving; otherwise, injury may occur during accidents. ◀

### Opening

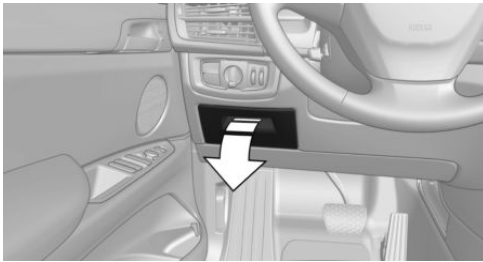

Pull the handle.

### Closing

Fold cover closed.

## Compartments in the doors

 Do not stow any breakable objects

Do not store any breakable objects, e. g. glass bottles, in the compartments, or there is an increased risk of injury in the event of an accident. ◀

## Storage compartment on the center console

### Opening

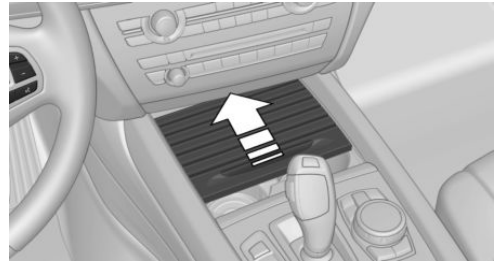

Slide the cover forward.

### Closing

Slide the cover rearward.

### Small storage compartment



Storage possibility for small objects, for example, coins.

## Center armrest

### Front

#### At a glance

Located in the center armrest between the front seats is a storage compartment and depending on how the vehicle is equipped also an elastic band on the left side and a cover for the mobile phone holder or the snap-in adapter.

## Opening

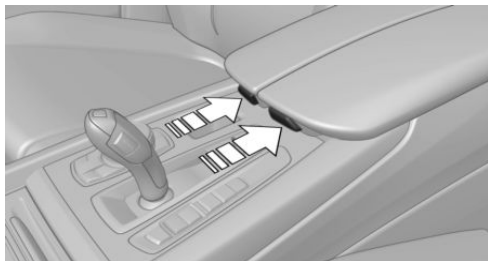

Push the cover down slightly and press the button, see arrow. The respective cover folds up.

## Closing

Fold the respective cover down until it latches.

## Connection for an external audio device

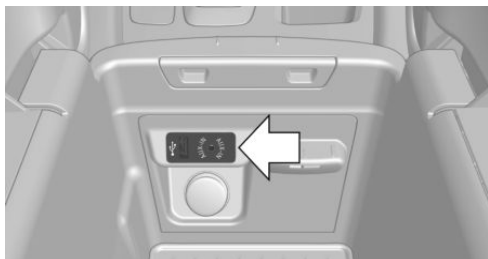

Description, see user's manual for Navigation, Entertainment and Communication.

## Rear

### At a glance

A storage compartment is located in the center armrest between the seats.

## Opening

1. Pull on the loop and fold down the center armrest.

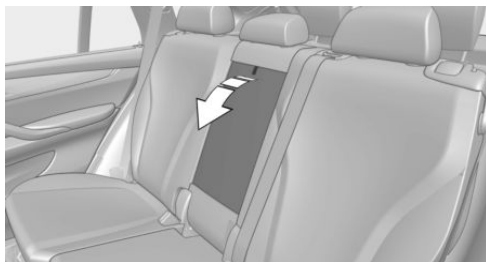

2. Pull the handle.

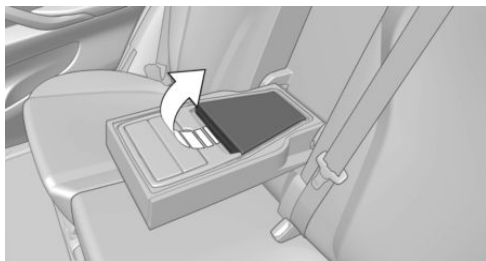

## Closing

Press cover down until it latches.

## Glasses compartment

### At a glance

The glasses compartment is located between the interior mirror and interior lamps.



## Opening

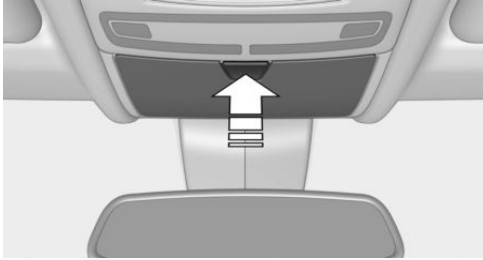

Press the button.

## Closing

Press the cover up until it latches.

## Cupholders

### Hints



Shatter-proof containers and no hot drinks

Use light and shatter-proof containers and do not transport hot drinks. Otherwise, there is the increased danger of injury in an accident. ◀



Unsuitable containers

Do not forcefully push unsuitable containers into the cupholders. This may result in damage. ◀

### Front

#### At a glance

In the center console.

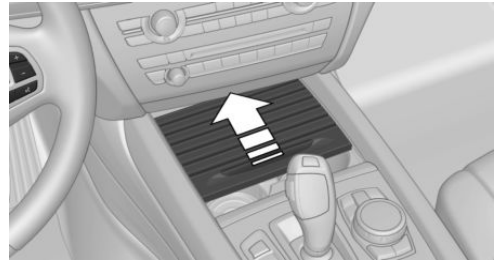

Slide the cover forward.



Two cupholders are located in the center console.

### Rear

#### Note



Pushing back the covers

Push back the covers before folding up the center armrest; otherwise, the cupholder could become damaged. ◀

#### At a glance

In the center armrest.

## Opening

1. Pull on the loop and fold down the center armrest.

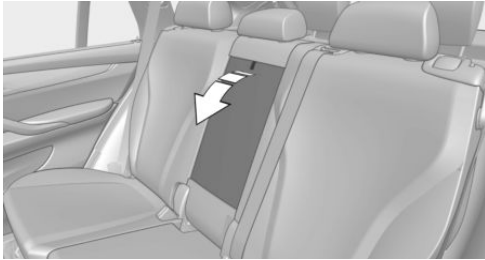

2. Press the button.

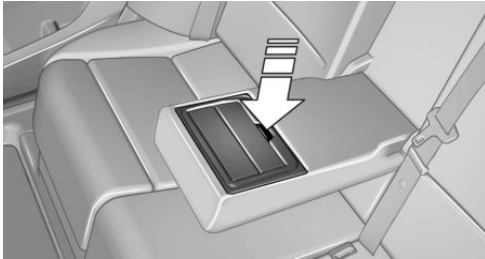

## Closing

Press both covers inward back against each other.

## Third row of seats

### At a glance

The drink holder is located between the seats of third row of seats.

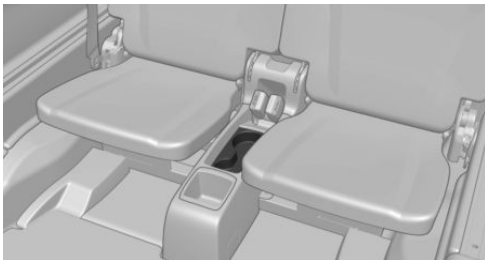

## Clothes hooks

The clothes hooks are located in the grab handles in the rear.



Do not obstruct view

When suspending clothing from the hooks, ensure that it will not obstruct the driver's vision. ◀



No heavy objects

Do not hang heavy objects from the hooks; otherwise, they may present a danger to passengers during braking and evasive maneuvers. ◀

## Storage compartments in the cargo area

### Storage space under the cargo floor cover

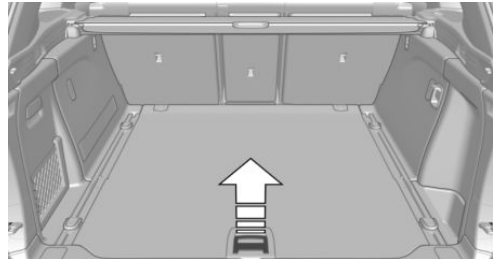

Raise the cargo floor panel. The storage space under the cargo floor panel is subdivided.

### Hooks/multi-function hook

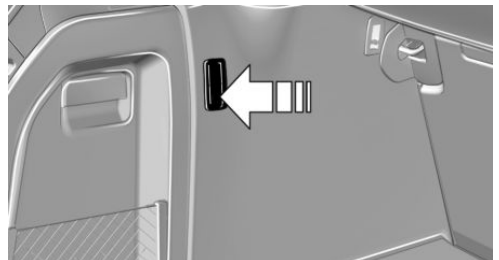

## Retaining strap

A retaining strap is available on the right side trim for fastening small objects.

## Net

Smaller objects can be stored in the net on the left side of the cargo area.

## Storage compartment on the right side

A waterproof storage compartment is available on the right side of the cargo area floor.

## Left side storage compartment

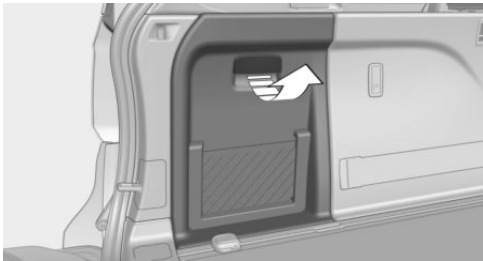

Pull the handle.

## Lashing eyes in the cargo area

To secure the cargo, refer to page [195](#), there are lashing eyes in the cargo area.

## Lashing eyes in the cargo area with rail

To secure the cargo, refer to page [195](#), there are lashing eyes in the cargo area.

## Cargo net, FlexNet

To secure the cargo, refer to page [195](#), the flexible cargo net can also be used.



## Driving tips

This chapter provides you with information useful in dealing with specific driving and operating modes.

# Things to remember when driving

## Vehicle equipment

All standard, country-specific and optional equipment that is offered in the model series is described in this chapter. Therefore, equipment is also described that is not available in a vehicle, e. g., because of the selected optional equipment or country variant. This also applies for safety-related functions and systems.

## Breaking-in period

### General information

Moving parts need to be broken in to adjust to each other.

The following instructions will help achieve a long vehicle life and good economy.

### Engine and differential

Always obey the official speed limit.

### Up to 1,200 miles/2,000 km

Do not exceed the maximum engine and road speed:

- ▶ For gasoline engine 4,500 rpm and 100 mph/160 km/h.
- ▶ For diesel engine 3,500 rpm and 93 mph/150 km/h.

Avoid full load or kickdown under all circumstances.

### From 1,200 miles/2,000 km

The engine and vehicle speed can gradually be increased.

### Tires

Due to technical factors associated with their manufacture, tires do not achieve their full traction potential until after an initial breaking-in period.

Drive conservatively for the first 200 miles/300 km.

### Brake system

Brakes require an initial break-in period of approx. 300 miles/500 km to achieve optimized contact and wear patterns between brake discs and brake pads. Drive moderately during this break-in period.

### Following part replacement

The same breaking in procedures should be observed if any of the components mentioned above have to be renewed in the course of the vehicle's operating life.

## General driving notes

### Closing the tailgate



Drive with the tailgate closed

Only drive with the tailgate closed; otherwise, in the event of an accident or braking and evasive maneuvers, passengers and other road users may be injured, and the vehicle may be damaged. In addition, exhaust fumes may enter the passenger compartment. ◀

If driving with the tailgate open cannot be avoided:

- ▶ Close all windows and the glass sunroof.
- ▶ Greatly increase the blower speed.
- ▶ Drive moderately.

### Hot exhaust system



Hot exhaust system

High temperatures are generated in the exhaust system.

Do not remove the heat shields installed and never apply undercoating to them. Make sure that flammable materials, e. g. hay, leaves, grass, etc. do not come in contact with the hot exhaust system during driving, while in idle position mode, or when parked. Such contact could lead to a fire, and with it the risk of serious personal injury as well as property damage.

Do not touch hot exhaust pipes; otherwise, there is the danger of getting burned. ◀

### Diesel particulate filter

The diesel particulate filter collects soot particles and burns them periodically at high temperatures.

During the cleaning time of several minutes, the following may occur:

- ▷ Temporarily, the engine may run less smoothly.
- ▷ Noises and a slight amount of smoke coming from the exhaust until shortly after the engine is shut down.
- ▷ A somewhat higher engine speed is necessary to achieve the accustomed performance.

### Climate control windshield

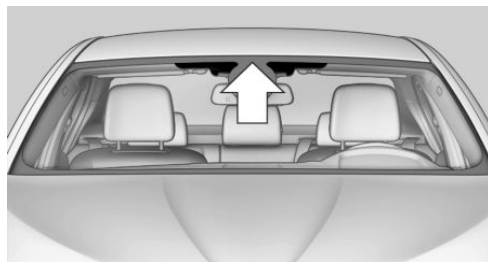

The marked area is not covered with heat reflective coating.

Use this area for garage door openers, devices for electronic toll collection, etc.

### Mobile communication devices in the vehicle



Mobile communication devices in the vehicle

It is advised that you do not use mobile communication devices, e.g., mobile phones, inside the vehicle without connecting them directly to the external antenna. Otherwise, the vehicle electronics and mobile communication devices can interfere with each other. In addition, there is no assurance that the radiation generated during transmission will be discharged from the vehicle interior. ◀

### Hydroplaning

On wet or slushy roads, a wedge of water can form between the tires and road surface.

This phenomenon is referred to as hydroplaning. It is characterized by a partial or complete loss of contact between the tires and the road surface, ultimately undermining your ability to steer and brake the vehicle.



Hydroplaning

When driving on wet or slushy roads, reduce your speed to prevent hydroplaning. ◀

### Driving through water

For calm water, maximum water depth:

- ▷ X5: 19.6 inches/50 cm

At this max. depth, drive at walking speed.



Adhere to water depth and speed limitations

Do not exceed this water depth and walking speed; otherwise, the vehicle's engine, the electrical systems and the transmission may be damaged.

If the vehicle has parked-car heating, drive through water only if it is not deeper than 9.8 inches/25 cm, and at this height no faster than walking speed. ◀

## Braking safely

Your vehicle is equipped with ABS as a standard feature.

Applying the brakes fully is the most effective way of braking in situations when this is necessary.

The vehicle maintains steering responsiveness. You can still avoid any obstacles with a minimum of steering effort.

Pulsation of the brake pedal and sounds from the hydraulic circuits indicate that ABS is in its active mode.

## Objects within the range of movement of the pedals

 No objects in the area around the pedals  
Keep floor mats, carpets, and any other objects out of the area of motion of the pedals; otherwise, the function of the pedals could be impeded while driving and create the risk of an accident.

Do not place additional floor mats over existing mats or other objects.

Only use floor mats that have been approved for the vehicle and can be properly fixed in place.

Ensure that the floor mats are securely fastened again after they were removed for cleaning, for example. ◀

## Driving in wet conditions

When roads are wet coated with road salt or there is heavy rain, briefly exert gentle pressure on the brake pedal every few miles.

Ensure that this action does not endanger other road users.

The heat generated in this process helps dry the brake discs and pads.

In this way braking efficiency will be available when you need it.

## Hills

Drive long or steep downhill gradients in the gear in which the least braking is required. Otherwise, the brake system may overheat, resulting in a reduction in the brake system efficiency.

You can increase the engine's braking effect by shifting down, going all the way to first gear, if necessary.



Avoid load on the brakes

Avoid placing excessive load on the brake system. Light but consistent brake pressure can lead to high temperatures, brake wear and possibly even brake failure. ◀



Do not drive in neutral

Do not drive in neutral or with the engine stopped, as doing so disables engine braking. In addition, steering and brake assist are unavailable with the engine stopped. ◀

## Brake disc corrosion

The corrosion on the brake discs and the contamination on the brake pads are furthered by:

- ▷ Low mileage.
- ▷ Extended periods when the vehicle is not used at all.
- ▷ Infrequent use of the brakes.

Corrosion occurs when the minimum pressure that must be exerted by the pads during brake applications to clean the discs is not reached.

Should corrosion form on the brake discs, the brakes will tend to respond with a pulsating effect that generally cannot be corrected.

## Condensation under the parked vehicle

When using the automatic climate control, condensation water develops that exits underneath the vehicle.

Traces of water under the vehicle like this are normal.



## Driving on poor roads

The vehicle connects four wheel drive to the advantages of a normal truck



Do not drive on unpaved terrain

Do not drive on unpaved terrain; otherwise, the vehicle may be damaged. ◀

For your own safety, for the safety of passengers and of the vehicle, heed the following points:

- ▶ Become familiar with the vehicle before starting a trip; do not take risks in driving.
- ▶ Adjust the speed to the road surface conditions. The steeper and more uneven the road surface, the slower the speed should be.
- ▶ When driving on steep uphill or downhill grades: add engine oil and coolant up to near the MAX mark. Uphill and downhill grades can be traveled up to no more than 50 %.
- ▶ On steep downhill grades, use Hill Descent Control HDC, refer to page [133](#).

Starting out is possible on uphill grades up to 33 %. The permissible side tilt is 50 %.

- ▶ Avoid contact of the bottom of the body with the ground.  
The ground clearance is no more than 7.8 inches/20 cm and can vary according to the loading condition.
- ▶ When wheels continue to turn, depress the accelerator so that driving stability control systems can distribute the driving force to the wheels. Activate DTC Dynamic Traction Control if available.

### After a trip on poor roads

After a trip on poor roads, check wheels and tires for damage to maintain driving safety. Clear heavy soiling from the body.

# Loading

## Vehicle equipment

All standard, country-specific and optional equipment that is offered in the model series is described in this chapter. Therefore, equipment is also described that is not available in a vehicle, e. g., because of the selected optional equipment or country variant. This also applies for safety-related functions and systems.

## General information

### Overloading the vehicle

To avoid exceeding the approved carrying capacity of the tires, never overload the vehicle. Overloading can lead to overheating and increases the rate at which damage develops inside the tires. This could result in a sudden loss of tire inflation pressure. ◀

### No fluids in the trunk

Make sure that fluids do not leak into the trunk; otherwise, the vehicle may be damaged. ◀

## Determining the load limit

1. Locate the following statement on your vehicle's placard:
  - ▶ The combined weight of occupants and cargo should never exceed XXX kg or YYY lbs. Otherwise, damage to the

vehicle and unstable driving situations may result.



2. Determine the combined weight of the driver and passengers that will be riding in your vehicle.
3. Subtract the combined weight of the driver and passengers from XXX kilograms or YYY pounds.
4. The resulting figure equals the available amount of cargo and luggage load capacity.  
  
For example, if the YYY amount equals 1,000 lbs and there will be four 150 lbs passengers in your vehicle, the amount of available cargo and luggage load capacity is 400 lbs: 1,000 lbs minus 600 lbs = 400 lbs.
5. Determine the combined weight of luggage and cargo being loaded on the vehicle. That weight may not safely exceed the available cargo and luggage load capacity calculated in Step 4.

## Load

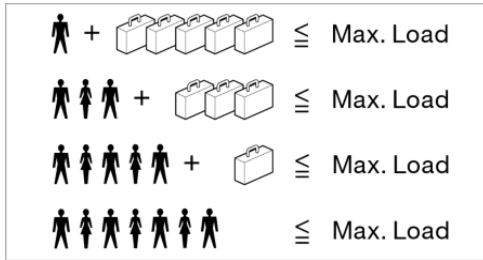

The maximum load is the sum of the weight of the occupants and the cargo.

The greater the weight of the occupants, the less cargo that can be transported.

## Stowing cargo

- Cover sharp edges and corners on the cargo.
- Heavy cargo: stow as far forward as possible, directly behind and at the bottom of the rear passenger seat backrests.
- Very heavy cargo: when the rear seat is not occupied, secure each of the outer safety belts in the opposite buckle.
- If necessary, fold down the rear backrests to stow cargo.
- Do not stack cargo above the top edge of the backrests.

## Securing cargo

### Lashing eyes in the cargo area

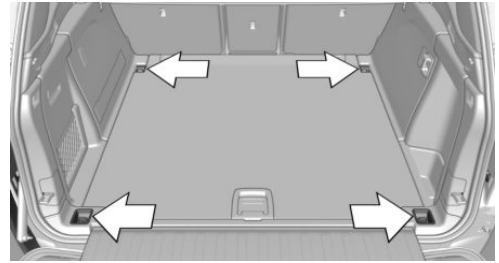

To secure the cargo there are four lashing eyes in the cargo area.

### Lashing eyes in the cargo area with rails

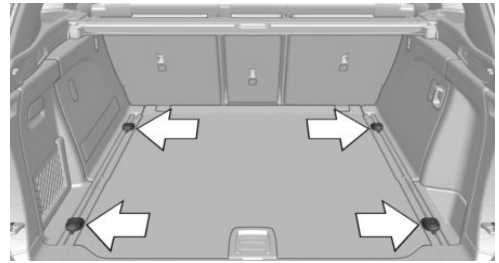

To secure the cargo, there are four movable lashing eyes in the cargo area.

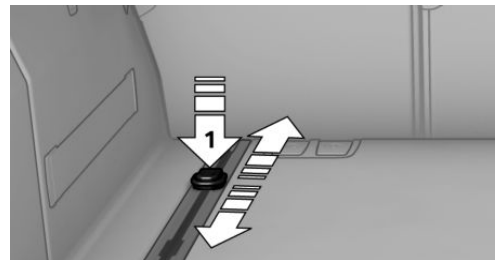

To slide the lashing eyes, press the button, arrow 1. Make sure that the lashing eyes latch at the new position.

If available, the lashing eyes are located under the cargo floor cover in the cargo area. They can be inserted into the openings in the rails.

### Securing cargo

- ▷ Smaller and lighter items: secure with retaining straps or with a cargo net or draw straps.
- ▷ Larger and heavy objects: secure with cargo straps.

Cargo straps, cargo netting, retaining straps or draw straps on the lashing eyes in the cargo area.



#### Securing cargo

Always position and secure the cargo as described above; otherwise, it can endanger the car's occupants if sudden braking or swerving becomes necessary.

Heavy or hard objects should not be carried loose inside the car; otherwise, they could be thrown around as a result of hard braking, sudden swerves, etc., and endanger the occupants. ◀

Therefore, note the following when loading and driving:

- ▷ Do not exceed the approved roof/axle loads and the approved gross vehicle weight.
- ▷ Distribute the roof load uniformly.
- ▷ The roof load should not be too large in area.
- ▷ Always place the heaviest pieces on the bottom.
- ▷ Secure the roof luggage firmly, e.g., tie with ratchet straps.
- ▷ Do not let objects project into the opening path of the tailgate.
- ▷ Drive cautiously and avoid sudden acceleration and braking maneuvers. Take corners gently.

## Roof-mounted luggage rack

### Note

Installation only possible with roof rack.

Roof racks are available as special accessories.

### Securing

Follow the installation instructions of the roof rack.

### Loading

Be sure that adequate clearance is maintained for tilting and opening the glass sunroof.

Because roof racks raise the vehicle's center of gravity when loaded, they have a major effect on vehicle handling and steering response.

# Saving fuel

## Vehicle equipment

All standard, country-specific and optional equipment that is offered in the model series is described in this chapter. Therefore, equipment is also described that is not available in a vehicle, e. g., because of the selected optional equipment or country variant. This also applies for safety-related functions and systems.

## General information

Fuel consumption depends on a number of different factors.

The implementation of certain measures, driving style and regular maintenance can have an influence on fuel consumption and on the environmental impact.

## Remove unnecessary cargo

Additional weight increases fuel consumption.

## Remove attached parts following use

Remove auxiliary mirrors, roof or rear luggage racks which are no longer required following use.

Attached parts on the vehicle impair the aerodynamics and increase the fuel consumption.

## Close the windows and glass sunroof

Driving with the glass sunroof and windows open results in increased air resistance and thereby reduces the range.

## Tires

### General information

Tires can affect fuel consumption values in various ways, for instance fuel consumption can be influenced by the size of the tires.

### Check the tire inflation pressure regularly

Check and, if necessary, correct the tire inflation pressure at least twice a month and before starting on a long trip.

Low tire inflation pressure increases rolling resistance and thus raises fuel consumption and tire wear.

### Drive away immediately

Do not wait for the engine to warm-up while the vehicle remains stationary. Start driving right away, but at moderate engine speeds.

This is the fastest way for the cold engine to reach its operating temperature.

### Look well ahead when driving

Avoid unnecessary acceleration and braking.

By maintaining a suitable distance to the vehicle driving ahead of you.

Driving smoothly and looking ahead reduces fuel consumption.

### Use coasting

When approaching a red light, take your foot off the accelerator and let the vehicle coast to a halt.

On a downhill gradient, take your foot off the accelerator and let the vehicle roll.

The flow of fuel is interrupted while coasting.

## Switch off the engine during longer stops

Switch off the engine during longer stops, e.g., at traffic lights, railroad crossings or in traffic congestion.

### Auto Start/Stop function

The Auto Start/Stop function of your vehicle automatically switches off the engine during a stop.

If the engine is switched off and then restarted rather than leaving the engine running constantly, fuel consumption and emissions are reduced. Savings can begin within a few seconds of switching off the engine.

Using this system can cause certain components of the vehicle to become worn prematurely.

In addition, fuel consumption is also determined by other factors, such as driving style, road conditions, maintenance or environmental factors.

## Switch off any functions that are not currently needed

Functions such as seat heating and the rear window defroster require a lot of energy and reduce the range, especially in city and stop-and-go traffic.

Therefore, switch off these functions if they are not actually needed.

The ECO PRO driving program supports the energy conserving use of comfort functions. These functions are automatically deactivated partially or completely.

## Have maintenance carried out

Have vehicles maintained regularly to achieve optimal vehicle economy and operating life. The maintenance should be carried out by your service center.

Also note the BMW Maintenance System, refer to page 229.

## ECO PRO

### The concept

ECO PRO supports a driving style that saves on fuel consumption. For this purpose, the engine control and comfort functions, e. g. the climate control output, are adjusted.

In the instrument display, the extension of the range achieved by this can be displayed as a bonus range.

### At a glance

The system includes the following EfficientDynamics functions and displays:

- ▷ ECO PRO bonus range, refer to page 199.
- ▷ ECO PRO climate control, refer to page 199.

### Activate ECO PRO



Press button repeatedly until ECO PRO is displayed in the instrument cluster.

### Configuring ECO PRO

#### Via the Driving Dynamics Control

1. Activate ECO PRO.
2. "Configure ECO PRO"
3. Configure the program.

## Via the iDrive

1. "Settings"
2. "ECO PRO mode"

Or

1. "Settings"
2. "Driving mode"
3. "Configure ECO PRO"

Configure the program.

## ECO PRO Tip

- "Tip at:":  
Set ECO Pro speed at which an ECO PRO Tip is to be displayed.
- "ECO PRO speed warning":  
A reminder is displayed if the set ECO PRO speed is exceeded.

## ECO PRO climate control

"ECO PRO climate control"

The climate control is adjusted to be fuel-efficient.

By making a slight change to the set temperature, or slowly adjusting the rate of heating or cooling of the passenger compartment, fuel consumption can be economized.

The outputs of the seat heater and the exterior mirror heating are also reduced.

The exterior mirror heating is made available when outside temperatures are very cold.

## ECO PRO potential

The percentage of potential savings that can be achieved with the current configuration is displayed.

## Display in the instrument cluster

### ECO PRO bonus range

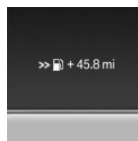

An extension of the range can be achieved by an adjusted driving style.

This may be displayed as the bonus range in the instrument

cluster.

The bonus range is shown in the range display.

The bonus range is automatically reset every time the vehicle is refueled.

### ECO PRO Tip - driving instruction

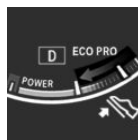

The arrow indicates that the driving style can be adjusted to be more fuel efficient by backing off the accelerator for instance.

## Note

The driving style display and ECO PRO tips in the instrument cluster appear when the ECO PRO display is activated.

Activating driving style and ECO PRO tips:

1. "Settings"
2. "Info display"
3. "ECO PRO Info"

### ECO PRO tip - Symbols

An additional symbol and a text instruction are displayed.

## Symbol Measure



For efficient driving style, back off the accelerator or delay accelerating to allow time to assess road conditions.



Reduce speed to the selected ECO PRO speed.



Automatic transmission: switch from M/S to D and avoid manual shift interventions.

## Indications on the Control Display

### EfficientDynamics

Information on fuel consumption and technology can be displayed during driving.

1. "Vehicle Info"
2. "EfficientDynamics"

### Displaying EfficientDynamics info

The current efficiency can be displayed.

 "EfficientDynamics info"

The following systems are displayed:

- ▷ Automatic engine start-stop function.
- ▷ Energy recovery.
- ▷ Climate control output.
- ▷ Coasting.

### Display ECO PRO tips

 "ECO PRO Tips"

The setting is stored for the profile currently in use.

## Coasting

### The concept

The system helps to conserve fuel.

To do this, under certain conditions the engine is automatically decoupled from the transmis-

sion when transmission position D is engaged. The vehicle continues traveling with the engine idling to reduce fuel consumption. Transmission position D remains engaged.

This driving condition is referred to as coasting.

As soon as the brake or accelerator pedal is depressed, the engine is automatically coupled to the transmission again.

### Hints

Coasting is a component of the ECO PRO, refer to page 198, driving mode.

Coasting is automatically activated when ECO PRO mode is called via the Driving Dynamics Control.

The function is available in a certain speed range.

A forward-looking driving style helps the driver to use the function as often as possible and supports the fuel-conserving effect of coasting.

### Safety mode

The function is not available if one of the following conditions is satisfied.

- ▷ DSC OFF or TRACTION activated.
- ▷ Driving in the dynamic limit range and on steep uphill or downhill grades.
- ▷ Battery charge status temporarily too low or vehicle electrical system drawing excessive current.
- ▷ Cruise control activated.

### Functional requirements

In ECO PRO mode, this function is available in a speed range from approximately 30 mph, approx. 50 km/h to 100 mph, approx. 160 km/h, if the following conditions are satisfied:

- ▷ Accelerator pedal and brake pedal are not operated.



- ▶ The selector lever is in transmission position D.
- ▶ Engine and transmission are at operating temperature.

## Display

### Indications on the Control Display

The Coasting driving condition is displayed in EfficientDynamics Info while this driving mode is active.

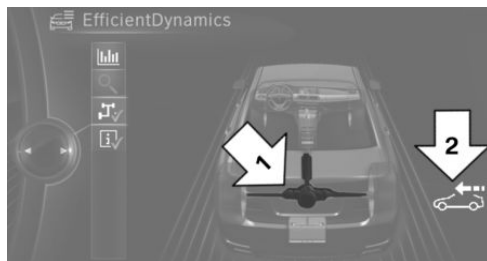

Color code blue, arrow 1, and symbol, arrow 2: driving condition Coasting.

### Displaying EfficientDynamics info

1. "Vehicle Info"
2. "EfficientDynamics"
3.  "EfficientDynamics info"

### Deactivating the system manually

The function can be deactivated in the Configure ECO PRO, refer to page 198, menu, e.g., to use the braking effect of the engine when traveling downhill.

The setting is stored for the profile currently in use.





## Mobility

In order to always ensure your mobility, you will find important information on operating fluids, wheels and tires, maintenance and Roadside Assistance in the following.

# Refueling

## Vehicle equipment

All standard, country-specific and optional equipment that is offered in the model series is described in this chapter. Therefore, equipment is also described that is not available in a vehicle, e. g., because of the selected optional equipment or country variant. This also applies for safety-related functions and systems.

## Hints



Refuel promptly

Refuel no later than at a range of 30 miles/50 km, or operation of the engine is not ensured and damage may occur. ◀

## Diesel engines

The filler neck is designed for refueling at diesel fuel pumps.

## Fuel cap

### Opening

1. Briefly press the rear edge of the fuel filler flap.



2. Turn the fuel cap counterclockwise.

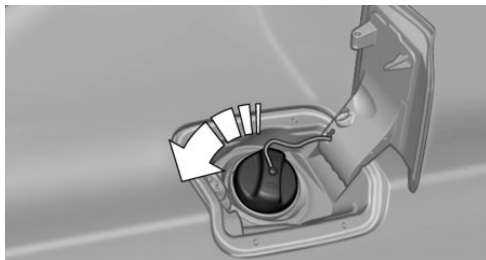

3. Place the fuel cap in the bracket attached to the fuel filler flap.

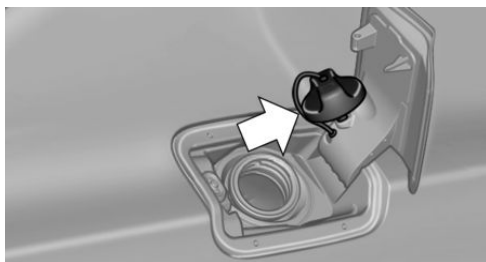

### Closing

1. Fit the cap and turn it clockwise until you clearly hear a click.
2. Close the fuel filler flap.



Do not pinch the retaining strap

Do not pinch the retaining strap attached to the cap; otherwise, the cap cannot be closed properly and fuel vapors can escape. ◀

### Manually unlocking fuel filler flap

In the event of an electrical malfunction, for example.

1. Open the cover on the right side trim.

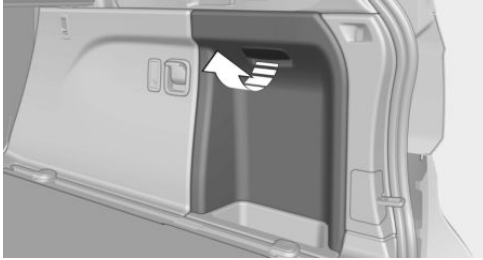

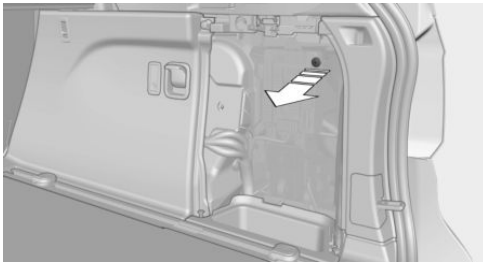

2. Pull the green knob with the fuel pump symbol. This releases the fuel filler flap.



## Observe the following when refueling

The fuel tank is full when the filler nozzle clicks off the first time.

 Do not overfill the fuel tank  
Do not overfill the fuel tank; otherwise fuel may escape, causing harm to the environment and damaging the vehicle.◀

 Handling fuels  
Obey safety regulations posted at the gas station.◀

# Fuel

## Vehicle equipment

All standard, country-specific and optional equipment that is offered in the model series is described in this chapter. Therefore, equipment is also described that is not available in a vehicle, e. g., because of the selected optional equipment or country variant. This also applies for safety-related functions and systems.

## Fuel recommendation

### Note



#### General fuel quality

Even fuels that conform to the specifications can be of low quality. Switch gas stations or use fuel from brand name producers having a higher octane level; otherwise, engine problems, such as poor engine starting performance, poorer handling characteristics or driving performance may occur. ◀

### Gasoline

For the best fuel economy, the gasoline should be sulfur-free or very low in sulfur content.

Fuels that are marked on the gas pump as containing metal must not be used.



Refuel only with unleaded gasoline without metallic additives.

Do not refuel with any leaded gasoline or gasoline with metallic additives, e. g. manganese or iron, or permanent damage to the catalytic converter and other components. ◀

Fuels with a maximum ethanol content of 10 %, i. e., E10, may be used for refueling.

Ethanol should satisfy the following quality standards:

US: ASTM 4806-xx

CAN: CGSB-3.511-xx

xx: comply with the current standard in each case.



Do not refuel with Ethanol above the maximum Ethanol proportion

Do not refuel with Ethanol above the maximum Ethanol proportion, that is, refueling with fuel that contains more than 10 % Ethanol, flex fuel or other alcohols; otherwise, damage to the engine and fuel supply could result. ◀

### Gasoline quality

BMW recommends AKI 91.

### Minimum fuel grade

BMW recommends AKI 89.



#### Minimum fuel grade

Do not use any gasoline below the minimum fuel grade as this may impair engine performance. ◀

If you use gasoline with this minimum AKI Rating, the engine may produce knocking sounds when starting at high outside temperatures. This has no effect on the engine life.



#### Fuel quality

The use of poor-quality fuels may result in harmful engine deposits or damage. Additionally, problems relating to drivability, starting and stalling, especially under certain environmental conditions such as high ambient temperature and high altitude, may occur.

If drivability problems are encountered, we recommend switching to a high quality gasoline brand and a higher octane grade — AKI number — for a few tank fills. To avoid harmful engine deposits, it is highly recommended to purchase gasoline from BP or Top Tier retailers.

Failure to comply with these recommendations may result in the need for unscheduled maintenance. ◀

## Diesel

### Low-Sulfur Diesel

The engine of your BMW is designed for diesel with low sulfur content:

Ultra-Low Sulfur Diesel ASTM D 975-xx.

xx: comply with the current standard in each case.



Use only Ultra-Low Sulfur Diesel.

The fraction of biodiesel in the fuel must not exceed 5 %, referred to as B5. Do not use gasoline. If you do fill the tank with the wrong fuel, e.g., gasoline, do not start the engine as this may damage the engine. ◀

After adding the wrong fuel, contact your service center or roadside assistance.

If the fuel pump nozzle does not fit in the filler pipe of your BMW, please check to ensure that you are refueling at a diesel fuel pump that is equipped with a diesel fuel pump nozzle.

In the event the Ultra-Low Sulfur Diesel fuel cannot be fully inserted into the fuel filler neck, please contact BMW Roadside Assistance for instructions on how to add fuel. For more information on BMW Roadside Assistance, refer to page 240.

### Winter diesel

To ensure that the diesel engine remains operational in the winter, use winter diesel.

It is available at gas stations during winter months.

The fuel filter heating system, included as a standard feature, prevents disruption of the fuel supply while driving.



Do not add any diesel additives

Do not add additives, including gasoline; otherwise, engine damage may occur. ◀

BMW recommends BP fuels 

## BMW Advanced Diesel

### The concept

BMW Advanced Diesel reduces nitrogen oxides in the diesel emissions by injecting diesel exhaust fluid reducing agent into the exhaust system. A chemical reaction takes place inside the catalytic converter that minimizes nitrogen oxides.

The vehicle has two tanks, the active tank and the passive tank. The active tank can be refilled in the engine compartment. The passive tank is refilled by the service center.

To be able to start the engine as usual, there must be an adequate reducing agent.

### Warming up the system

In order to warm the engine up to its operating temperature after a cold start, the automatic transmission may subsequently shift up to the next higher gear.

### Displays in the instrument cluster

#### Reserve display

This display in the instrument cluster provides information about the distance that can still be driven with the current reserve level.

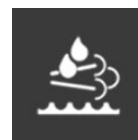

The reserve indication is displayed starting at approx. 600 miles/1,000 km remaining range.



### Refill in good time

The reducing agent must be replenished as soon as the Reserve display appears, otherwise the engine cannot be restarted. ◀

### Diesel exhaust fluid on minimum



The engine will continue to run even when the display shows --, as long as it is not switched off and all other operating conditions are satisfied, sufficient fuel

for example.



### Engine does not start

Do not continue driving to the limit of the remaining travel distance. Otherwise, you will not be able to restart the engine after switching it off. ◀

### Filling with incorrect fuel

A Check Control message is displayed when the tank is filled with the incorrect fuel.

After adding the wrong fuel, contact your service center.

### System defect

A Check Control message is displayed when there is a system defect.

### Have the diesel exhaust fluid replenished

The reducing agent is added by the service center within the context of regular maintenance. Provided you observe this maintenance schedule, it is normally necessary to replenish the fluid once between maintenance appointments.

It may be necessary to have the fluid replenished several times under particular circumstances, for example, if the vehicle is driven in a particularly sporty style or if it is driven at high altitudes.

The reducing agent must be replenished as soon as the reserve display appears in the instrument cluster to avoid not being able to restart the engine.

### Diesel exhaust fluid at low temperatures

Due to its physical properties, it is possible that reducing agent may also need to be replenished between regular maintenance appointments if it is exposed to temperatures below + 23 °F/- 5 °C. In this case, add reducing agent only immediately before starting to drive.

The need to replenish it is indicated by the Reserve display in the instrument cluster.

At temperatures below + 12 °F/- 11 °C the fill level in some cases cannot be measured.

After adding reducing agent, the reserve display is displayed only until the fill level can be measured again.

### Replenishing Diesel exhaust fluid yourself in exceptional cases

You can replenish reducing agent yourself in exceptional cases, e.g., to get to the service center.



Avoid contact with Diesel exhaust fluid

Do not come into contact with the reducing agent. Otherwise, skin or eye irritations may result. ◀



Handling Diesel exhaust fluid

When working with reducing agent in closed spaces, ensure good ventilation. When the bottle or container is opened, acrid smelling fumes may escape. ◀



Keeping Diesel exhaust fluid out of reach of children

Keep reducing agent out of reach of children ◀



Avoid contact with surfaces

Avoid contact of reducing agent with surfaces of the vehicle. Damage could result. ◀



## Suitable Diesel exhaust fluid

- ▶ Preferred: BMW Diesel Exhaust Fluid. With this bottle and its special adapter, Diesel exhaust fluid can be replenished simply and safely.
- ▶ Alternative: NOx reduction agent AUS 32 Diesel exhaust fluid can be purchased at your Service Center.

## Refill quantity

When the Reserve display starts, add at least 2 bottles of reducing agent. This corresponds to approx. 1 gallon.

## Tank for reducing agent

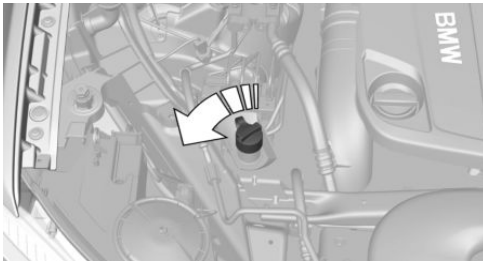

The tank for the reducing agent is located in the engine compartment.

## Adding

1. Open the hood, refer to page 222.
2. Turn the fuel cap counterclockwise and remove.
3. Place the bottle on it and turn it as far as it will go, see arrow.

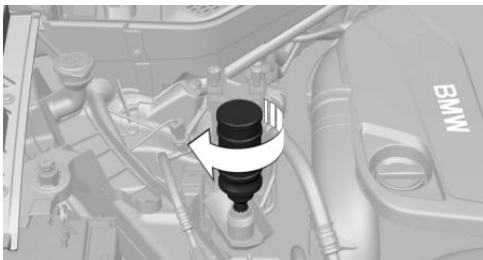

4. Press the bottle down, see arrow. The vehicle container will be filled. The container is full when the fill level in the bottle no longer changes. It is not possible to overfill.

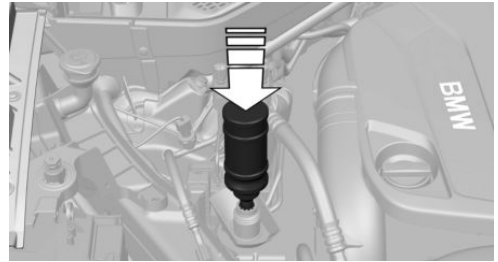

5. Pull back the bottle, see arrow, and unscrew it.

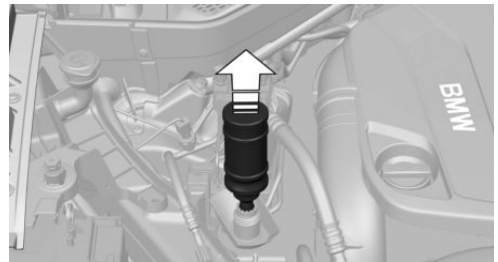

6. Replace the fuel cap and turn it clockwise.
7. Close the hood.

## After adding Diesel exhaust fluid

### Note

 Incorrect fluids  
After filling with incorrect fluids, such as antifreeze for washer water, do not start the engine, otherwise there is risk of fire. ◀

Contact your service center.

## Disposing of bottles



You take your empty Diesel exhaust fluid bottles to your Service Center for disposal.

Do not dispose of empty bottles with household waste unless this is permitted by local regulations.

### Reserve display



The Reserve display will still appear along with the remaining range after refilling.

Engine can be started.

After several minutes of driving, the Reserve indication goes out.

### Diesel exhaust fluid on minimum



After filling, the indication -- is still displayed.

Only after the display goes out can the engine -- be started.

1. Switch on the ignition.  
Display -- goes out after approx. 1 minute.
2. Engine can be started.

# Wheels and tires

## Vehicle equipment

All standard, country-specific and optional equipment that is offered in the model series is described in this chapter. Therefore, equipment is also described that is not available in a vehicle, e. g., because of the selected optional equipment or country variant. This also applies for safety-related functions and systems.

## Tire inflation pressure

### Safety information

The tire characteristics and tire inflation pressure influence the following:

- ▷ The service life of the tires.
- ▷ Road safety.
- ▷ Driving comfort.

### Checking the pressure

Tires have a natural, consistent loss of pressure.

 Check the tire inflation pressure regularly. Regularly check the tire inflation pressure, and correct it as needed: at least twice a month and before a long trip. If you fail to observe this precaution, you may be driving on tires with incorrect tire pressures, a condition that may not only compromise your vehicle's driving stability, but also lead to tire damage and the risk of an accident. ◀

Tires heat up during driving, and the tire inflation pressure increases along with the temperature of the tire. The tire inflation pressure specifications relate to cold tires or tires with the ambient temperature.

Only check the tire inflation pressure when the tires are cold. This means after driving no more

than 1.25 miles/2 km or when the vehicle has been parked for at least 2 hours.

After correcting the tire inflation pressure:

- ▷ Reinitialize the Flat Tire Monitor.
- ▷ Reinitialize the Tire Pressure Monitor.

### Pressure specifications

The tire inflation pressure table, refer to page 212, contains all pressure specifications for the specified tire sizes at the ambient temperature. Pressure specifications apply to approved tire sizes and recommended tire brands. This information can be obtained from your service center.

To identify the correct tire inflation pressure, please note the following:

- ▷ Tire sizes of your vehicle.
- ▷ Maximum permitted driving speed.

### Tire inflation pressures up to 100 mph/160 km/h

For speeds of up to 100 mph/160 km/h and for optimum driving comfort, note the pressure values in the tire inflation pressure table, refer to page 212, and adjust as necessary.



These pressure values can also be found on the tire inflation pressure label on the driver's door pillar.



**Maximum permissible speed**

Do not exceed 100 mph/160 km/h; otherwise, tire damage and accidents may result. ◀

**Tire inflation pressure values up to 100 mph/160 km/h**

**X5 sDrive35i/X5 xDrive35i/  
X5 xDrive50i/X5 xDrive35d with two rows of seats**

Tire size	Pressure specifications in bar/PSI
-----------	------------------------------------

Specifications in bar/PSI with cold tires

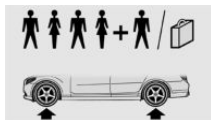

255/55 R 18 109 H M+S XL A/S RSC	2.3 / 33	2.8 / 41
----------------------------------	----------	----------

255/55 R 18 109 H M+S XL RSC		
------------------------------	--	--

255/50 R 19 107 H M+S XL A/S RSC	2.5 / 36	3.0 / 44
----------------------------------	----------	----------

255/50 R 19 107 H M+S XL RSC		
------------------------------	--	--

Front: 275/40 R 20 106 W XL RSC	2.5 / 36	-
	-	2.8 / 41

Rear: 315/35 R 20 110 W XL RSC		
--------------------------------	--	--

Front: 275/40 R 20 106 V M+S XL RSC	2.5 / 36	-
	-	2.8 / 41

Rear: 315/35 R 20 110 V M+S XL RSC		
------------------------------------	--	--

Tire size	Pressure specifications in bar/PSI
-----------	------------------------------------

Front: 285/35 R 21 105 Y XL RSC	2.5 / 36	-
	-	3.0 / 44

Rear: 325/30 R 21 108 Y XL RSC		
--------------------------------	--	--

Compact wheel: T 155/90 D 18 113 M	Speed up to a max. of 50 mph / 80 km/h	
	4.2 / 60	

T 155/80 R 19 114 M		
---------------------	--	--

**X5 sDrive35i/X5 xDrive35i/  
X5 xDrive50i/X5 xDrive35d with three rows of seats**

Tire size	Pressure specifications in bar/PSI
-----------	------------------------------------

Specifications in bar/PSI with cold tires

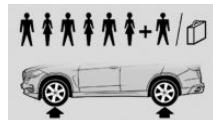

255/55 R 18 109 H M+S XL A/S RSC	2.2 / 32	2.7 / 39
----------------------------------	----------	----------

255/55 R 18 109 H M+S XL RSC		
------------------------------	--	--

255/50 R 19 107 H M+S XL A/S RSC	2.4 / 35	2.9 / 42
----------------------------------	----------	----------

255/50 R 19 107 H M+S XL RSC		
------------------------------	--	--

Front: 275/40 R 20 106 W XL RSC	2.4 / 35	-
	-	2.7 / 39

Rear: 315/35 R 20 110 W XL RSC		
--------------------------------	--	--

Tire size	Pressure specifications in bar/PSI	
Front: 275/40 R 20 106 V M+S XL RSC	2.4 / 35	- 2.7 / 39
Rear: 315/35 R 20 110 V M+S XL RSC		
Front: 285/35 R 21 105 Y XL RSC	2.4 / 35	- 2.9 / 42
Rear: 325/30 R 21 108 Y XL RSC		

### Tire inflation pressures at max. speeds above 100 mph/160 km/h

 Speeds above 100 mph/160 km/h  
In order to drive at maximum speeds in excess of 100 mph/160 km/h, please observe, and, if necessary, adjust tire pressures for speeds exceeding 100 mph/160 km/h from the relevant table on the following pages. Otherwise tire damage and accidents could occur. ◀

### Tire inflation pressure values over 100 mph/160 km/h

#### X5 sDrive35i/X5 xDrive35i/ X5 xDrive35d with two rows of seats

Without Sport Package

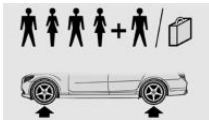
Tire size	Pressure specifications in bar/PSI	
Specifications in bar/PSI with cold tires		
255/55 R 18 109 H M+S XL A/S RSC	2.6 / 38	3.1 / 45
255/55 R 18 109 H M+S XL RSC		

Tire size	Pressure specifications in bar/PSI	
255/50 R 19 107 H M+S XL A/S RSC	2.8 / 41	3.3 / 48
255/50 R 19 107 H M+S XL RSC		
Front: 275/40 R 20 106 W XL RSC	2.8 / 41	- 3.0 / 44
Rear: 315/35 R 20 110 W XL RSC		
Front: 275/40 R 20 106 V M+S XL RSC	2.8 / 41	- 3.0 / 44
Rear: 315/35 R 20 110 V M+S XL RSC		
Front: 285/35 R 21 105 Y XL RSC	2.8 / 41	- 3.2 / 46
Rear: 325/30 R 21 108 Y XL RSC		
Compact wheel: T 155/90 D 18 113 M	Speed up to a max. of 50 mph / 80 km/h	4.2 / 60
T 155/80 R 19 114 M		

With Sport Package

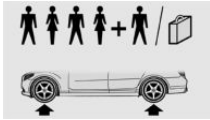
Tire size	Pressure specifications in bar/PSI	
Specifications in bar/PSI with cold tires		
255/55 R 18 109 H M+S XL RSC	2.9 / 42	3.4 / 49
255/50 R 19 107 H M+S XL RSC		

Tire size	Pressure specifications in bar/PSI	
Front: 275/40 R 20 106 W XL RSC	2.9 / 42	- 3.2 / 46
Rear: 315/35 R 20 110 W XL RSC		
Front: 275/40 R 20 106 V XL RSC	2.9 / 42	- 3.2 / 46
Rear: 315/35 R 20 110 V XL RSC		
Front: 285/35 R 21 105 Y XL RSC	2.9 / 42	- 3.4 / 49
Rear: 325/30 R 21 108 Y XL RSC		

Compact wheel: T 155/90 D 18 113 M	Speed up to a max. of 50 mph / 80 km/h 4.2 / 60
T 155/80 R 19 114 M	

### X5 sDrive35i/X5 xDrive35i/ X5 xDrive35d with three rows of seats

Without Sport Package

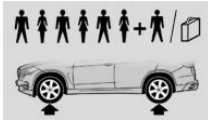
Tire size	Pressure specifications in bar/PSI	
Specifications in bar/PSI with cold tires		
255/55 R 18 109 H M+S XL A/S RSC	2.5 / 36	3.0 / 44
255/55 R 18 109 H M+S XL RSC		
255/50 R 19 107 H M+S XL A/S RSC	2.7 / 39	3.2 / 46
255/50 R 19 107 H M+S XL RSC		

Tire size	Pressure specifications in bar/PSI	
Front: 275/40 R 20 106 W XL RSC	2.7 / 39	- 3.0 / 44
Rear: 315/35 R 20 110 W XL RSC		
Front: 275/40 R 20 106 V M+S XL RSC	2.7 / 39	- 3.0 / 44
Rear: 315/35 R 20 110 V M+S XL RSC		
Front: 285/35 R 21 105 Y XL RSC	2.7 / 39	- 3.2 / 46
Rear: 325/30 R 21 108 Y XL RSC		

With Sport Package

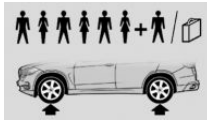
Tire size	Pressure specifications in bar/PSI	
Specifications in bar/PSI with cold tires		
255/55 R 18 109 H M+S XL RSC	2.9 / 42	3.4 / 49
255/50 R 19 107 H M+S XL RSC		
Front: 275/40 R 20 106 W XL RSC	2.9 / 42	- 3.2 / 46
Rear: 315/35 R 20 110 W XL RSC		
Front: 275/40 R 20 106 V M+S XL RSC	2.9 / 42	- 3.2 / 46
Rear: 315/35 R 20 110 V M+S XL RSC		
Front: 285/35 R 21 105 Y XL RSC	2.9 / 42	- 3.4 / 49
Rear: 325/30 R 21 108 Y XL RSC		

## X5 xDrive50i with two rows of seats

Without Sport Package

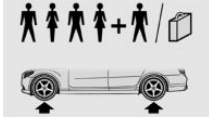
Tire size	Pressure specifications in bar/PSI	
Specifications in bar/PSI with cold tires		
255/55 R 18 109 H M+S XL A/S RSC	2.6 / 38	3.1 / 45
255/55 R 18 109 H M+S XL RSC		
255/50 R 19 107 H M+S XL A/S RSC	2.8 / 41	3.3 / 48
255/50 R 19 107 H M+S XL RSC		
Front: 275/40 R 20 106 W XL RSC	2.8 / 41	-
Rear: 315/35 R 20 110 W XL RSC	-	3.0 / 44
Front: 275/40 R 20 106 V M+S XL RSC	2.8 / 41	-
Rear: 315/35 R 20 110 V M+S XL RSC	-	3.0 / 44
Front: 285/35 R 21 105 Y XL RSC	2.8 / 41	-
Rear: 325/30 R 21 108 YW XL RSC	-	3.2 / 46
Compact wheel: T 155/90 D 18 113 M	Speed up to a max. of 50 mph / 80 km/h	
T 155/80 R 19 114 M	4.2 / 60	

With Sport Package

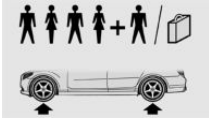
Tire size	Pressure specifications in bar/PSI	
Specifications in bar/PSI with cold tires		
255/55 R 18 109 H M+S XL RSC	2.9 / 42	3.4 / 49
255/50 R 19 107 H M+S XL RSC		
Front: 275/40 R 20 106 W XL RSC	2.9 / 42	-
Rear: 315/35 R 20 110 W XL RSC	-	3.4 / 49
Front: 275/40 R 20 106 V M+S XL RSC	2.9 / 42	-
Rear: 315/35 R 20 110 V M+S XL RSC	-	3.4 / 49
Front: 285/35 R 21 105 Y XL RSC	2.9 / 42	-
Rear: 325/30 R 21 108 Y XL RSC	-	3.2 / 46
Compact wheel: T 155/90 D 18 113 M	Speed up to a max. of 50 mph / 80 km/h	
T 155/80 R 19 114 M	4.2 / 60	

## X5 xDrive50i with three rows of seats

Without Sport Package

Tire size	Pressure specifications in bar/PSI	
-----------	------------------------------------	--

Specifications in bar/PSI with cold tires

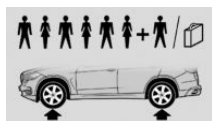

255/55 R 18 109 H M+S XL A/S RSC	2.5 / 36	3.0 / 44
----------------------------------	----------	----------

255/55 R 18 109 H M+S XL RSC		
------------------------------	--	--

255/50 R 19 107 H M+S XL A/S RSC	2.7 / 39	3.2 / 46
----------------------------------	----------	----------

255/50 R 19 107 H M+S XL RSC		
------------------------------	--	--

Front: 275/40 R 20 106 W XL RSC	2.7 / 39	-
Rear: 315/35 R 20 110 W XL RSC	-	3.0 / 44

Front: 275/40 R 20 106 V M+S XL RSC	2.7 / 39	-
Rear: 315/35 R 20 110 V M+S XL RSC	-	3.0 / 44

Front: 285/35 R 21 105 W XL RSC	2.7 / 39	-
Rear: 325/30 R 21 108 W XL RSC	-	3.2 / 46

With Sport Package

Tire size	Pressure specifications in bar/PSI	
-----------	------------------------------------	--

Specifications in bar/PSI with cold tires

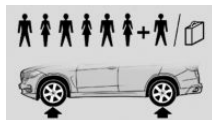

255/55 R 18 109 H M+S XL RSC	2.9 / 42	3.4 / 49
------------------------------	----------	----------

255/50 R 19 107 H M+S XL RSC		
------------------------------	--	--

Tire size	Pressure specifications in bar/PSI	
-----------	------------------------------------	--

Front: 275/40 R 20 106 W XL RSC	2.9 / 42	-
Rear: 315/35 R 20 110 W XL RSC	-	3.4 / 49

Front: 275/40 R 20 106 V M+S XL RSC	2.9 / 42	-
Rear: 315/35 R 20 110 V M+S XL RSC	-	3.4 / 49

Front: 285/35 R 21 105 W XL RSC	2.9 / 42	-
Rear: 325/30 R 21 108 W XL RSC	-	3.2 / 46

## Tire identification marks

### Tire size

245/45 R 18 96 Y

245: nominal width in mm

45: aspect ratio in %

R: radial tire code

18: rim diameter in inches

96: load rating, not for ZR tires

Y: speed rating, before the R on ZR tires

### Speed letter

Q = up to 100 mph, 160 km/h

R = up to 106 mph, 170 km/h

S = up to 112 mph, 180 km/h

T = up to 118 mph, 190 km/h

H = up to 131 mph, 210 km/h

V = up to 150 mph, 240 km/h

W = up to 167 mph, 270 km/h

Y = up to 186 mph, 300 km/h

### Tire Identification Number

DOT code: DOT xxxx xxx 1013



xxxx: manufacturer code for the tire brand

xxx: tire size and tire design

1013: tire age

Tires with DOT codes meet the guidelines of the U.S. Department of Transportation.

## Tire age

DOT ... 1013: the tire was manufactured in the 10th week 2013.

## Recommendation

Regardless of wear, replace tires at least every 6 years.

## Uniform Tire Quality Grading

Quality grades can be found where applicable on the tire sidewall between tread shoulder and maximum section width.

For example: Treadwear 200; Traction AA; Temperature A

## DOT Quality Grades

Treadwear

Traction AA A B C

Temperature A B C

All passenger car tires must conform to Federal Safety Requirements in addition to these grades.

## Treadwear

The treadwear grade is a comparative rating based on the wear rate of the tire when tested under controlled conditions on a specified government test course. For example, a tire graded 150 would wear one and one-half, 1 g, times as well on the government course as a tire graded 100. The relative performance of tires depends upon the actual conditions of their use, however, and may depart significantly from the norm due to variations in driving habits, service practices and differences in road characteristics and climate.

## Traction

The traction grades, from highest to lowest, are AA, A, B, and C.

Those grades represent the tire's ability to stop on wet pavement as measured under controlled conditions on specified government test surfaces of asphalt and concrete. A tire marked C may have poor traction performance.

The traction grade assigned to this tire is based on straight-ahead braking traction tests, and does not include acceleration, cornering, hydroplaning, or peak traction characteristics.

## Temperature

The temperature grades are A, the highest, B, and C, representing the tire's resistance to the generation of heat and its ability to dissipate heat when tested under controlled conditions on a specified indoor laboratory test wheel. Sustained high temperature can cause the material of the tire to degenerate and reduce tire life, and excessive temperature can lead to sudden tire failure. The grade C corresponds to a level of performance which all passenger car tires must meet under the Federal Motor Vehicle Safety Standard No. 109. Grades Band A represent higher levels of performance on the laboratory test wheel than the minimum required by law.



Temperature grade for this tire

The temperature grade for this tire is established for a tire that is properly inflated and not overloaded. Excessive speed, underinflation, or excessive loading, either separately or in combination, can cause heat buildup and possible tire failure.

If necessary, have the vehicle towed. ◀

## RSC – Run-flat tires

Run-flat tires, refer to page 220, are labeled with a circular symbol containing the letters RSC marked on the sidewall.

## M+S

Winter and all-season tires with better cold weather performance than summer tires.

## Tire tread

### Summer tires

Do not drive with a tire tread depth of less than 0.12 in/3 mm.

There is an increased danger of hydroplaning if the tread depth is less than 0.12 in/3 mm.

### Winter tires

Do not drive with a tire tread depth of less than 0.16 in/4 mm.

Below a tread depth of 0.16 in/4 mm, tires are less suitable for winter operation.

### Minimum tread depth



Wear indicators are distributed around the tire's circumference and have the legally required minimum height of 0.063 in/1.6 mm.

They are marked on the side of the tire with TWI, Tread Wear Indicator.

## Tire damage

### General information

Inspect your tires often for damage, foreign objects lodged in the tread, and tread wear.

## Notes

Driving over rough or damaged road surfaces, as well as debris, curbs and other obstacles can cause serious damage to wheels, tires and suspension parts. This is more likely to occur with low-profile tires, which provide less cushioning between the wheel and the road. Be careful to avoid road hazards and reduce your speed, especially if your vehicle is equipped with low-profile tires.

Indications of tire damage or other vehicle defects:

- ▷ Unusual vibrations during driving.
- ▷ Unusual handling such as a strong tendency to pull to the left or right.

Damage can, e. g., be caused by driving over curbs, road damage, or similar things.



#### In case of tire damage

If there are indications of tire damage, reduce your speed immediately and have the wheels and tires checked right away; otherwise, there is the increased risk of an accident.

Drive carefully to the nearest service center. Have the vehicle towed or transported there. Otherwise, tire damage can become life threatening for vehicle occupants and also other road users. ◀



#### Repair of tire damage

For safety reasons, the manufacturer of your vehicle recommends that you do not have damaged tires repaired; they should be replaced. Otherwise, damage can occur as a result. ◀

## Changing wheels and tires

### Mounting



#### Information on mounting tires

Have mounting and balancing performed only by a service center.

If this work is not carried out properly, there is the danger of subsequent damage and related safety hazards. ◀

### Wheel and tire combination

You can ask the service center about the right wheel/tire combination and wheel rim versions for the vehicle.

Incorrect wheel and tire combinations impair the function of a variety of systems such as ABS or DSC.

To maintain good handling and vehicle response, use only tires with a single tread configuration from a single manufacturer.

Following tire damage, have the original wheel and tire combination remounted on the vehicle as soon as possible.



#### Approved wheels and tires

The manufacturer of your vehicle recommends that you use only wheels and tires that have been approved for your particular vehicle model.

For example, despite having the same official size ratings, variations can lead to body contact and with it, the risk of severe accidents.

The manufacturer of your vehicle cannot evaluate non-approved wheels and tires to determine if they are suited for use, and therefore cannot ensure the operating safety of the vehicle if they are mounted. ◀

### Recommended tire brands



For each tire size, the manufacturer of your vehicle recommends certain tire brands. These can be identified by a star on the tire sidewall.

With proper use, these tires meet the highest standards for safety and handling.

### New tires

Due to technical factors associated with their manufacture, tires do not achieve their full traction potential until after an initial breaking-in period.

Drive conservatively for the first 200 miles/300 km.

### Retreaded tires

The manufacturer of your vehicle does not recommend the use of retreaded tires.



#### Retreaded tires

Possibly substantial variations in the design and age of the tire casing structures can limit service life and have a negative impact on road safety. ◀

### Winter tires

Winter tires are recommended for operating on winter roads.

Although so-called all-season M+S tires do provide better winter traction than summer tires, they do not provide the same level of performance as winter tires.

### Maximum speed of winter tires

If the maximum speed of the vehicle is higher than the permissible speed for the winter tires, then display a corresponding sign in the field of vision. You can obtain this sign from the tire specialist or from your service center.



Maximum speed for winter tires

Do not exceed the maximum speed for the respective winter tires; otherwise, tire damage and accidents can occur. ◀

### Run-flat tires

If you are already using run-flat tires, for your own safety you should replace them only with the same kind. No spare tire is available in the case of a flat tire. Your service center will be glad to advise you.

### Rotating wheels between axles

The manufacturer of your vehicle advises against switching wheels between the front and rear axles.

This can impair the handling characteristics.

### Storage

Store wheels and tires in a cool, dry place with as little exposure to light as possible.

Always protect tires against all contact with oil, grease and fuels.

Do not exceed the maximum tire inflation pressure indicated on the side wall of the tire.

## Run-flat tires

### Label



RSC label on the tire sidewall.

The wheels are composed of special rims and tires that are self-supporting, to a limited degree.

The support of the sidewall allows the tire to remain drivable to a restricted degree in the event of a pressure loss.

Continued driving with a damaged tire, refer to page 112.

Continued driving with a damaged tire, refer to page 109.

### Changing run-flat tires

For your own safety, only use run-flat tires. No spare tire is available in the case of a flat tire. Your service center will be glad to advise you.

## Snow chains

### Fine-link snow chains

Only certain types of fine-link snow chains have been tested by the manufacturer of the vehicle, classified as road-safe and approved.

Information about the approved snow chains are available from the service center.

### Use

Use only in pairs on the rear wheels, equipped with the tires of the following size:

- ▷ 255/55 R 18.
- ▷ 255/50 R 19.

Follow the chain manufacturer's instructions.

Make sure that the snow chains are always sufficiently tight. Retighten as needed according to the chain manufacturer's instructions.

Do not initialize the Flat Tire Monitor after mounting snow chains, as doing so may result in incorrect readings.

Do not initialize the Tire Pressure Monitor after mounting snow chains, as doing so may result in incorrect readings.

When driving with snow chains, briefly activate Dynamic Traction Control if necessary.

### **Maximum speed with snow chains**

Do not exceed a speed of 30 mph/50 km/h when using snow chains.

# Engine compartment

## Vehicle equipment

All standard, country-specific and optional equipment that is offered in the model series is described in this chapter. Therefore, equip-

ment is also described that is not available in a vehicle, e. g., because of the selected optional equipment or country variant. This also applies for safety-related functions and systems.

## Important features in the engine compartment

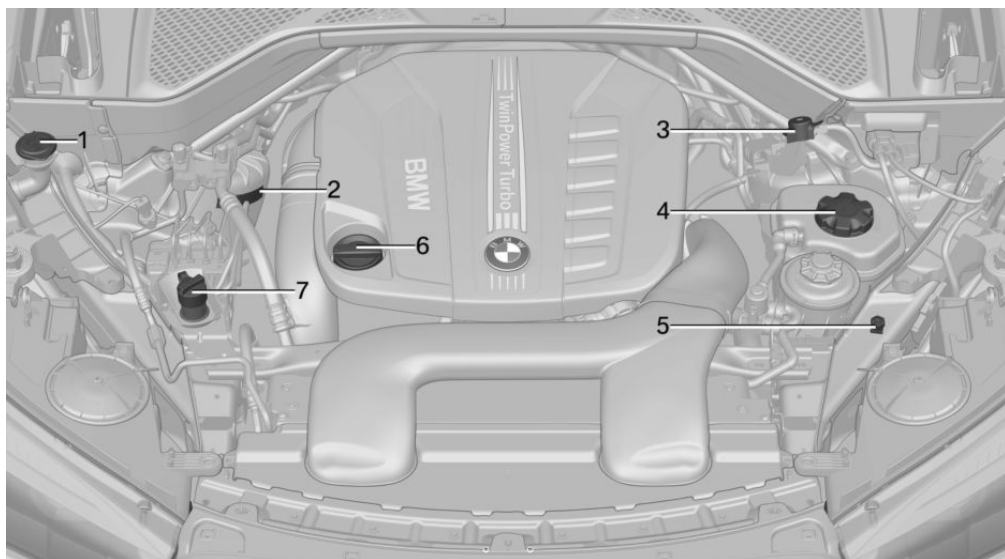

- |   |                                  |   |                                  |
|---|----------------------------------|---|----------------------------------|
| 1 | Washer fluid reservoir           | 5 | Jump-starting, negative terminal |
| 2 | Vehicle identification number    | 6 | Oil filler neck                  |
| 3 | Jump-starting, positive terminal | 7 | Container for reducing agent     |
| 4 | Coolant reservoir                |   |                                  |

## Hood

### Opening the hood

 Working in the engine compartment  
Never attempt to perform any service or repair operations on your vehicle without the necessary professional technical training.

If you are unfamiliar with the statutory guidelines, have any work on the vehicle performed only by a service center.

If this work is not carried out properly, there is the danger of subsequent damage and related safety hazards. ◀

 Never reach into the engine compartment

Never reach into the intermediate spaces or gaps in the engine compartment. Otherwise, there is risk of injury, e.g., from rotating or hot parts. ◀

1. Pull the lever.

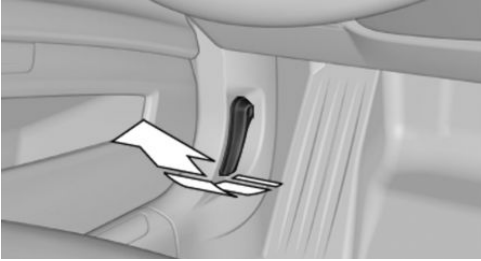

2. Press the release handle and open the hood.

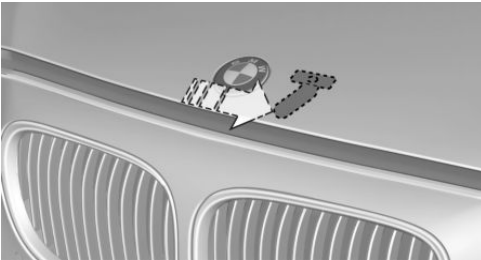

3. Be careful of protruding parts on the hood.



 Danger of injury when the hood is open  
There is a danger of injury from protruding parts when the hood is open. ◀

## Closing the hood

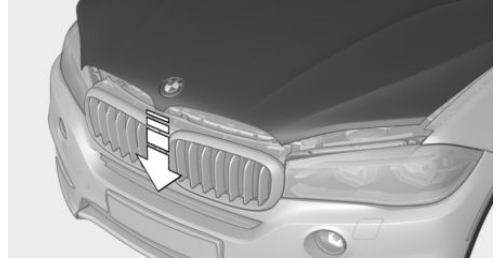

Let the hood drop from a height of approx. 16 in/40 cm and push down on it to lock it fully.

The hood must audibly engage on both sides.

 Hood open when driving

If you see any signs that the hood is not completely closed while driving, pull over immediately and close it securely. ◀

 Danger of pinching

Make sure that the closing path of the hood is clear; otherwise, injuries may result. ◀

# Engine oil

## Vehicle equipment

All standard, country-specific and optional equipment that is offered in the model series is described in this chapter. Therefore, equipment is also described that is not available in a vehicle, e. g., because of the selected optional equipment or country variant. This also applies for safety-related functions and systems.

## General information

The engine oil consumption is dependent on the driving style and driving conditions. When a sporty driving style is used, the engine oil consumption, for example, is clearly higher.

Therefore, regularly check the engine oil level after refueling.

The vehicle is equipped with electronic oil measurement.

The electronic oil measurement has two measuring principles.

- ▷ Status display
- ▷ Detailed measurement

## Checking the oil level electronically

### Status display

#### The concept

The oil level is monitored electronically during driving and shown on the Control Display.

If the oil level reaches the minimum level, a check control message is displayed.

#### Requirements

A current measured value is available after approx. 30 minutes of driving. During a shorter

trip, the status of the last, sufficiently long trip is displayed.

With frequent short-distance trips, regularly perform a detailed measurement.

### Displaying the oil level

1. "Vehicle Info"
2. "Vehicle status"
3.  "Engine oil level"

### Oil level display messages

Different messages appear on the display depending on the oil level. Pay attention to these messages.

If the engine oil level is too low, within the next 125 miles/200 km Add oil, refer to page 225.



Engine oil level too low

Add oil immediately; otherwise, an insufficient amount of engine oil could result in engine damage. ◀

Take care not to add too much engine oil.



Too much engine oil

Have the vehicle checked immediately; otherwise, surplus oil can lead to engine damage. ◀

### Detailed measurement

#### The concept

In the detailed measurement the oil level is checked and displayed via a scale.

Gasoline engine:

If the oil level reaches the minimum level, a check control message is displayed.

Diesel engine:

If the oil level reaches the minimum level or an overfilling is detected, a check control message is displayed.



During the measurement, the idle speed is increased somewhat.

## Requirements

- ▷ Vehicle is on level road.
- ▷ Automatic transmission: selector lever in transmission position N or P and accelerator pedal not depressed.
- ▷ Engine is running and is at operating temperature.

## Performing a detailed measurement

In order to perform a detailed measurement of the engine oil level:

1. "Vehicle Info"
2. "Vehicle status"
3.  "Measure engine oil level"
4. "Start measurement"

The oil level is checked and displayed via a scale.

Duration: approx. 1 minute.

## Adding engine oil

### General information

Switch off the ignition and safely park the vehicle before engine oil is added.

### Filler neck

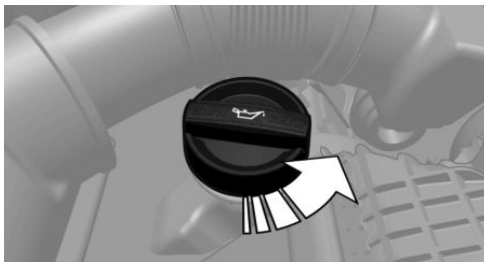

Only replenish the maximum oil amount of 1 US quart/liter if the signal is displayed in the instrument cluster.

After refilling, perform a detailed measurement, refer to page 224.



Adding oil

Add oil within the next 125 miles/200 km. Otherwise, the engine may be damaged. ◀



Do not add too much engine oil

When too much engine oil is added, immediately have the vehicle checked, otherwise, this may cause engine damage. ◀



Protect children

Keep oil, grease, etc., out of reach of children and heed the warnings on the containers to prevent health risks. ◀

## Oil types for refilling

### Hints



No oil additives

Oil additives may lead to engine damage. ◀



Viscosity grades for engine oils

When selecting an engine oil, ensure that the engine oil belongs to one of the viscosity grades SAE 0W-40, SAE 0W-30, SAE 5W-40, and SAE 5W-30 or malfunctions or engine damage may occur. ◀

The engine oil quality is critical for the life of the engine.

Some types of oils in some cases are not available in all countries.

### Approved oil types

Gasoline engine

BMW Longlife-01.

BMW Longlife-01 FE.

### Diesel engine

BMW Longlife-04.

---

Additional information about the approved types of oils can be requested from the service center.

### Alternative oil types

If the approved engine oils are not available, up to 1 US quart/liter of an oil with the following specification can be added:

#### Gasoline engine

API SM or superior grade specification.

---

#### Diesel engine

API ILSAC GF-5.

---

## Engine oil change

The manufacturer of your vehicle recommends having the engine oil changed by your service center.

**BMW recommends** 

# Coolant

## Vehicle equipment

All standard, country-specific and optional equipment that is offered in the model series is described in this chapter. Therefore, equipment is also described that is not available in a vehicle, e. g., because of the selected optional equipment or country variant. This also applies for safety-related functions and systems.

## Hints

 **Danger of burns from hot engine**  
Do not open the cooling system while the engine is hot; otherwise, escaping coolant may cause burns. ◀

 **Suitable additives**  
Only use suitable additives; otherwise, engine damage may occur. The additives are harmful to your health. ◀

Coolant consists of water and additives. Not all commercially available additives are suitable for the vehicle. Information about the suitable additives are available from the service center.

## Coolant level

If there is no Min. and Max. mark in the filler neck of the coolant reservoir, have the coolant level checked if necessary by your service center and add coolant as needed.

## Checking

1. Let the engine cool.
2. Turn the cap of the coolant reservoir slightly counterclockwise to allow any ex-

cess pressure to dissipate, and then open it.

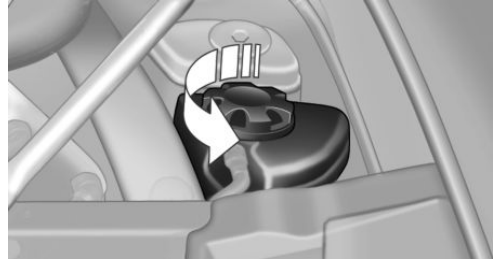

3. The coolant level is correct if it lies between the minimum and maximum marks in the filler neck.



## Filling

1. Let the engine cool.
2. Turn the cap of the coolant reservoir slightly counterclockwise to allow any excess pressure to dissipate, and then open it.

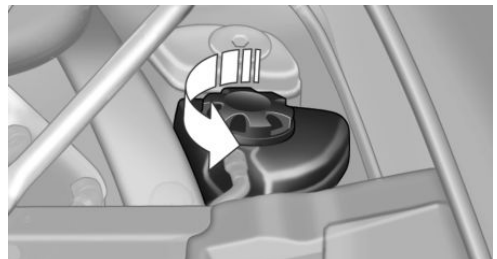

3. If the coolant is low, slowly add coolant up to the specified level; do not overfill.
4. Turn the cap until there is an audible click. The arrows on the coolant reservoir and the cap must point towards one another.
5. Have the cause of the coolant loss eliminated as soon as possible.

## Disposal



Comply with the relevant environmental protection regulations when disposing of coolant and coolant additives.

# Maintenance

## Vehicle equipment

All standard, country-specific and optional equipment that is offered in the model series is described in this chapter. Therefore, equipment is also described that is not available in a vehicle, e. g., because of the selected optional equipment or country variant. This also applies for safety-related functions and systems.

## BMW maintenance system

The maintenance system indicates required maintenance measures, and thereby provides support in maintaining road safety and the operational reliability of the vehicle.

## Condition Based Service CBS

Sensors and special algorithms take into account the driving conditions of your vehicle. Based on this, Condition Based Service determines the maintenance requirements.

The system makes it possible to adapt the amount of maintenance you need to your user profile.

Details on the service requirements, refer to page 90, can be displayed on the Control Display.

## Service data in the remote control

Information on the required maintenance is continuously stored in the remote control. Your service center will read out this data and suggest the right array of service procedures for your vehicle.

Therefore, hand your service specialist the remote control with which the vehicle was driven most recently.

## Storage periods

Storage periods during which the vehicle battery was disconnected are not taken into account.

If this occurs, have a service center update the time-dependent maintenance procedures, such as checking brake fluid and, if necessary, changing the engine oil and the microfilter/activated-charcoal filter.

## Service and Warranty Information Booklet for US models and Warranty and Service Guide Booklet for Canadian models

Please consult your Service and Warranty Information Booklet for US models and Warranty and Service Guide Booklet for Canadian models for additional information on service requirements.

Maintenance and repair should be performed by your service center. Make sure to have regular maintenance procedures recorded in the vehicle's Service and Warranty Information Booklet for US models, and in the Warranty and Service Guide Booklet for Canadian models. These entries are proof of regular maintenance.

## Socket for OBD Onboard Diagnosis

### Note



Socket for Onboard Diagnosis

The socket for onboard diagnostics may only be used by the service center or a workshop that operates in accordance with the specifications of the vehicle manufacturer with

correspondingly trained personnel and other authorized persons. Otherwise, use may result in operating problems for the vehicle. ◀

## Position

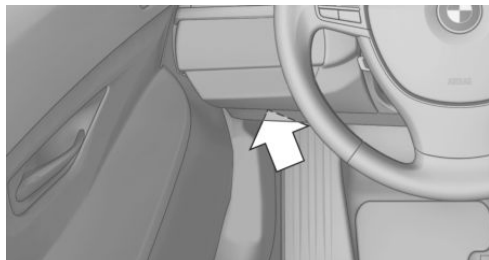

There is an OBD socket on the driver's side for checking the primary components in the vehicle emissions.

## Emissions



- ▶ The warning lamp lights up:  
Emissions are deteriorating. Have the vehicle checked as soon as possible.



Canadian model: warning light indicates the engine symbol.

- ▶ The warning lamp flashes under certain circumstances:  
This indicates that there is excessive misfiring in the engine.  
Reduce the vehicle speed and have the system checked immediately; otherwise, serious engine misfiring within a brief period can seriously damage emission control components, in particular the catalytic converter.

# Replacing components

## Vehicle equipment

All standard, country-specific and optional equipment that is offered in the model series is described in this chapter. Therefore, equipment is also described that is not available in a vehicle, e. g., because of the selected optional equipment or country variant. This also applies for safety-related functions and systems.

## Onboard vehicle tool kit

1. Raise the cargo floor panel.

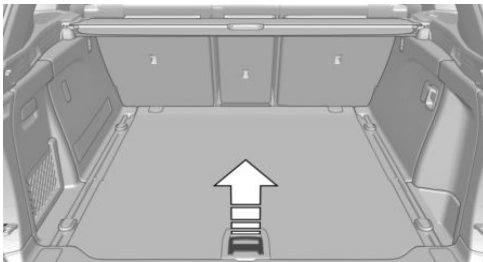

2. Remove the onboard vehicle tool kit.

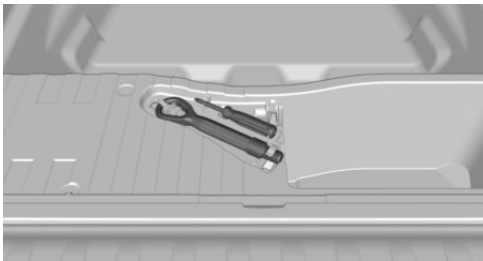

## Wiper blade replacement

### Hints



Do not fold down the wipers without wiper blades

Do not fold down the wipers if wiper blades have not been installed; this may damage the windshield. ◀



Folding down wipers before opening the hood

Before opening the hood, ensure that the wiper arms with the wiper blades are against the windshield to prevent damage. ◀

### Front: Replacing the wiper blades

1. To change the wiper blades, fold up, refer to page 77, the wiper arms.
2. Lift the wiper all the way off of the windshield.

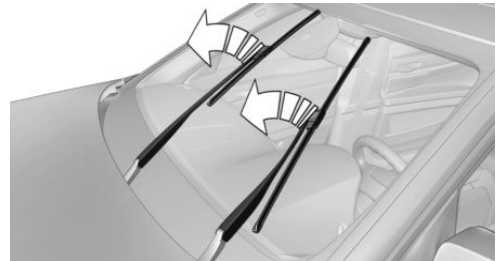

3. Fold open the holder.

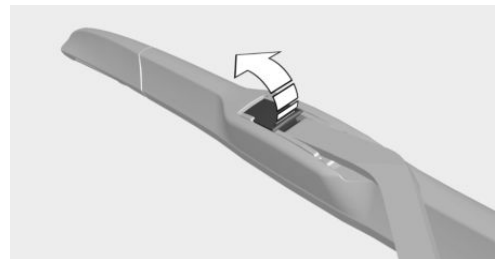

- Slide wiper blade out of the wiper arm.

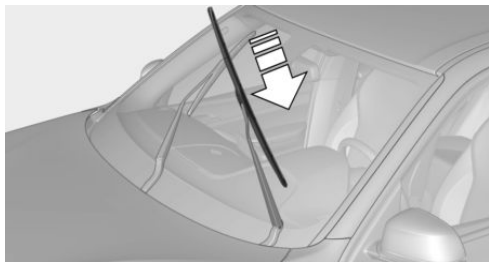

- Insert the new wiper blade and press it on until it you hear it snap into the holder.
- Fold down the wipers.

### Rear: replacing the wiper blades

- Lift off the wiper fully and pull off the wiper blade, arrow.

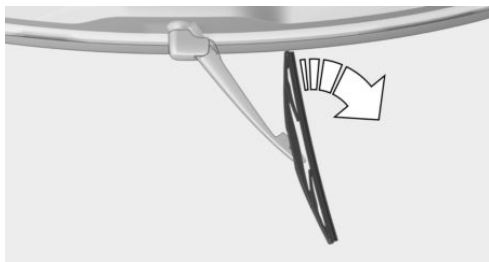

- Attach a new wiper blade. It must engage audibly.
- Fold down the wipers.

## Lamp and bulb replacement

### Hints

#### Lamps and bulbs

Lamps and bulbs make an essential contribution to vehicle safety.

The manufacturer of the vehicle recommends that you entrust corresponding procedures to the service center if you are unfamiliar with them or they are not described here.

You can obtain a selection of replacement bulbs at the service center.

**!** Danger of burns  
Only change bulbs when they are cool; otherwise, there is the danger of getting burned. ◀

**!** Working on the lighting system  
When working on the lighting system, you should always switch off the lights affected to prevent short circuits.

To avoid possible injury or equipment damage when replacing bulbs, observe any instructions provided by the bulb manufacturer. ◀

**!** Do not perform work/bulb replacement on xenon headlamps

Have any work on the xenon lighting system, including bulb replacement, performed only by a service center. Due to the high voltage present in the system, there is the danger of fatal injuries if work is carried out improperly. ◀

**!** Do not touch the bulbs  
Do not touch the glass of new bulbs with your bare hands, as even minute amounts of contamination will burn into the bulb's surface and reduce its service life.

Use a clean tissue, cloth or something similar, or hold the bulb by its base. ◀

### Light-emitting diodes (LEDs)

Light-emitting diodes installed behind a cover serve as the light source for controls, display elements and other equipment.

These light-emitting diodes, which are related to conventional lasers, are officially designated as Class 1 light-emitting diodes.

**!** Do not remove the covers  
Do not remove the covers, and never stare into the unfiltered light for several hours; otherwise, irritation of the retina could result. ◀



## Headlamp glass

Condensation can form on the inside of the external lamps in cool or humid weather. When driving with the light switched on, the condensation evaporates after a short time. The headlamp glasses do not need to be changed.

If the headlamps do not dim despite driving with the light switched on, increasing humidity forms, e. g. water droplets in the light, have the service center check this.

## Headlamp setting

The headlamp adjustments can be affected by changing lamps and bulbs. Therefore after a change, have the headlamp setting checked and corrected by Service.

## Front lamps, bulb replacement

### Xenon headlamps

#### Hints

Because of the long life of these bulbs, the likelihood of failure is very low. Switching the lamps on and off frequently shortens their life.

If a bulb fails, switch on the front fog lamps and continue the trip with great care. Comply with local regulations.

 Do not perform work/bulb replacement on xenon headlamps

Have any work on the xenon lighting system, including bulb replacement, performed only by a service center. Due to the high voltage present in the system, there is the danger of fatal injuries if work is carried out improperly. ◀

For checking and adjusting headlamp aim, please contact your BMW center.

### At a glance

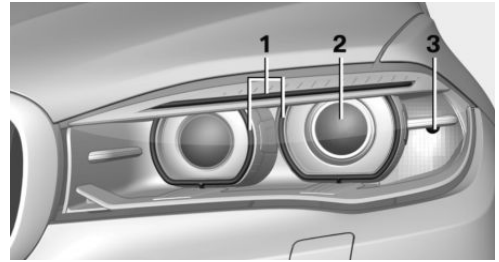

- 1 Parking lamps / daytime running lights
- 2 Low beams/high beams/headlamp flasher
- 3 Turn signal

### Xenon headlamps

Low beams and high beams are designed with xenon technology.

The parking lamps and daylight running lights are made using LED technology.

Contact your service center in the event of a malfunction.

### LED headlamps

#### Light-emitting diodes (LEDs)

Follow the general instructions on Lamps and bulbs, refer to page 232.

With LED headlamps, all front lamps and side indicators are designed with LED technology.

If an LED fails, switch on the front fog lamps and continue the trip with great care. Comply with local regulations.

Contact your service center in the event of a malfunction.

### Front fog lamps/cornering lamps

#### Note

Follow the general instructions on Lamps and bulbs, refer to page 232.

55-watt bulb, H11.

### Replacement

1. Insert the screwdriver from the onboard vehicle tool kit, with the flat side facing outward, past the removal hook and onto the clip, arrow 1.

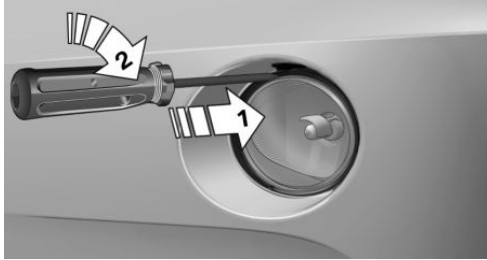

2. Turn the screwdriver by 90°, arrow 2.
3. Press the removal hook upward, arrow, and remove the front fog lamp from the front using the hook.



4. Detach the connector.

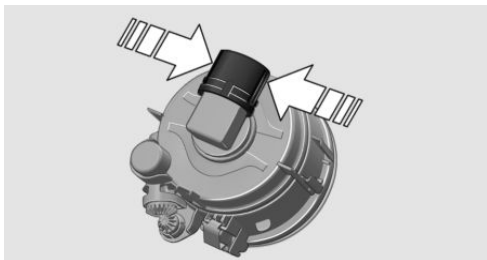

5. Turn the bulb bracket and remove it.

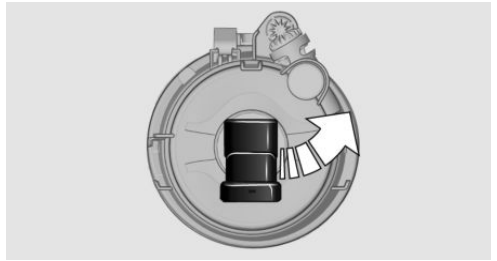

6. Remove the bulb and replace it.
7. Proceed in reverse order to insert the front fog lamp. Note the guide rails in doing so.

### LED front fog lamps

Follow the general instructions on Lamps and bulbs, refer to page 232.

These front fog lamps are made using LED technology. Contact your service center in the event of a malfunction.

### Turn signal

#### Note

Follow the general instructions on Lamps and bulbs, refer to page 232.

The turn signals are located next to each low beam in the engine compartment.

21-watt bulb, PY 21W.

### Replacement

1. Opening the hood, refer to page 222
2. Unscrew the cap counterclockwise and remove it carefully.

The bulb is attached to the cap.

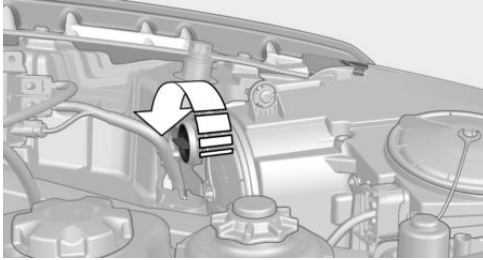

3. Turn the bulb clockwise to remove it.
4. Insert the new bulb and attach the cover in the reverse order.

### Lateral turn signals

Follow the general instructions on Lamps and bulbs, refer to page 232.

These lamps are made using LED technology. Contact your service center in the event of a malfunction.

### Tail lamps, bulb replacement

#### LED tail lamps

These tail lamps are made using LED technology. Contact your service center in the event of a malfunction.

## Changing wheels

### Hints

With three rows of seats, the vehicle equipment does not include a spare tire.

When using run-flat tires or tire sealants, a tire does not need to be changed immediately in the event of pressure loss due to a flat tire.

The tools for changing wheels are available as accessories from your service center.

## Jacking points for the vehicle jack

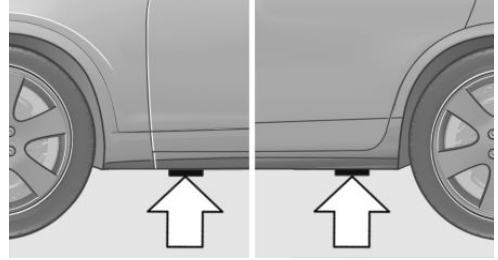

The jacking points for the vehicle jack are located at the positions shown.

## Compact wheel

### Hints

 Safety measures in case of a breakdown or a wheel change

- ▷ Park the vehicle as far away as possible from passing traffic and on solid ground. Switch on the hazard warning system.
- ▷ Set the parking brake and engage transmission position P.
- ▷ Have all vehicle occupants get out of the vehicle and ensure that they remain outside the immediate area in a safe place, such as behind a guardrail.
- ▷ If necessary, set up a warning triangle or portable hazard warning lamp at an appropriate distance. Comply with all safety guidelines and regulations.
- ▷ Perform wheel change only on a flat, solid and slip-resistant surface. On soft or slippery ground, e.g., snow, ice, tiles, etc., the vehicle or vehicle jack can slip away to the side.
- ▷ Do not place wood blocks or similar items under the vehicle jack; otherwise, it cannot reach its carrying capacity because of the restricted height.
- ▷ If the vehicle is raised, do not lie under the vehicle and do not start the engine; otherwise, a mortal hazard exists. ◀

 Use the vehicle jack only for changing wheels

Use the vehicle jack only for changing wheels. Do not attempt to use it to jack up a different type of vehicle or loads of any kind; otherwise, this could cause material damage and personal injury. ◀

### At a glance

The compact wheel and the tools are located in the cargo area under the cargo floor cover.

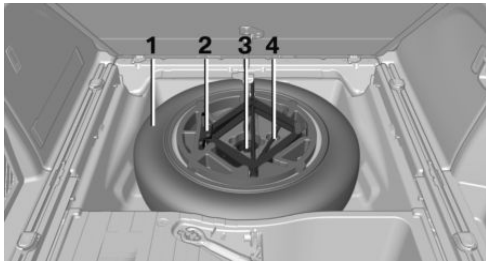

- 1 Compact wheel
- 2 Vehicle jack
- 3 Vehicle jack crank
- 4 Wheel lug wrench

### Remove compact wheel

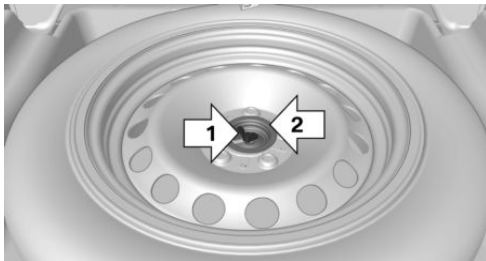

- 1. Remove tool holder.
- 2. Unscrew the wing nut 1.
- 3. Remove the washer 2 to the side.
- 4. Remove compact wheel.

### Prepare wheel change

- 1. Follow the Safety instructions, refer to page 235.
- 2. Loosen the wheel lug bolts a half turn.

### Jacking up the vehicle

- 1. Place the vehicle jack at the jacking point closest to the wheel such that the vehicle jack foot is vertically beneath the vehicle jacking point with the entire surface on the ground.

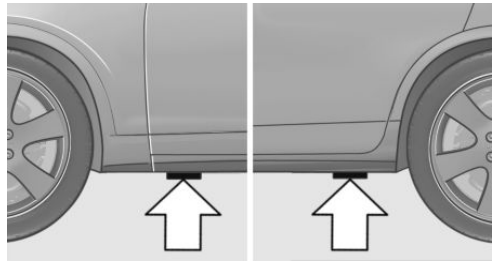

- 2. Insert the vehicle jack head in the rectangular recess of the jacking point for cranking it up.
- 3. Crank it up until the wheel in question lifts off of the ground.

### Wheel mounting

- 1. Unscrew the wheel lug bolts and remove the wheel.
- 2. Put the new wheel or compact wheel on and screw in at least two bolts.  
If original BMW light alloy wheels are not mounted, any accompanying lug bolts also have to be used.
- 3. Screw in the remaining the lug bolts and tighten all bolts well in a crosswise pattern.
- 4. Lower the vehicle and remove the vehicle jack.

### After the wheel change

- 1. Tighten the lug bolts crosswise. The tightening torque is 101 lb ft/140 Nm.



Check for secure seating of the lug bolts

For safety reasons, have the secure seating of the lug bolts checked with a calibrated torque wrench; otherwise, a safety hazard results from incorrectly tightened lug bolts. ◀

2. Stow the defective wheel in the cargo area. The defective wheel cannot be stored under the cargo floor cover because of its size.
3. Check tire inflation pressure at the next opportunity and correct as needed.
4. Reinitialize the Flat Tire Monitor, refer to page 111.  
Reinitialize the Tire Pressure Monitor, refer to page 108.
5. Replace the damaged tires as soon as possible.

### Driving with the compact wheel



Watch the speed when driving with the compact wheel

Drive conservatively and do not exceed a speed of 50 mph/80 km/h; otherwise, changed driving characteristics such as reduced lane stability while braking, extended braking distance and changed self-steering properties in the limit area. ◀



Mounting only one compact wheel

Only a single compact wheel may be mounted. Reinstall wheels and tires of the original size as quickly as possible; otherwise, there is a safety risk. ◀

## Vehicle battery

### Maintenance

The battery is maintenance-free. The added amount of acid is sufficient for the service life of the battery.

Your service center will be glad to advise you on questions regarding the battery.

### Battery replacement



Use approved vehicle batteries only

Only use vehicle batteries that have been approved for your vehicle by the manufacturer; otherwise, the vehicle could be damaged and systems or functions may not be fully available. ◀

After a battery replacement, have the battery registered on the vehicle by your service center to ensure that all comfort functions are fully available and that any Check Control messages of these comfort functions are no longer displayed.

### Charging the battery

#### Note



Do not plug chargers into the socket

Do not connect battery chargers to the factory-installed sockets in the vehicle as this may damage the battery. ◀

### General information

Make sure that the battery is always sufficiently charged to guarantee that the battery remains usable for its full service life.

The battery may need to be charged in the following cases:

- ▷ When making frequent short-distance drives.
- ▷ If the vehicle is not used for prolonged periods, longer than a month.

### Starting aid terminals

In the vehicle, only charge the battery via the starting aid terminals, refer to page 241, in the engine compartment with the engine off.

## Power failure

After a temporary power loss, some equipment needs to be reinitialized.

Individual settings need to be reprogrammed:

- ▷ Time: update.
- ▷ Date: update.
- ▷ Navigation system: wait for the operability of the navigation.

## Disposing of old batteries



Have old batteries disposed of by your service center or bring them to a recycling center.

Maintain the battery in an upright position for transport and storage. Secure the battery so that it does not tip over during transport.

## Fuses

### Hints



Replacing fuses

Never attempt to repair a blown fuse and do not replace a defective fuse with a substitute of another color or amperage rating; this could lead to a circuit overload, ultimately resulting in a fire in the vehicle. ◀

Plastic tweezers and information on the fuse types and locations are stored in the fuse box in the cargo area.

## In the passenger compartment

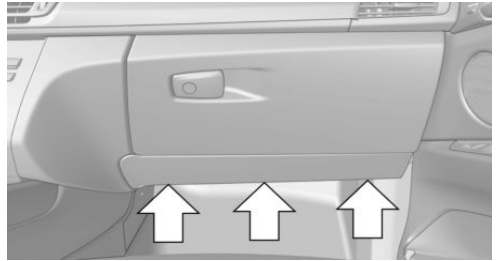

Loosen fasteners, arrows, and open cover.

## In the cargo area

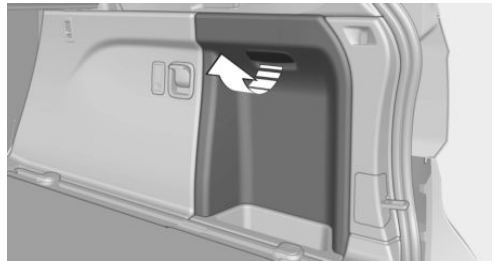

Open the cover on the right side trim.

Information on the fuse types and locations is found on a separate sheet.

# Breakdown assistance

## Vehicle equipment

All standard, country-specific and optional equipment that is offered in the model series is described in this chapter. Therefore, equipment is also described that is not available in a vehicle, e. g., because of the selected optional equipment or country variant. This also applies for safety-related functions and systems.

## Hazard warning flashers

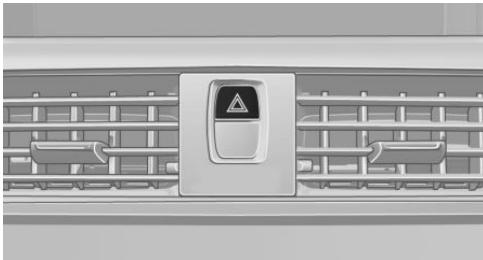

The button is located in the center console.

## Intelligent Emergency Request

### Requirements

- ▷ The radio ready state is switched on.
- ▷ The Assist system is functional.
- ▷ The SIM card integrated in the vehicle has been activated.

### General information

Only press the SOS button in an emergency.

## Hints

- ⚠ Emergency Request not guaranteed  
For technical reasons, the Emergency Request cannot be guaranteed under unfavorable conditions. ◀

## Initiating an Emergency Request



1. Press the cover briefly to open it.
  2. Press the SOS button until the LED in the button lights up.
- ▷ The LED lights up: an Emergency Request was initiated.

If the situation allows, wait in your vehicle until the voice connection has been established.

- ▷ The LED flashes when a connection to the BMW Response Center has been established.

When the emergency request is received at the BMW Response Center, the BMW Response Center contacts you and takes further steps to help you.

Even if you are unable to respond, the BMW Response Center can take further steps to help you under certain circumstances.

For this purpose, data that are used to determine the necessary rescue measures, such as the current position of the vehicle

if it can be established, are transmitted to the BMW Response Center.

- ▷ If the LED is flashing, but the BMW Response Center can no longer be heard via the speaker, you can nevertheless still be heard for the BMW Response Center.

### Initiating an Emergency Request automatically

Under certain conditions, an Emergency Request is automatically initiated immediately after a severe accident. Automatic Collision Notification is not affected by pressing the SOS button.

## Warning triangle

1. Open the cover on the left side trim.

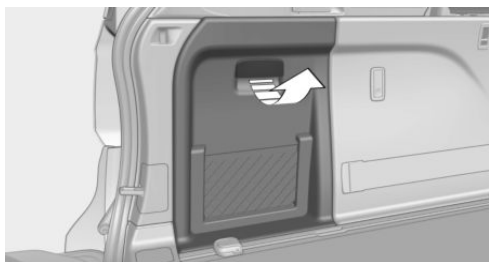

2. To remove, loosen the bracket.

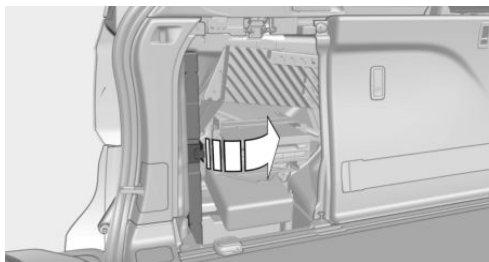

## First aid kit

### Note

Some of the articles have a limited service life.

Check the expiration dates of the contents regularly and replace any expired items promptly.

## Storage

1. Open the cover on the left side trim.

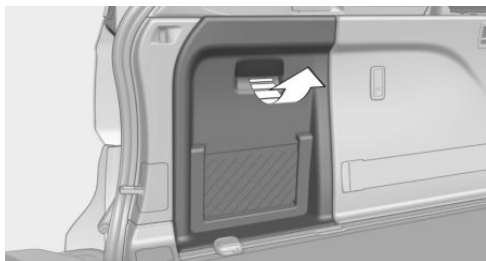

2. Remove the first aid kit.

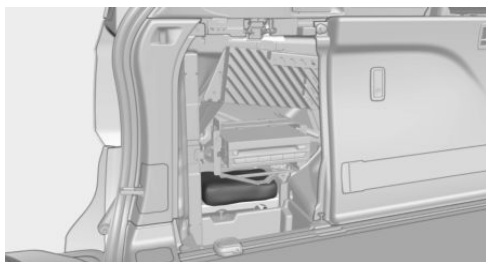

## Roadside Assistance

### Service availability

Roadside Assistance can be reached around the clock in many countries. You can obtain assistance there in the event of a vehicle breakdown.

### Roadside Assistance

The Roadside Assistance phone number can be viewed on the iDrive or a connection to Roadside Assistance can be established directly.

For additional information, see user's manual for Navigation, Entertainment and Communication.



## Jump-starting

### Notes

If the battery is discharged, an engine can be started using the battery of another vehicle and two jumper cables. Only use jumper cables with fully insulated clamp handles.

To prevent personal injury or damage to both vehicles, adhere strictly to the following procedure.

-  Do not touch live parts
- To avoid the risk of potentially fatal injury, always avoid all contact with electrical components while the engine is running. ◀

### Preparation

1. Check whether the battery of the other vehicle has a voltage of 12 volts. This information can be found on the battery.
2. Switch off the engine of the assisting vehicle.
3. Switch off any electronic systems/power consumers in both vehicles.

-  Bodywork contact between vehicles
- Make sure that there is no contact between the bodywork of the two vehicles; otherwise, there is the danger of short circuits. ◀

### Starting aid terminals

-  Connecting order
- Connect the jumper cables in the correct order; otherwise, there is the danger of injury from sparking. ◀

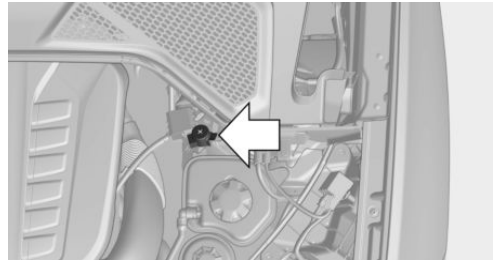

The so-called starting aid terminal in the engine compartment acts as the battery's positive terminal.

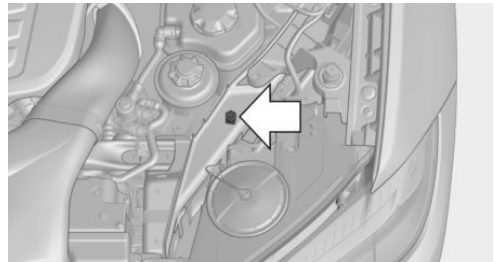

The body ground or a special nut acts as the battery negative terminal.

### Connecting the cables

1. Pull off the cap of the BMW starting aid terminal.
2. Attach one terminal clamp of the positive jumper cable to the positive terminal of the battery, or to the corresponding starting aid terminal of the vehicle providing assistance.
3. Attach the terminal clamp on the other end of the cable to the positive terminal of the battery, or to the corresponding starting aid terminal of the vehicle to be started.
4. Attach one terminal clamp of the negative jumper cable to the negative terminal of the battery, or to the corresponding engine or body ground of assisting vehicle.
5. Attach the second terminal clamp to the negative terminal of the battery, or to the

corresponding engine or body ground of the vehicle to be started.

## Starting the engine

Never use spray fluids to start the engine.

1. Start the engine of the assisting vehicle and let it run for several minutes at an increased idle speed.  
If the vehicle being started has a diesel engine: let the engine of the assisting vehicle run for approx. 10 minutes.
2. Start the engine of the vehicle being started in the usual way.  
If the first starting attempt is not successful, wait a few minutes before making another attempt in order to allow the discharged battery to recharge.
3. Let both engines run for several minutes.
4. Disconnect the jumper cables in the reverse order.

Check the battery and recharge if necessary.

## Tow-starting and towing

### Note

 Tow-starting and towing  
When tow-starting and towing the vehicle, switch off the Intelligent Safety systems; otherwise, improper behavior of the braking function of individual systems could result in an accident. ◀

Switch off Intelligent Safety systems, refer to page 112.

## Transporting your vehicle

### Note

Your vehicle is not permitted to be towed. Therefore, contact a service center in the event of a breakdown.

 Do not have the vehicle towed  
Have your vehicle transported on a loading platform only; otherwise, damage may occur. ◀

## Tow truck

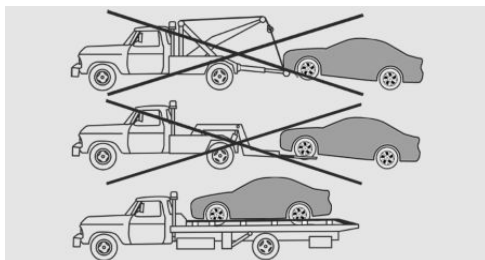

 Do not lift the vehicle  
Do not lift the vehicle by the tow fitting or body and chassis parts; otherwise, damage may result. ◀

## Towing other vehicles

### General information

 Light towing vehicle  
The towing vehicle must not be lighter than the vehicle being towed; otherwise, it will not be possible to control the vehicle response. ◀

 Attaching the tow bar/tow rope correctly  
Attach the tow bar or tow rope to the tow fitting; connecting it to other vehicle parts may cause damage. ◀

- ▷ Switch on the hazard warning system, depending on local regulations.
- ▷ If the electrical system has failed, clearly identify the vehicle being towed by placing a sign or a warning triangle in the rear window.

## Towing methods when towing other vehicles

### Tow bar

The tow fittings used should be on the same side on both vehicles.

Should it prove impossible to avoid mounting the tow bar at an offset angle, please observe the following:

- ▷ Maneuvering capability is limited during cornering.
- ▷ The tow bar will generate lateral forces if it is secured with an offset.

### Tow rope

When starting to tow the vehicle, make sure that the tow rope is taut.

To avoid jerking and the associated stresses on the vehicle components when towing, always use nylon ropes or nylon straps.

-  Attaching the tow rope correctly  
Only secure the tow rope on the tow fitting; otherwise, damage can occur when it is secured on other parts of the vehicle. ◀

### Tow fitting

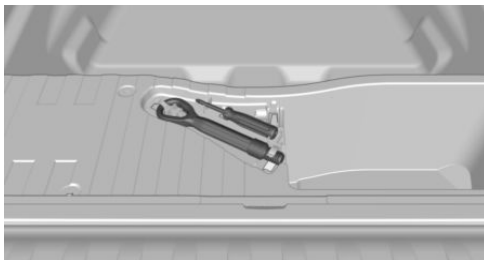

The screw-in tow fitting should always be carried in the vehicle. It can be screwed in at the front or rear of the BMW. It is located in the on-board vehicle tool kit under the cargo area floor.

-  Tow fitting, information on use

- ▷ Use only the tow fitting provided with the vehicle and screw it all the way in.
- ▷ Use the tow fitting for towing on paved roads only.
- ▷ Use the tow fitting screwed in at the front for maneuvering the vehicle only.
- ▷ Avoid lateral loading of the tow fitting, e.g., do not lift the vehicle by the tow fitting.

Otherwise, damage to the tow fitting and the vehicle can occur. ◀

### Screw thread

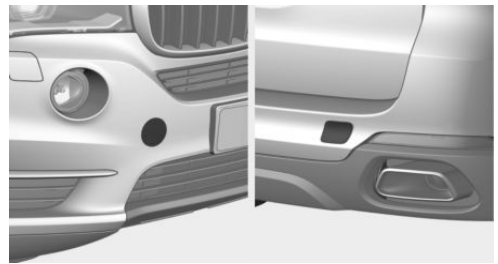

Press on the mark of the cover to push it out.

### Tow-starting

#### Automatic transmission

Do not tow-start the vehicle.

Due to the automatic transmission, the engine cannot be started by tow-starting.

Have the cause of the starting difficulties remedied.

# Care

## Vehicle equipment

All standard, country-specific and optional equipment that is offered in the model series is described in this chapter. Therefore, equipment is also described that is not available in a vehicle, e. g., because of the selected optional equipment or country variant. This also applies for safety-related functions and systems.

## Car washes

### Hints

 Steam jets or high-pressure washers  
When using steam jets or high-pressure washers, hold them a sufficient distance away and use a maximum temperature of 140 °F/60 °C.

If the vehicle has a glass sunroof, ensure that a distance of at least 31.5 inches/80 cm is maintained. Holding them too close or using excessively high pressures or temperatures can cause damage or preliminary damage that may then lead to long-term damage.

Follow the user's manual for the high-pressure washer. ◀

 Cleaning sensors/cameras with high-pressure washers

When using high-pressure washers, do not spray the exterior sensors and cameras, e.g., Park Distance Control, for extended periods of time and only from a distance of at least 12 in/30 cm. ◀

- ▷ Regularly remove foreign items such as leaves in the area below the windshield when the hood is raised.
- ▷ Wash your vehicle frequently, particularly in winter.

Intense soiling and road salt can damage the vehicle.

## Automatic car washes

### Hints

Note the following:

- ▷ Give preference to cloth car washes or those that use soft brushes in order to avoid paint damage.
- ▷ Make sure that the wheels and tires are not damaged by the transport mechanisms.
- ▷ Fold in the exterior mirrors; otherwise, they may be damaged, depending on the width of the vehicle.
- ▷ Deactivate, refer to page 76, the rain sensor to avoid unintentional wiper activation.
- ▷ In some cases, an unintentional alarm can be triggered by the interior motion sensor of the alarm system. Follow the instructions on avoiding an unintentional alarm, refer to page 46.

 Guide rails in car washes  
Avoid car washes with guide rails higher than 4 in/10 cm; otherwise, the vehicle body could be damaged. ◀

## Different types of tires

 Observing vehicle width  
Before entering washing systems, make sure that the vehicle width is not too great for the car wash; otherwise, there could be damage to the vehicle and car wash. ◀

## Before driving into a car wash

In order to ensure that the vehicle can roll in a car wash, take the following steps:

1. Drive into the car wash.

2. Engage transmission position N.
3. Switch the engine off.

In this way, the ignition remains switched on, and a Check-Control message is displayed.



Do not turn off the ignition in the car wash

Do not turn off the ignition in the car wash; otherwise, the transmission position P is engaged and damages can result. ◀

To start the engine:

1. Depress the brake pedal.
2. Press the Start/Stop button.

Pressing the Start/Stop button without stepping on the brake turns the ignition off.

The vehicle cannot be locked from the outside when in transmission position N. A signal is sounded when an attempt is made to lock the vehicle.

## Transmission position

Transmission position P is engaged automatically:

- ▶ When the ignition is switched off.
- ▶ After approx. 15 minutes.

## Headlamps

- ▶ Do not rub dry and do not use abrasive or caustic cleansers.
- ▶ Soak areas that have been soiled e.g. due to insects, with shampoo and wash off with water.
- ▶ Thaw ice with deicing spray; do not use an ice scraper.

## After washing the vehicle

After washing the vehicle, apply the brakes briefly to dry them; otherwise, braking action can be reduced and corrosion of the brake discs can occur.

Completely remove all residues on the windows, to minimize loss of visibility due to smearing and to reduce wiper noises and wiper blade wear.

## Vehicle care

### Car care products

BMW recommends using cleaning and care products from BMW, since these have been tested and approved.



Car care and cleaning products

Follow the instructions on the container.

When cleaning the interior, open the doors or windows.

Only use products intended for cleaning vehicles.

Cleansers can contain substances that are dangerous and harmful to your health. ◀

### Vehicle paint

Regular care contributes to driving safety and value retention. Environmental influences in areas with elevated air pollution or natural contaminants, such as tree resin or pollen can affect the vehicle's paintwork. Tailor the frequency and extent of your car care to these influences.

Aggressive substances, such as spilled fuel, oil, grease or bird droppings, must be removed immediately to prevent the finish from being altered or discolored.

### Leather care

Remove dust from the leather often, using a cloth or vacuum cleaner.

Otherwise, particles of dust and road grime chafe in pores and folds, and lead to increased wear and premature degradation of the leather surface.

To guard against discoloration, such as from clothing, provide leather care roughly every two months.

Clean light-colored leather more frequently because soiling on such surfaces is substantially more visible.

Use leather care products; otherwise, dirt and grease will gradually break down the protective layer of the leather surface.

Suitable care products are available from the service center.

### Upholstery material care

Vacuum regularly with a vacuum cleaner.

If they are very dirty, e.g., beverage stains, use a soft sponge or microfiber cloth with a suitable interior cleaner.

Clean the upholstery down to the seams using large sweeping motions. Avoid rubbing the material vigorously.

 Damage from Velcro® fasteners  
Open Velcro® fasteners on pants or other articles of clothing can damage the seat covers. Ensure that any Velcro® fasteners are closed. ◀

### Caring for special components

#### Light-alloy wheels

When cleaning the vehicle, use only neutral wheel cleaners having a pH value from 5 to 9. Do not use abrasive cleaning agents or steam jets above 140 °F/60 °C. Follow the manufacturer's instructions.

Aggressive, acidic or alkaline cleaning agents can destroy the protective layer of adjacent components, such as the brake disk.

#### Chrome surfaces

Carefully clean components such as the radiator grille or door handles with an ample supply of water, possibly with shampoo added, partic-

ularly when they have been exposed to road salt.

### Rubber components

Aside from water, treat only with rubber cleansers.

When cleaning rubber seals, do not use any silicon-containing car care products in order to avoid damage or reduced noise damping.

### Fine wood parts

Clean fine wood facing and fine wood components only with a moist rag. Then dry with a soft cloth.

### Plastic components

These include:

- ▷ Imitation leather surfaces.
- ▷ Headliner.
- ▷ Lamp lenses.
- ▷ Instrument cluster cover.
- ▷ Matte black spray-coated components.
- ▷ Painted parts in the interior.

Clean with a microfiber cloth.

Lightly dampen the cloth with water.

Do not soak the headliner.

 Do not use cleansers that contain alcohol or solvents

Do not use cleansers that contain alcohol or solvents, such as lacquer thinners, heavy-duty grease removers, fuel, or such; this could lead to surface damage. ◀

### Safety belts

Dirty belt straps impede the reeling action and thus have a negative impact on safety.

 Chemical cleaning  
Do not clean chemically; this can destroy the webbing. ◀

Use only a mild soapy solution, with the safety belts clipped into their buckles.

Do not allow the reels to retract the safety belts until they are dry.

### Carpets and floor mats



No objects in the area around the pedals

Keep floor mats, carpets, and any other objects out of the area of motion of the pedals; otherwise, the function of the pedals could be impeded while driving and create the risk of an accident.

Do not place additional floor mats over existing mats or other objects.

Only use floor mats that have been approved for the vehicle and can be properly fixed in place.

Ensure that the floor mats are securely fastened again after they were removed for cleaning, for example. ◀

Floor mats can be removed from the passenger compartment for cleaning.

If the floor carpets are very dirty, clean with a microfiber cloth and water or a textile cleaner. To prevent matting of the carpet, rub back and forth in the direction of travel only.

### Sensors/cameras

To clean sensors and cameras, use a cloth moistened with a small amount of glass cleaner.

### Displays/screens

Clean the displays with an antistatic microfiber cloth.



Cleaning displays

Do not use chemical or household cleansers.

Keep all fluids and moisture away from the unit.

Otherwise, they could affect or damage surfaces or electrical components.

Avoid pressing too hard when cleaning and do not use abrasive materials; otherwise, damage can result. ◀

### Long-term vehicle storage

When the vehicle is shut down for longer than three months, special measures must be taken. Additional information is available from the service center.





## Reference

This chapter contains the technical data and an index that will quickly take you to the information you need.

# Technical data

## Vehicle equipment

All standard, country-specific and optional equipment that is offered in the model series is described in this chapter. Therefore, equip-

ment is also described that is not available in a vehicle, e. g., because of the selected optional equipment or country variant. This also applies for safety-related functions and systems.

## Dimensions

### BMW X5

Width with mirrors	inches/mm	86.0/2,184
Width without mirrors	inches/mm	76.3/1,938
Width without mirrors with 20" wheels	inches/mm	78.2/1,985
Height	inches/mm	69.4/1,762
Length	inches/mm	193.2/4,908
Wheel base	inches/mm	115.5/2,933
Smallest turning circle diam.	ft/m	41.8/12.7

## Weights

### X5 sDrive35i

Approved gross vehicle weight	lbs/kg	6,070/2,753
With the third row of seats	lbs/kg	6,350/2,880
Load	lbs/kg	1,110/503
With the third row of seats	lbs/kg	1,350/612
Approved front axle load	lbs/kg	2,670/1,211
With the third row of seats	lbs/kg	2,680/1,216
Approved rear axle load	lbs/kg	3,540/1,606
With the third row of seats	lbs/kg	3,840/1,742
Approved roof load capacity	lbs/kg	220/100
Cargo area capacity	cu ft/l	22.94–66.03/650–1,870

## X5 xDrive35i

Approved gross vehicle weight	lbs/kg	6,250/2,835
With the third row of seats	lbs/kg	6,460/2,930
Load	lbs/kg	1,110/503
With the third row of seats	lbs/kg	1,350/612
Approved front axle load	lbs/kg	2,820/1,279
With the third row of seats	lbs/kg	2,780/1,261
Approved rear axle load	lbs/kg	3,580/1,624
With the third row of seats	lbs/kg	3,840/1,742
Approved roof load capacity	lbs/kg	220/100
Cargo area capacity	cu ft/l	22.94–66.03/650–1,870

## X5 xDrive50i

Approved gross vehicle weight	lbs/kg	6,550/2,971
With the third row of seats	lbs/kg	6,690/3,035
Load	lbs/kg	1,110/503
With the third row of seats	lbs/kg	1,240/562
Approved front axle load	lbs/kg	2,990/1,356
With the third row of seats	lbs/kg	2,970/1,347
Approved rear axle load	lbs/kg	3,700/1,678
With the third row of seats	lbs/kg	3,850/1,746
Approved roof load capacity	lbs/kg	220/100
Cargo area capacity	cu ft/l	22.94–66.03/650–1,870

## X5 xDrive35d

Approved gross vehicle weight	lbs/kg	6,400/2,903
With the third row of seats	lbs/kg	6,600/2,994
Load	lbs/kg	1,110/503
With the third row of seats	lbs/kg	1,350/612
Approved front axle load	lbs/kg	2,940/1,334
With the third row of seats	lbs/kg	2,910/1,320

## X5 xDrive35d

Approved rear axle load	lbs/kg	3,600/1,633
With the third row of seats	lbs/kg	3,850/1,746
Approved roof load capacity	lbs/kg	220/100
Cargo area capacity	cu ft/l	22.94–66.03/650–1,870

## Capacities

	US gal/liters	Notes
Fuel tank	22.4/85	Fuel quality, refer to page <a href="#">206</a>



# Everything from A to Z

## Index

### A

- ABS, Antilock Brake System **131**
- ACC, Active Cruise Control with Stop & Go **138**
- Acceleration Assistant, refer to Launch Control **80**
- Activated-charcoal filter **168**
- Active Blind Spot Detection **126**
- Active Cruise Control with Stop & Go, ACC **138**
- Active Protection **128**
- Active roll stabilization **135**
- Active seat ventilation, front **53**
- Active Steering **134**
- Adaptive brake lights, refer to Brake force display **128**
- Adaptive Light Control **100**
- Additives, oil **225**
- Adjustments, seats/head restraints **50**
- After washing vehicle **245**
- Airbags **104**
- Airbags, indicator/warning light **105**
- Air circulation, refer to Recirculated-air mode **167**
- Air, dehumidifying, refer to Cooling function **167**
- Air distribution, manual **166**
- Air flow, automatic climate control **166**
- Air pressure, tires **211**
- Air vents, refer to Ventilation **168**
- Alarm system **45**
- Alarm, unintentional **46**
- All around the center console **16**
- All around the headliner **17**
- All around the steering wheel **14**
- All-season tires, refer to Winter tires **219**
- All-wheel-drive **133**
- Alternating-code hand-held transmitter **176**
- Alternative oil types **226**
- Antifreeze, washer fluid **77**
- Antilock Brake System, ABS **131**
- Anti-slip control, refer to DSC **132**
- Approved axle load **250**
- Approved engine oils **225**
- Arrival time **94**
- Ashtray **177**
- Ashtray, front **177**
- Assistance, Roadside Assistance **240**
- Assistance when driving off **131**
- Assist system, refer to Intelligent Safety **112**
- Attentiveness assistant **128**
- AUTO H button, refer to Automatic Hold **72**
- AUTO intensity **166**
- Automatic car wash **244**
- Automatic climate control **165**
- Automatic Cruise Control with Stop & Go **138**
- Automatic Curb Monitor **60**
- Automatic deactivation, front passenger airbags **106**
- Automatic headlamp control **100**
- Automatic Hold **72**
- Automatic locking **44**
- Automatic recirculated-air control **167**
- Automatic Soft Closing, doors **40**
- Automatic tailgate **40**
- Automatic transmission with Steptronic **78**
- AUTO program, automatic climate control **166**
- AUTO program, intensity **166**
- Auto Start/Stop function **69**
- Average fuel consumption **94**
- Average speed **94**
- Axle loads, weights **250**

### B

- Backrest curvature, refer to Lumbar support **52**
- Backrest, width **53**
- Backup camera **153**
- Bad road trips **193**
- Band-aids, refer to First aid kit **240**
- Bar for tow-starting/towing **243**
- Battery replacement, vehicle battery **237**
- Battery replacement, vehicle remote control **34**
- Battery, vehicle **237**
- Belts, safety belts **55**
- Beverage holder, cupholder **185**
- Blinds, sun protection **48**
- BMW Advanced Diesel **207**
- BMW Assist, see user's manual for Navigation, En-

- ertainment and Communication  
BMW Homepage [6](#)  
BMW Internet page [6](#)  
BMW maintenance system [229](#)  
Bonus range, ECO PRO [199](#)  
Bottle holder, refer to Cupholder [185](#)  
Brake assistant [131](#)  
Brake discs, breaking in [190](#)  
Brake force display [128](#)  
Brake lamps, brake force display [128](#)  
Brake lights, adaptive [128](#)  
Brake pads, breaking in [190](#)  
Braking, hints [192](#)  
Breakdown assistance [239](#), [240](#)  
Breaking in [190](#)  
Brightness of Control Display [96](#)  
Bulb replacement [232](#)  
Bulb replacement, front [233](#)  
Bulb replacement, rear [235](#)  
Bulbs and lamps [232](#)  
Button, RES [141](#)  
Button, Start/Stop [67](#)  
Bypassing, refer to Jump-starting [241](#)
- C**
- California Proposition 65 Warning [7](#)  
Calling up mirror adjustment [45](#)  
Calling up seat adjustment [45](#)  
Calling up steering wheel adjustment [45](#)  
Camera, care [247](#)  
Camera, Panorama View [158](#)  
Camera, rearview camera [153](#)  
Camera, Top View [156](#)  
Can holder, refer to Cupholder [185](#)  
Car battery [237](#)  
Car care products [245](#)  
Care, displays [247](#)  
Care, vehicle [245](#)  
Cargo [194](#)  
Cargo area [180](#)  
Cargo area, enlarging [180](#)  
Cargo area lid [40](#)  
Cargo area, storage compartments [186](#)  
Cargo cover [180](#)  
Cargo, securing [195](#)  
Cargo straps, securing cargo [195](#)  
Car key, refer to Remote control [34](#)  
Carpet, care [247](#)  
Car wash [244](#)  
Catalytic converter, refer to Hot exhaust system [190](#)  
CBS Condition Based Service [229](#)  
CD/Multimedia, see user's manual for Navigation, Entertainment and Communication  
Center armrest [183](#)  
Center console [16](#)  
Center-Lock, see button for central locking [37](#)  
Central locking system [37](#)  
Central screen, refer to Control Display [18](#)  
Changes, technical, refer to Safety [7](#)  
Changing parts [231](#)  
Changing wheels [235](#)  
Changing wheels/tires [218](#)  
Check Control [86](#)  
Checking the oil level electronically [224](#)  
Children, seating position [63](#)  
Children, transporting safely [63](#)  
Child restraint fixing system [63](#)  
Child restraint fixing system LATCH [65](#)  
Child restraint fixing systems, mounting [63](#)  
Child safety locks [66](#)  
Child seat, mounting [63](#)  
Child seats [63](#)  
Chrome parts, care [246](#)  
Cigarette lighter [177](#)  
Cleaning, displays [247](#)  
Climate control [165](#)  
Climate control windshield [191](#)  
Clock [89](#)  
Closing/opening from inside [40](#)  
Closing/opening via door lock [39](#)  
Closing/opening with remote control [38](#)  
Clothes hooks [186](#)  
Coasting [200](#)  
Coasting with engine decoupled, coasting [200](#)  
Coasting with idling engine [200](#)  
Cockpit [14](#)  
Cold starting, refer to Starting the engine [68](#)  
Collision warning with braking function [116](#)  
Collision warning with City Braking function [113](#)  
Combination switch, refer to Turn signals [74](#)  
Combination switch, refer to Wiper system [75](#)  
Comfort Access [43](#)  
COMFORT program, Driving Dynamics Control [137](#)  
Compact wheel [235](#)  
Compartments in the doors [183](#)  
Compass [94](#)

- Computer [93](#)
- Condensation on windows [166](#)
- Condensation under the vehicle [192](#)
- Condition Based Service CBS [229](#)
- Confirmation signal [44](#)
- Congestion Assistant [145](#)
- ConnectedDrive, see user's manual for Navigation, Entertainment and Communication
- ConnectedDrive Services
- Connecting electrical devices [178](#)
- Connection for an external audio device [184](#)
- Control Display [18](#)
- Control Display, settings [95](#)
- Controller [18](#), [19](#)
- Control systems, driving stability [131](#)
- Convenient opening [38](#)
- Coolant [227](#)
- Coolant temperature [89](#)
- Cooling function [167](#)
- Cooling, maximum [167](#)
- Cooling system [227](#)
- Corrosion on brake discs [192](#)
- Cruise control [148](#)
- Cruise control, active with Stop & Go [138](#)
- Cruise Control, refer to Active Cruise Control [138](#)
- Cruising range [89](#)
- Cupholder [185](#)
- Current fuel consumption [90](#)
- D**
- Damage, tires [218](#)
- Data, technical [250](#)
- Date [89](#)
- Daytime running lights [100](#)
- Defrosting, refer to Windows, defrosting [166](#)
- Dehumidifying, air [167](#)
- Departure time, parked-car heating [172](#)
- Departure time, parked-car ventilation [172](#)
- Destination distance [94](#)
- Diesel exhaust fluid, at low temperatures [208](#)
- Diesel exhaust fluid, having refilled [208](#)
- Diesel exhaust fluid, on minimum [208](#)
- Diesel exhaust fluid, replenishing yourself [208](#)
- Diesel particulate filter [191](#)
- Digital clock [89](#)
- Dimensions [250](#)
- Dimmable exterior mirrors [61](#)
- Dimmable interior rearview mirror [61](#)
- Direction indicator, refer to Turn signals [74](#)
- Display, electronic, instrument cluster [84](#)
- Display in windshield [97](#)
- Display lighting, refer to Instrument lighting [102](#)
- Displays [82](#)
- Displays, cleaning [247](#)
- Disposal, coolant [228](#)
- Disposal, vehicle battery [238](#)
- Distance control, refer to PDC [150](#)
- Distance information [164](#)
- Distance to destination [94](#)
- Divided screen view, split screen [24](#)
- Door lock, refer to Remote control [34](#)
- Doors, Automatic Soft Closing [40](#)
- Downhill control [133](#)
- Drink holder, third row of seats [186](#)
- Drive-off assistant [131](#)
- Drive-off assistant, refer to DSC [132](#)
- Driving Dynamics Control [135](#)
- Driving instructions, breaking in [190](#)
- Driving mode [135](#)
- Driving notes, general [190](#)
- Driving on bad roads [193](#)
- Driving stability control systems [131](#)
- Driving tips [190](#)
- DSC Dynamic Stability Control [132](#)
- DTC driving dynamics [133](#)
- DTC Dynamic Traction Control [133](#)
- Dynamic Stability Control DSC [132](#)
- Dynamic Traction Control DTC [133](#)
- E**
- ECO PRO [198](#)
- ECO PRO, bonus range [199](#)
- ECO PRO display [198](#)
- ECO PRO driving mode [198](#)
- ECO PRO mode [198](#)
- ECO PRO Tip - driving instruction [199](#)
- EfficientDynamics [200](#)
- Electronic displays, instrument cluster [84](#)
- Electronic Stability Program ESP, refer to DSC [132](#)
- Emergency detection, remote control [35](#)
- Emergency release, door lock [40](#)
- Emergency release, fuel filler flap [204](#)
- Emergency release, parking brake [73](#)
- Emergency Request [239](#)



- Emergency service, refer to Roadside Assistance [240](#)
- Emergency start function, engine start [35](#)
- Energy Control [90](#)
- Energy recovery [90](#)
- Engine, automatic Start/Stop function [69](#)
- Engine, automatic switch-off [69](#)
- Engine compartment [222](#)
- Engine compartment, working in [222](#)
- Engine coolant [227](#)
- Engine idling when driving, coasting [200](#)
- Engine oil [224](#)
- Engine oil, adding [225](#)
- Engine oil additives [225](#)
- Engine oil change [226](#)
- Engine oil filler neck [225](#)
- Engine oil temperature [88](#)
- Engine oil types, alternative [226](#)
- Engine oil types, approved [225](#)
- Engine start during malfunction [35](#)
- Engine start, jump-starting [241](#)
- Engine start, refer to Starting the engine [68](#)
- Engine stop [68](#)
- Engine temperature [88](#)
- Entering a car wash [244](#)
- Equipment, interior [175](#)
- ESP Electronic Stability Program, refer to DSC [132](#)
- Exchanging wheels/tires [218](#)
- Exhaust system [190](#)
- Exterior mirror, automatic dimming feature [61](#)
- Exterior mirrors [60](#)
- External start [241](#)
- External temperature display [89](#)
- External temperature warning [89](#)
- Eyes for securing cargo [195](#)
- ## F
- Failure message, refer to Check Control [86](#)
- False alarm, refer to Unintentional alarm [46](#)
- Fan, refer to Air flow [166](#)
- Fault displays, refer to Check Control [86](#)
- Filler neck for engine oil [225](#)
- Fine wood, care [246](#)
- First aid kit [240](#)
- Fitting for towing, refer to Tow fitting [243](#)
- Flat tire, changing wheels [235](#)
- Flat Tire Monitor FTM [110](#)
- Flat Tire, Tire Pressure Monitor TPM [107](#)
- Flat tire, warning lamp [108](#), [111](#)
- Flooding [191](#)
- Floor carpet, care [247](#)
- Floor mats, care [247](#)
- Fold-out position, windshield wipers [77](#)
- Foot brake [192](#)
- Front airbags [104](#)
- Front center armrest [183](#)
- Front cupholder [185](#)
- Front fog lamps [102](#)
- Front fog lamps/cornering lamps, bulb replacement [233](#)
- Front fog lamps, bulb replacement [234](#)
- Front lamps [233](#)
- Front passenger airbags, automatic deactivation [106](#)
- Front passenger airbags, indicator lamp [106](#)
- FTM Flat Tire Monitor [110](#)
- Fuel [206](#)
- Fuel cap [204](#)
- Fuel consumption, current [90](#)
- Fuel consumption, refer to Average fuel consumption [94](#)
- Fuel filler flap [204](#)
- Fuel gauge [88](#)
- Fuel quality [206](#)
- Fuel recommendation [206](#)
- Fuel, tank capacity [252](#)
- Fuse [238](#)
- ## G
- Garage door opener, refer to Universal garage door opener [175](#)
- Gasoline [206](#)
- Gasoline quality [206](#)
- Gear change, automatic transmission [78](#)
- Gear shift indicator [91](#)
- General driving notes [190](#)
- Glare shield [181](#)
- Glasses compartment [184](#)
- Glass sunroof, refer to Panoramic glass sunroof [48](#)
- Glove compartment [182](#)
- Gross vehicle weight, approved [250](#)
- ## H
- Handbrake, refer to Parking brake [71](#)
- Hand-held transmitter, alternating code [176](#)
- Hazard warning flashers [239](#)
- HDC Hill Descent Control [133](#)
- Head airbags [104](#)
- Headlamp control, automatic [100](#)
- Headlamp courtesy delay feature [99](#)

Headlamp flasher [75](#)  
Headlamp glass [233](#)  
Headlamps [233](#)  
Headlamps, care [245](#)  
Headlamp washer system [75](#)  
Headliner [17](#)  
Head restraints [50](#)  
Head restraints, front [57](#)  
Head restraints, rear [58](#)  
Head-up Display [97](#)  
Head-up Display, care [247](#)  
Heating, refer to Parked-car heating [171](#)  
Heavy cargo, stowing [195](#)  
High-beam Assistant [101](#)  
High beams [75](#)  
High beams/low beams, refer to High-beam Assistant [101](#)  
Hill Descent Control  
HDC [133](#)  
Hills [192](#)  
Hill start assistant, refer to Drive-off assistant [131](#)  
Hints [6](#)  
Holder for beverages [185](#)  
Homepage [6](#)  
Hood [222](#)  
Horn [14](#)  
Hot exhaust system [190](#)  
HUD Head-up Display [97](#)  
Hydroplaning [191](#)

**I**

Ice warning, refer to External temperature warning [89](#)  
Icy roads, refer to External temperature warning [89](#)  
Identification marks, tires [216](#)  
Identification number, refer to Important features in the engine compartment [222](#)  
iDrive [18](#)  
Ignition key, refer to Remote control [34](#)  
Ignition off [67](#)

Ignition on [67](#)  
Indication of a flat tire [108](#), [111](#)  
Indicator and warning lamps [86](#)  
Individual air distribution [166](#)  
Individual settings, refer to Personal Profile [35](#)  
Inflation pressure, tires [211](#)  
Inflation pressure warning FTM, tires [110](#)  
Info display, refer to Computer [93](#)  
Initialize, Tire Pressure Monitor TPM [108](#)  
Initializing, Flat Tire Monitor FTM [111](#)  
Instrument cluster [82](#)  
Instrument cluster, electronic displays [84](#)  
Instrument lighting [102](#)  
Integrated key [34](#)  
Intelligent Emergency Request [239](#)  
Intelligent Safety [112](#)  
Intensity, AUTO program [166](#)  
Interior equipment [175](#)  
Interior lamps [102](#)  
Interior lamps via remote control [38](#)  
Interior motion sensor [46](#)  
Interior rearview mirror, automatic dimming feature [61](#)  
Internet page [6](#)  
Interval display, service requirements [90](#)

**J**

Jacking points for the vehicle jack [235](#)  
Joystick, automatic transmission [78](#)  
Jump-starting [241](#)

**K**

Key/remote control [34](#)  
Keyless Go, refer to Comfort Access [43](#)  
Key Memory, refer to Personal Profile [35](#)  
Kickdown, automatic transmission [78](#)  
Knee airbag [104](#)

**L**

Lamp replacement [232](#)  
Lamp replacement, front [233](#)  
Lamp replacement, rear [235](#)  
Lamps [99](#)  
Lamps and bulbs [232](#)  
Lane departure warning [125](#)  
Lane margin, warning [125](#)  
Language on Control Display [96](#)  
Lashing eyes, securing cargo [195](#)  
LATCH child restraint fixing system [65](#)  
Launch Control [80](#)  
Leather, care [245](#)  
LED front fog lamps, bulb replacement [234](#)  
LEDs, light-emitting diodes [232](#)  
Letters and numbers, entering [25](#)  
Light alloy wheels, care [246](#)  
Light control [100](#)  
Light-emitting diodes, LEDs [232](#)  
Lighting [99](#)  
Lighting via remote control [38](#)  
Light switch [99](#)  
Load [195](#)  
Loading [194](#)  
Lock, door [39](#)

Locking/unlocking from inside [40](#)  
Locking/unlocking via door lock [39](#)  
Locking/unlocking with remote control [38](#)  
Locking, automatic [44](#)  
Locking, central [37](#)  
Locking, settings [44](#)  
Lock, power window [47](#)  
Locks, doors, and windows [66](#)  
Low beams [99](#)  
Low beams, automatic, refer to High-beam Assistant [101](#)  
Lower back support [52](#)  
Lower tailgate [43](#)  
Low-Sulfur Diesel [207](#)  
Luggage rack, refer to Roof-mounted luggage rack [196](#)  
Lumbar support [52](#)

## M

Maintenance [229](#)  
Maintenance requirements [229](#)  
Maintenance, service requirements [90](#)  
Maintenance system, BMW [229](#)  
Malfunction displays, refer to Check Control [86](#)  
Malfunction, self-leveling suspension [135](#)  
Manual air distribution [166](#)  
Manual air flow [166](#)  
Manual brake, refer to Parking brake [71](#)  
Manual mode, transmission [79](#)  
Manual operation, backup camera [154](#)  
Manual operation, door lock [40](#)  
Manual operation, exterior mirrors [60](#)  
Manual operation, fuel filler flap [204](#)  
Manual operation, Park Distance Control PDC [151](#)  
Manual operation, parking brake [73](#)  
Manual operation, Top View [157](#)  
Marking on approved tires [219](#)  
Marking, run-flat tires [220](#)  
Master key, refer to Remote control [34](#)  
Maximum cooling [167](#)  
Maximum speed, display [91](#)  
Maximum speed, winter tires [220](#)  
Measure, units of [96](#)  
Medical kit [240](#)  
Memory for seat, mirrors, steering wheel [59](#)  
Menu, EfficientDynamics [200](#)  
Menu in instrument cluster [93](#)  
Menus, operating, iDrive [18](#)  
Menus, refer to iDrive operating concept [20](#)  
Messages, refer to Check Control [86](#)  
Microfilter [168](#)  
Minimum tread, tires [218](#)  
Mirror [60](#)  
Mirror memory [59](#)  
Mobile communication devices in the vehicle [191](#)  
Modifications, technical, refer to Safety [7](#)  
Moisture in headlamp [233](#)  
Monitor, refer to Control Display [18](#)  
Mounting of child restraint fixing systems [63](#)  
Moving sun shade [181](#)

Multifunction steering wheel, buttons [14](#)

## N

Navigation, see user's manual for Navigation, Entertainment and Communication  
Neck restraints, front, refer to Head restraints [57](#)  
Neck restraints, rear, refer to Head restraints [58](#)  
Neutral cleaner, see wheel cleaner [246](#)  
New wheels and tires [218](#)  
Night Vision with pedestrian detection [121](#)  
No Passing Information [91](#)  
Nylon rope for tow-starting/towing [243](#)

## O

OBD Onboard Diagnosis [229](#)  
OBD, see OBD Onboard Diagnosis [229](#)  
Obstacle marking, rearview camera [155](#)  
Octane rating, refer to Gasoline quality [206](#)  
Odometer [89](#)  
Office, see user's manual for Navigation, Entertainment and Communication  
Offroad trips [193](#)  
Oil [224](#)  
Oil, adding [225](#)  
Oil additives [225](#)  
Oil change [226](#)  
Oil change interval, service requirements [90](#)  
Oil filler neck [225](#)  
Oil types, alternative [226](#)  
Oil types, approved [225](#)  
Old batteries, disposal [238](#)

- Onboard monitor, refer to  
Control Display [18](#)
- Onboard vehicle tool kit [231](#)
- Opening and closing [34](#)
- Opening and closing, from inside [40](#)
- Opening and closing via door lock [39](#)
- Opening and closing, with remote control [38](#)
- Operating concept, iDrive [18](#)
- Optional equipment, standard equipment [6](#)
- Outside air, refer to Automatic recirculated-air control [167](#)
- Overheating of engine, refer to Coolant temperature [89](#)
- ## P
- Paint, vehicle [245](#)
- Panorama Side View [158](#)
- Panoramic glass sunroof [48](#)
- Parallel parking assistant [159](#)
- Park Distance Control  
PDC [150](#)
- Parked-car heating [171](#)
- Parked-car ventilation [171](#)
- Parked vehicle, condensation [192](#)
- Parking aid, refer to PDC [150](#)
- Parking assistant [159](#)
- Parking brake [71](#)
- Parking lamps [99](#)
- Parking with Auto Hold [72](#)
- Particulate filter [191](#)
- Passenger side mirror, tilting downward [60](#)
- Pathway lines, rearview camera [154](#)
- PDC Park Distance Control [150](#)
- Pedestrian detection, refer to Night Vision [121](#)
- Pedestrian warning with city braking function [119](#)
- People detection, refer to Night Vision [121](#)
- Personal Profile [35](#)
- Pinch protection system, glass sunroof [49](#)
- Pinch protection system, windows [47](#)
- Plastic, care [246](#)
- Power failure [238](#)
- Power windows [46](#)
- Pressure, tire air pressure [211](#)
- Pressure warning FTM, tires [110](#)
- Preventing Auto Start Stop [70](#)
- Profile, refer to Personal Profile [35](#)
- Programmable memory buttons, iDrive [24](#)
- Protective function, glass sunroof [49](#)
- Protective function, windows [47](#)
- Push-and-turn switch, refer to Controller [18, 19](#)
- ## Q
- Queuing Assistant, see Congestion Assistant [145](#)
- ## R
- Radiator fluid [227](#)
- Radio-operated key, refer to Remote control [34](#)
- Radio ready state [67](#)
- Radio, see user's manual for Navigation, Entertainment and Communication
- Rain sensor [75](#)
- Rear automatic climate control [169](#)
- Rear center armrest [184](#)
- Rear drink holder [185](#)
- Rear lamps [235](#)
- Rear socket [179](#)
- Rear ventilation, third row of seats, ventilation, third row of seats [169](#)
- Rearview mirror [60](#)
- Rear window defroster [167](#)
- Recirculated-air mode [167](#)
- Recommended tire brands [219](#)
- Refueling [204](#)
- Remaining range [89](#)
- Remote control/key [34](#)
- Remote control, malfunction [39](#)
- Remote control, parked-car heating/ventilation [172](#)
- Remote control, universal [175](#)
- Replacement fuse [238](#)
- Replacing parts [231](#)
- Replacing wheels/tires [218](#)
- Reporting safety defects [9](#)
- RES button [141](#)
- Reserve warning, refer to Range [89](#)
- Reset, Tire Pressure Monitor TPM [108](#)
- Residual heat, automatic climate control [167](#)
- Retaining straps, securing cargo [195](#)
- Retreaded tires [219](#)
- Roadside parking lamps [100](#)
- Roller sunblinds [48](#)
- RON gasoline quality [206](#)
- Roof load capacity [250](#)
- Roof-mounted luggage rack [196](#)
- Rope for tow-starting/towing [243](#)
- RSC Run Flat System Component, refer to Run-flat tires [220](#)

Rubber components, care [246](#)  
Run-flat tires [220](#)

## S

Safe braking [192](#)  
Safety [7](#)  
Safety belt reminder for driver's seat and front passenger seat [56](#)  
Safety belts [55](#)  
Safety belts, care [246](#)  
Safety Package, refer to Active Protection [128](#)  
Safety switch, windows [47](#)  
Safety systems, airbags [104](#)  
Saving fuel [197](#)  
Screen, refer to Control Display [18](#)  
Screwdriver [231](#)  
Screw thread for tow fitting [243](#)  
Seat belts, refer to Safety belts [55](#)  
Seat heating, front [53](#)  
Seat heating, rear [55](#)  
Seating position for children [63](#)  
Seat, mirror, and steering wheel memory [59](#)  
Seats [50](#)  
Seat ventilation, front [53](#)  
Selection list in instrument cluster [93](#)  
Selector lever, automatic transmission [78](#)  
Self-leveling suspension, air suspension [135](#)  
Self-leveling suspension, malfunction [135](#)  
Sensors, care [247](#)  
Service and warranty [8](#)  
Service requirements, Condition Based Service CBS [229](#)

Service requirements, display [90](#)  
Service, Roadside Assistance [240](#)  
Services, ConnectedDrive Settings, locking/unlocking [44](#)  
Settings on Control Display [95](#)  
Settings, storing for seat, mirrors, steering wheel [59](#)  
Shifting, automatic transmission [78](#)  
Shift paddles on steering wheel [80](#)  
Shoulder support [53](#)  
Side airbags [104](#)  
Signaling, horn [14](#)  
Signals when unlocking [44](#)  
Sitting safely [50](#)  
Size [250](#)  
Ski and snowboard bag [181](#)  
Slide/tilt glass roof [48](#)  
Smoker's package [177](#)  
Snow chains [220](#)  
Socket [178](#)  
Socket, OBD Onboard Diagnostics [229](#)  
Soot particulate filter [191](#)  
SOS button [239](#)  
Spare fuse [238](#)  
Specified engine oil types [225](#)  
Speed, average [94](#)  
Speed limit detection, on-board computer [94](#)  
Speed limiter, display [91](#)  
Speed Limit Information [91](#)  
Speed limit in the computer [94](#)  
Split screen [24](#)  
SPORT+ - program, Dynamic Driving Control [136](#)  
Sport automatic transmission [80](#)

Sport displays, torque display, performance display [95](#)  
SPORT program, driving dynamics [137](#)  
Sport program, transmission [79](#)  
Stability control systems [131](#)  
Start/stop, automatic function [69](#)  
Start/Stop button [67](#)  
Start function during malfunction [35](#)  
Starting the engine [68](#)  
Status display, tires [107](#)  
Status information, iDrive [23](#)  
Status of Owner's Manual [6](#)  
Steering, Active Steering [134](#)  
Steering wheel, adjusting [61](#)  
Steering wheel heating [62](#)  
Steering wheel memory [59](#)  
Steptronic, automatic transmission [78](#)  
Stopping the engine [68](#)  
Storage compartment on the center console [183](#)  
Storage compartments [182](#)  
Storage compartments, locations [182](#)  
Storage, tires [220](#)  
Storing the vehicle [247](#)  
Summer tires, tread [218](#)  
Sun visor [181](#)  
Supplementary text message [87](#)  
Surround View [153](#)  
Suspension settings [135](#)  
Switch for Dynamic Driving Control [135](#)  
Switch, refer to Cockpit [14](#)  
Symbols [6](#)  
Symbols in the status field [23](#)  
SYNC program, automatic climate control [167](#)

**T**

Tachometer [88](#)  
Tailgate [40](#)  
Tailgate, automatic [40](#)  
Tail lamps [235](#)  
Technical changes, refer to Safety [7](#)  
Technical data [250](#)  
Telephone, see user's manual for Navigation, Entertainment and Communication  
Temperature, automatic climate control [166](#)  
Temperature display, external temperature [89](#)  
Temperature, engine oil [88](#)  
Terminal, starting aid [241](#)  
Text message, supplementary [87](#)  
Theft alarm system, refer to Alarm system [45](#)  
Theft protection, refer to Central locking system [37](#)  
Thermal camera, refer to Night Vision [121](#)  
Thigh support [52](#)  
Third row of seats [55](#)  
Tilt alarm sensor [46](#)  
Time of arrival [94](#)  
Tire damage [218](#)  
Tire identification marks [216](#)  
Tire inflation pressure [211](#)  
Tire inflation pressure monitor, refer to FTM [110](#)  
Tire Pressure Monitor TPM [107](#)  
Tires, changing [218](#)  
Tires, everything on wheels and tires [211](#)  
Tires, run-flat tires [220](#)  
Tire tread [218](#)  
Tone, see user's manual for Navigation, Entertainment and Communication  
Tools [231](#)

Top View [156](#)  
Total vehicle weight [250](#)  
Touchpad [21](#)  
Tow fitting [243](#)  
Towing [242](#)  
Tow-starting [242](#)  
TPM Tire Pressure Monitor [107](#)  
Traction control [133](#)  
TRACTION program, Dynamic Driving Control [136](#)  
Transmission, automatic [78](#)  
Transporting children safely [63](#)  
Tread, tires [218](#)  
Trip computer [95](#)  
Triple turn signal activation [74](#)  
Trip odometer [89](#)  
Turning circle lines, rearview camera [154](#)  
Turn signals, operation [74](#)

**U**

Unintentional alarm [46](#)  
Units of measure [96](#)  
Universal remote control [175](#)  
Unlock button, automatic transmission [79](#)  
Unlocking/locking from inside [40](#)  
Unlocking/locking via door lock [39](#)  
Unlocking/locking with remote control [38](#)  
Unlocking, settings [44](#)  
Unpaved roads, cross-country trips [193](#)  
Updates made after the editorial deadline [6](#)  
Upholstery care [246](#)  
USB interface [179](#)

**V**

Variable steering [134](#)  
Vehicle battery [237](#)  
Vehicle battery, replacing [237](#)  
Vehicle, breaking in [190](#)  
Vehicle care [245](#)  
Vehicle equipment [6](#)  
Vehicle identification number, refer to Identification number in the engine compartment [222](#)  
Vehicle jack [235](#)  
Vehicle paint [245](#)  
Vehicle storage [247](#)  
Vehicle wash [244](#)  
Ventilation [168](#)  
Vertical Dynamic Control [135](#)  
Voice activation system [26](#)

**W**

Warning indicators [86](#)  
Warning lamps [86](#)  
Warning messages, refer to Check Control [86](#)  
Warning triangle [240](#)  
Washer fluid [77](#)  
Washer nozzles, windshield [76](#)  
Washer system [75](#)  
Washing, vehicle [244](#)  
Water on roads [191](#)  
Weights [250](#)  
Welcome lamps [99](#)  
Wheel cleaner [246](#)  
Wheels, changing [218](#)  
Wheels, everything on wheels and tires [211](#)  
Wheels, Flat Tire Monitor FTM [110](#)  
Wheels, Tire Pressure Monitor TPM [107](#)  
Window defroster, rear [167](#)  
Windows, powered [46](#)

Windshield, climate control [191](#)  
Windshield washer fluid [77](#)  
Windshield washer nozzles [76](#)  
Windshield washer system [75](#)  
Windshield wiper [75](#)  
Windshield wipers, fold-out position [77](#)  
Winter diesel [207](#)  
Winter storage, care [247](#)  
Winter tires, suitable tires [219](#)  
Winter tires, tread [218](#)  
Wiper blades, replacing [231](#)  
Wiper fluid [77](#)  
Wiper system [75](#)  
Wood, care [246](#)  
Word match concept, navigation [25](#)  
Wrench [231](#)

## X

xDrive [133](#)  
Xenon headlamps, bulb replacement [233](#)





More about BMW



The Ultimate Driving  
Machine

[bmwusa.com](http://bmwusa.com)

01 40 2 926 740 ue

